

Pumps | Sampling | Plastic Labware  
for Laboratory, Industry, Science

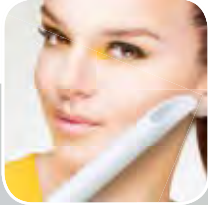

2016

## What's new?

Our product lines **LaboPlast®** and **SteriPlast®** have been comprehensively expanded, for example with our new **DispoSamplers** (from page 121). They are cleanroom manufactured

**LaboPlast**

and individually packaged and therefore meet the highest standards for sampling liquids, viscous media, powders and granules.

Each of these disposable samplers is also available in a sterile version.

**SteriPlast**

The proven **sample scoops LaboPlast®** (page 141) and **SteriPlast®** (page 129) are now also available with sizes 250 ml and 500 ml, for even more flexibility in sampling.

For precise dosing and exact fine titration, Bürkle titrating burettes have been proven for many years. From now on, we are offering an additional version: our new **splinter-proof titrating burette** (page 219)! The precise glass burette has a plastic sheathing which increases resistance to breaking. And if it does break, there will be no dangerous splinters.

The Bürkle catalogue is packed full of many useful products for all aspects of filling hazardous liquids and manual sampling, a large number of containers, as well as plastic industrial and lab equipment.

As always, you will also find helpful and more detailed information for many items throughout the catalogue, all designed to provide support for you in selecting products and in your work.



**You Tube** Do you prefer moving images of our Bürkle products? – No problem! Visit us at [www.buerkle.de/videos](http://www.buerkle.de/videos) or simply scan the code opposite with your smartphone and select the films that you find interesting.



+49 7635 8 27 95-0



+49 7635 8 27 95-31



[info@buerkle.de](mailto:info@buerkle.de)



[www.buerkle.de](http://www.buerkle.de)



Follow us on Facebook:  
[www.facebook.com/buerkle.de](https://www.facebook.com/buerkle.de)



Our Youtube channel:  
[www.buerkle.de/videos](http://www.buerkle.de/videos)



**Bürkle GmbH**  
Rheinauen 5  
79415 Bad Bellingen

**Our General Terms and Conditions apply to all orders. You can read them on the Internet and print them at [www.buerkle.de](http://www.buerkle.de)**



## Contents

- 3** Pumps  
Container pumps, barrel pumps, barrel connectors, thread adapters, electric pumps, stopcocks, spigots, ball valves, dosage pumps
- 62** Samplers  
Samplers for bulk goods, samplers for viscous substances, samplers for liquids, samplers for pharmaceutical products, disposable & sterile samplers, ice and meat sampling, soil sampling
- 154** Containers  
Bottles, spray bottles, wash bottles and dropping bottles, boxes, canisters, wide-mouth containers, storage containers, stacking containers, tubs, big containers, safety containers, packaging containers
- 198** Industrial & laboratory equipment  
Trays, bowls, buckets, draining racks, burettes, dispensers, funnels, graduated beakers, pipettes, pipette controllers, tubings, flow indicators, hose connectors, hose clamps, valves, rapid couplings, threaded fittings, protective equipment, accessories for laboratory equipment

## Table of contents pumps



10 – 16

Container pumps

17 – 33

Barrel pumps

17 – 19

Barrel pumps for acids and alkalis

20 – 25

Barrel pumps for flammable liquids

26 – 29

Accessories for pumps

27 – 29

Barrel connectors, thread adapters

34 – 41

Electric pumps

40 – 41

Double-diaphragm pumps, magnetic centrifugal pumps

41 – 42

Airjet compressor, siphon

44 – 52

Stopcocks, spigots, ball valves, IBC discharge valves

53 – 56

Dosage pumps

57 – 61

Accessories for pumps





## Pumps

Pumps, stop cocks, dosing machines

## Fill off liquids – but do it safely

### Safety is the top priority

Dangerous liquids must never be filled off by directly pouring them out. Even the use of a funnel does not provide the required degree of safety when bottling dangerous liquids.

- ▶ Increased accident risk by slipping on dirty floors.
- ▶ Skin diseases or poisoning by spilt chemicals.
- ▶ Health hazard from harmful vapours.

Safety during bottling must be the number one priority – for your own personal protection!



This means that purchasing a suitable pump for filling off hazardous liquids is an investment in the safety and health of your employees which pays for itself in a very short time.

### Choosing the right pump

Apart from the size and type of the container, the required pump capacity and the suitability of the pump for the particular medium are important considerations for choosing the right pump. The pump does not only have to be resistant to the medium to be bottled, but specific occupational safety and environmental protection regulations must also be considered.

### Pump capacity

Electric pumps are the first choice for filling off large quantities at a fixed location. Their higher pumping capacity saves times and requires less manual effort. However, the purchase of an expensive electric barrel pump does not always pay for itself; there is often no on-site mains supply, e.g. in the open air, during assembly or in the equipment storage facility. Manual pumps are an interesting alternative to electric pumps for filling off small quantities due to their independence from a power supply and because they mean value for money.

Bürkle offers a wide range of pumping devices for manually removing liquids from containers, canisters, drums and tanks.

### Container size and container type

Pumps that work according to the excess pressure principle are suitable for filling off the required quantities from canisters and small drums up to a capacity of approx. 60 litres. Air is pumped into the container using a pumping ball or pumping piston. This creates excess pressure in the container and the liquid is transported out via the immersion tube.

Barrel pumps are suitable for larger barrels and open containers. They draw in the liquid and then eject it. This family of pumps is characterised by their robust construction with a good pumping capacity and simple handling. Different immersion tube lengths mean



combination with an adapter. On the other hand, universal solutions such as conical drum stoppers can be used.

## Materials

The most suitable pumps are robust industrial pumps made from top-quality materials such as polypropylene (PP) for acids and alkalis, or stainless steel V2A (1.4301) for flammable liquids. We always recommend the use of PTFE seals. Always check that the material is resistant to the medium to be pumped.

In many cases, a check against the chemical resistance list will help.

## Caution with filling aids

Plastic siphons are a cost-effective alternative to mechanical pumps. Siphons are easy-to-use devices for safely filling off liquids from a higher container into a lower one. However, using them for aggressive or flammable liquids cannot be recommended. The pump bellows could be affected by acids and become brittle.



that the pumps fit all the usual commercially available containers. Low-mounted suction valves ensure that almost all the residual liquid is removed.

## Container connections

In contrast to metal drums, which usually have an R2" fine thread, there are no standard connection threads for plastic drums. There are basically two different ways of attaching the pump to the drum or container. On the one hand, the pump can be screwed onto the existing container thread using a barrel screw joint, possibly in com-



## Acids and alkalis

Acids, alkalis and detergents can be safely handled by plastic pumps made of PP or PVDF. Bürkle offers many plastic pumps with both rigid discharge pipes and also with discharge tubing and shut-off valve for filling containers which are further away or higher up. When handling corrosive or aggressive liquids, the user must take appropriate precautions. Protective clothing such as gloves, goggles, aprons and face masks is essential.

## Flammable liquids

Filling off flammable liquids requires special precautionary measures. It is essential that filling devices for flammable liquids are made of conductive materials. It is essential that any electrostatic charges formed are eliminated completely and without forming sparks. Stainless steel barrel pumps meet these requirements when the electrostatic charges are eliminated by using the Anti-static Set.

## Gas-tight bottling

With volatile media, such as acetone or ammonia, hazardous vapours are formed in the container. Their evaporation into the working environment and the risk to the user can be reduced by using a gas-tight barrel connector. With particularly toxic, noxious and readily volatile media, a closed filling system with a gas-shuttle pipe is essential. In this method, the gases displaced from the container are returned directly into the original container. The harmful gases remain in the system; the greatest possible degree of safety during filling off is guaranteed.

## Foodstuffs

If foodstuffs are to be filled off, then it must be ensured that the materials used are physiologically harmless. Materials such as stainless steel, polypropylene or PTFE, which also have a neutral taste and odour, can be recommended. Furthermore, the pump must be easy to clean.

## Any questions?

We will be happy to advise you. Talk to us - telephone +49 7635 82795-0, or send an email to [info@buerkle.de](mailto:info@buerkle.de).



# Overview of pumps

|  | Page  | Liquids | Pastes | Gases | Acids and caustic solutions | Acids and caustic solutions, weak | Mineral oils, Diesel etc. | Petrochemicals | Pharmaceuticals/cosmetics | Solvents, not flammable | Solvents, flammable | Flammable liquids | Foodstuffs | Water | Dosing pumps | Gaslight decanting | Bottles up to 2 liters | Canisters up to 20 liters | Laboratory barrels 10/25 liters | Containers up to 60 liters | Barrels up to 220 liters | Open container/tanks | Conveying capacity l/min | Conveying capacity l / stroke |
|--|-------|---------|--------|-------|-----------------------------|-----------------------------------|---------------------------|----------------|---------------------------|-------------------------|---------------------|-------------------|------------|-------|--------------|--------------------|------------------------|---------------------------|---------------------------------|----------------------------|--------------------------|----------------------|--------------------------|-------------------------------|
| OTAL® liquid transfer pumps                  | 8     | x       |        |       | x                           | x                                 |                           | x              | x                         | x                       |                     |                   | x          | x     |              |                    | x                      | x                         | x                               | x                          |                          |                      | 4                        |                               |
| OTAL® mini pump                              | 11    | x       |        |       | x                           | x                                 |                           | x              | x                         |                         |                     |                   | x          | x     |              |                    | x                      | x                         | x                               |                            |                          |                      | 4                        |                               |
| OTAL® battery pump                           | 11,13 | x       |        |       |                             | x                                 |                           |                |                           |                         |                     |                   |            | x     |              |                    |                        | x                         | x                               |                            |                          |                      | 5                        |                               |
| Pump-it® container pump                      | 14    | x       |        |       |                             | x                                 |                           | x              |                           |                         |                     |                   |            | x     |              |                    |                        | x                         | x                               | x                          |                          |                      | 12-26                    |                               |
| PumpMaster for chemical liquids              | 15    | x       |        |       | x                           | x                                 |                           |                | x                         |                         |                     |                   |            | x     |              |                    |                        | x                         | x                               | x                          |                          |                      | 8                        |                               |
| PumpMaster for petrochemical liquids         | 15    | x       |        |       |                             |                                   | x                         | x              | x                         |                         |                     |                   |            | x     |              |                    |                        | x                         | x                               | x                          |                          |                      | 8                        |                               |
| PumpMaster container and barrel pump         | 15    | x       |        |       |                             |                                   |                           |                | x                         |                         |                     |                   |            | x     |              |                    |                        | x                         | x                               | x                          |                          |                      | 8                        |                               |
| Dosi-Pump                                    | 16    | x       |        |       |                             | x                                 |                           |                | x                         |                         |                     |                   | x          | x     | x            |                    | x                      | x                         | x                               |                            |                          |                      |                          | 4-250                         |
| Barrel pump Ultrapure in PTFE                | 17    | x       |        |       | x                           | x                                 |                           | x              | x                         |                         |                     |                   |            | x     |              |                    |                        | x                         | x                               | x                          | x                        | x                    |                          | 300-400                       |
| Barrel pump in PP                            | 18    | x       |        |       | x                           | x                                 |                           |                | x                         |                         |                     |                   | x          | x     |              |                    |                        | x                         | x                               | x                          | x                        | x                    | 12                       | 200-300                       |
| Stainless steel barrel pump                  | 20    | x       |        |       |                             |                                   | x                         | x              | x                         |                         | x                   | x                 | x          | x     |              |                    |                        | x                         | x                               | x                          | x                        |                      |                          | 9-22                          |
| Solvent pump Mini                            | 22    | x       |        |       |                             |                                   | x                         | x              | x                         |                         | x                   | x                 | x          | x     |              | x                  | x                      |                           |                                 |                            |                          |                      |                          | 1,8                           |
| Solvent pump foot operated                   | 24    | x       |        |       |                             |                                   | x                         | x              | x                         |                         | x                   | x                 | x          | x     |              | x                  |                        |                           | x                               | x                          | x                        |                      |                          | 30                            |
| Solvent pump hand operated                   | 25    | x       |        |       |                             |                                   | x                         | x              | x                         |                         | x                   | x                 | x          | x     |              | x                  |                        | x                         | x                               | x                          |                          |                      |                          | 10                            |
| Anti-static set                              | 26    |         |        |       |                             |                                   |                           |                |                           |                         | x                   | x                 |            |       |              |                    |                        |                           |                                 |                            |                          |                      |                          |                               |
| Gas-tight barrel pump in stainless steel     | 30    | x       |        |       |                             |                                   | x                         | x              |                           |                         | x                   | x                 |            | x     |              | x                  |                        | x                         | x                               | x                          | x                        |                      |                          | 350-560                       |
| Gas-tight barrel pump in PP                  | 30    | x       |        |       | x                           | x                                 |                           |                |                           |                         |                     |                   |            | x     |              | x                  |                        | x                         | x                               | x                          |                          |                      |                          | 200                           |
| Rotary piston pump                           | 31    | x       |        |       |                             |                                   | x                         | x              |                           | x                       |                     | x                 |            | x     |              |                    |                        |                           |                                 | x                          | x                        |                      |                          | 30-40                         |
| Lever pump                                   | 32    | x       |        |       |                             | x                                 | x                         | x              |                           |                         |                     |                   |            | x     |              |                    |                        | x                         | x                               | x                          | x                        | x                    |                          | 350                           |
| Compact lever pump                           | 33    | x       |        |       |                             | x                                 |                           |                |                           |                         |                     |                   |            | x     |              |                    |                        |                           |                                 | x                          | x                        |                      |                          | 300                           |
| Piston pump                                  | 33    | x       |        |       |                             | x                                 | x                         | x              |                           |                         |                     |                   |            | x     |              |                    |                        |                           |                                 | x                          | x                        |                      |                          | 450                           |
| Barrel pumps AccuOne and EnergyOne           | 34    | x       |        |       | x                           | x                                 |                           |                | x                         |                         |                     |                   |            | x     |              |                    |                        | x                         | x                               | x                          | x                        | x                    |                          | 0,4-12                        |
| Laboratory pump mains operated               | 36    | x       |        |       | x                           | x                                 |                           |                | x                         |                         |                     |                   |            | x     |              |                    |                        |                           |                                 | x                          | x                        | x                    |                          | 40-65                         |
| Electric barrel pump petro                   | 37    | x       |        |       |                             |                                   | x                         | x              |                           |                         |                     | x                 |            |       |              |                    |                        |                           |                                 |                            | x                        | x                    |                          | 40                            |
| Drum pump for concentrated acids and alkalis | 38    | x       |        |       | x                           | x                                 |                           |                | x                         |                         |                     |                   |            | x     |              |                    |                        |                           |                                 |                            | x                        | x                    |                          | 80                            |
| Drum pump for slight acids and alkalis       | 38    | x       |        |       |                             | x                                 |                           |                | x                         |                         |                     |                   |            | x     |              |                    |                        |                           |                                 |                            | x                        | x                    |                          | 85                            |
| Drum pump for mineral oils                   | 39    | x       |        |       |                             |                                   | x                         | x              |                           |                         |                     | x                 |            | x     |              |                    |                        |                           |                                 |                            | x                        | x                    |                          | 85                            |
| Double-diaphragm pump                        | 40    | x       |        |       | x                           | x                                 |                           | x              |                           |                         |                     |                   |            | x     |              |                    |                        |                           |                                 |                            |                          |                      |                          | 16                            |
| Magnetic centrifugal pump                    | 41    | x       |        |       | x                           | x                                 |                           |                |                           |                         |                     |                   |            | x     |              |                    |                        |                           |                                 |                            |                          |                      |                          | 12-24                         |
| Membrane vacuum pump                         | 41    | x       |        | x     |                             |                                   |                           |                |                           |                         |                     |                   |            |       |              |                    |                        |                           |                                 |                            |                          |                      |                          | 16                            |
| Siphon                                       | 42    | x       |        |       |                             | x                                 |                           | x              |                           |                         |                     |                   |            | x     | x            |                    |                        | x                         | x                               | x                          | x                        | x                    |                          | 9                             |
| Stop-cocks and ball valves                   | 44    | x       |        |       | x                           | x                                 | x                         | x              | x                         | x                       | x                   | x                 | x          | x     |              |                    | x                      | x                         | x                               | x                          | x                        | x                    |                          |                               |
| Barrel valve                                 | 51    | x       |        |       |                             |                                   |                           |                |                           |                         |                     |                   |            |       |              |                    |                        |                           |                                 |                            | x                        |                      |                          |                               |
| Wall mounted dosing machine                  | 53    | x       |        |       |                             |                                   | x                         | x              | x                         | x                       |                     |                   |            | x     | x            |                    |                        | x                         | x                               | x                          | x                        | x                    |                          | 100-500                       |
| LiquoFill                                    | 54    | x       |        |       |                             |                                   | x                         | x              |                           |                         |                     |                   | x          | x     | x            |                    |                        | x                         | x                               | x                          | x                        | x                    |                          | 8-500                         |
| PastoFill                                    | 56    |         | x      |       |                             |                                   |                           |                | x                         |                         |                     |                   | x          | x     | x            |                    |                        |                           |                                 |                            |                          |                      |                          | 10-260                        |

Attention! Make sure to pay attention to the "List of Chemical Resistance"! Errors and omissions excepted.



## OTAL® liquid transfer pumps | filling off liquids quickly, safely and cleanly

The OTAL® pump program has been on the market for 60 years. The pumps are popular and appreciated thanks to their easy handling in daily use.

Thanks to the simple stopper system, OTAL® pumps can be used for all common containers. The OTAL® Mini allows even very small containers to be filled.

Only the tube comes into contact with the liquid when OTAL® pumps are used, so that a great deal of liquid can be filled off using the tube materials PP, PVDF and stainless steel V2A. The different tube diameters make individual adjustments to required transfer volumes possible.

The OTAL® foot pump has another great advantage, particularly when filling aggressive media. It is designed so that both hands are free during the pumping process.

- ▶ Optionally available as a foot or hand pump
- ▶ Universal bungs for container openings of 30 – 70 mm diameter
- ▶ Tubes made of PP, PVDF or stainless steel V2A for different liquids



### The bung has to fit!

Filling with the proven OTAL® pumps is particularly easy as the liquid is forced out of the container by the excess air pressure. The liquid flow is steady, without pulsating. However, it is important that the connection between the pump and the container is airtight. This is ensured by the universal bung made of soft PVC.

The universal bung consists of 3 parts, a conical centre (1) and 2 conical sleeves (2 and 3) which can be moved up and down the conical centre. This means that it is possible to obtain an airtight seal between OTAL® pumps and container openings with a diameter of 30 to 70 mm.



⚠ Instructions for use and safety information must be complied with. Protective clothing must be worn. See pages 58 - 61.

## OTAL® hand pumps | to fit most commercial storage drums

The telescopic immersion tube adapts itself to the container height on insertion. This ensures good removal of residual liquid and means that the hand pump can be used with different containers.

- ▶ Particularly compact, space-saving hand pump
- ▶ Good pump capacity
- ▶ With universal bungs made of soft PVC, for container openings of 30 - 70 mm Ø

⚠ Attention! Make sure to pay attention to the "List of Chemical Resistance"!



# OTAL® hand pumps | to fit most commercial storage drums



### ① OTAL® hand pump made of PP

OTAL® hand pumps with PP delivery tubes, resistant to weak acids, alkalis and detergents.

### ② OTAL® hand pump made of PVDF

OTAL® hand pump with PVDF delivery tubes, particularly suitable for acids and alkalis, not for heavily oxidising acids and alkalis. With its special material properties, PVDF has an even better chemical resistance than PP. Resistant to chlorine bleach.

### ③ OTAL® hand pump made of stainless steel

OTAL® hand pump with delivery tubes made of stainless steel (1.4301) for liquids that are not easily combustible in Hazard Category AIII (VbF). The OTAL® PP or PVDF hand pump should be used for caustic media.

④ **OTAL® hand pump with hose and stopcock**  
OTAL® hand pump with hose and tap with discharge hose with a length of 1.5 m made of PVC and PP/PE stopcock, delivery tube made of PP. The discharge hose is particularly suited to fill distant containers.

### ⑤ OTAL® mini pump made of PP

OTAL® PP mini pump with delivery tubes made of PP and universal bungs made of soft PVC.

- ▶ For small containers, ideal for containers up to 10 litres
- ▶ With universal bungs for container openings of 20 - 36 mm Ø

### ⑥ OTAL® battery-pump

OTAL® pump for safe filling of car batteries with acid or distilled water.

- ▶ With hose shutoff valve
- ▶ With dosing tip for precise filling

| OTAL® hand pump |                              |           |                        |                     |         |                      |               |              |  |
|-----------------|------------------------------|-----------|------------------------|---------------------|---------|----------------------|---------------|--------------|--|
|                 | Pump capacity approx. l/ min | Tube Ø mm | Delivery tube material | Immer-sion depth cm | Price € | Quan-tity scale from | Scale price € | Item no.     |  |
| ①               | 14                           | 12        | PP                     | 70                  | 67.50   | 10                   | 59.70         | 5005-1200 N4 |  |
| ①               | 20                           | 15        | PP                     | 70                  | 70.80   | 10                   | 65.30         | 5005-1500 N4 |  |
| ①               | 26                           | 18        | PP                     | 70                  | 72.00   | 10                   | 64.80         | 5005-1800 N4 |  |
| ②               | 20                           | 16        | PVDF                   | 70                  | 121.50  | 10                   | 111.30        | 5005-3000 N4 |  |

| OTAL® hand pump |                              |           |                        |                     |         |                      |               |              |  |
|-----------------|------------------------------|-----------|------------------------|---------------------|---------|----------------------|---------------|--------------|--|
|                 | Pump capacity approx. l/ min | Tube Ø mm | Delivery tube material | Immer-sion depth cm | Price € | Quan-tity scale from | Scale price € | Item no.     |  |
| ③               | 26                           | 18        | V2A                    | 90                  | 121.50  | 10                   | 111.30        | 5005-4000 N4 |  |
| ④               | 12                           | 12        | PP/PVC                 | 70                  | 70.80   | 10                   | 63.00         | 5005-6000 N4 |  |
| ⑤               | 4                            | 10        | PP                     | 45                  | 49.35   | 10                   | 44.55         | 5005-1000 N4 |  |
| ⑥               | 5                            | 12        | PP/PVC                 | 70                  | 77.60   | 10                   | 69.80         | 5005-7000 N4 |  |

## OTAL® foot pumps | high performance, sturdy, for industrial use



The telescopic immersion tube adapts itself to the container height on insertion of the foot pump. This ensures good removal of residual liquid and means that the foot pump can be used with different containers.

- ▶ Simple handling: Both hands remain free for filling
- ▶ Very good pump capacity due to large volume foot bellows
- ▶ With universal bungs made of soft PVC, for container openings of 30 - 70 mm Ø

 Attention! Make sure to pay attention to the "List of Chemical Resistance"!

# OTAL® foot pumps | high performance, sturdy, for industrial use



## ① OTAL® foot pump made of PP

OTAL® foot pumps with delivery tubes made of PP, resistant to weak acids, alkalis and detergents.

## ② OTAL® foot pump made of PVDF

OTAL® foot pump with delivery tubes made of PVDF, particularly for acids and alkalis, not for heavily oxidising acids and alkalis. Resistant to chlorine bleach. With its special material properties, PVDF has an even better chemical resistance than PP.

## ③ OTAL® foot pump made of stainless steel

OTAL® foot pump made of stainless steel (1.4301), with delivery tubes made of stainless steel for liquids that are not easily combustible in Hazard Category AIII (VbF).

## ④ OTAL® foot pump with hose and stopcock

OTAL® foot pump with hose and tap with delivery tubes made of PP and a 1.5 m discharge hose made of PVC with stopcock made of PP/PE Ø 10 mm.

## ⑤ OTAL® battery-pump

OTAL® pump for safe filling of car batteries with acid or distilled water.

### ① OTAL® foot pump made of PP

| Pump capacity approx. l/min | Tube Ø mm | Delivery tube material | Immersion depth cm | Price € | Quantity scale from | Scale price € | Item no.     |
|-----------------------------|-----------|------------------------|--------------------|---------|---------------------|---------------|--------------|
| 20                          | 15        | PP                     | 70                 | 83.30   | 10                  | 78.80         | 5000-1500 N4 |
| 26                          | 18        | PP                     | 70                 | 85.60   | 10                  | 77.60         | 5000-1800 N4 |
| 30                          | 22        | PP                     | 90                 | 94.50   | 10                  | 83.30         | 5000-2200 N4 |

| Pump capacity approx. l/min | Tube Ø mm | Delivery tube material | Immersion depth cm | Price € | Quantity scale from | Scale price € | Item no.     |
|-----------------------------|-----------|------------------------|--------------------|---------|---------------------|---------------|--------------|
| ② 20                        | 16        | PVDF                   | 70                 | 128.10  | 10                  | 118.10        | 5000-4016 N4 |
| ③ 26                        | 18        | V2A                    | 90                 | 128.10  | 10                  | 118.10        | 5000-5018 N4 |
| ④ 12                        | 12        | PP/PVC                 | 70                 | 85.60   | 10                  | 77.60         | 5000-3012 N4 |
| ⑤ 5                         | 12        | PP/PVC                 | 70                 | 94.50   | 10                  | 83.30         | 5000-6000 N4 |

## Pump-it® container pump

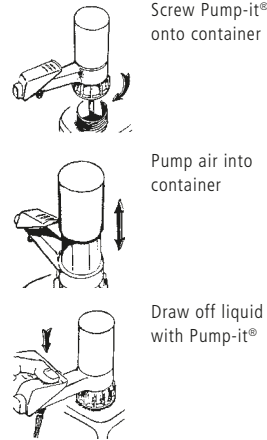

Pump-it® canister pumps are designed for quickly and cleanly emptying canisters and small barrels up to 60 l. The hand pump is used to create excess pressure that forces the liquid out of the canister. Pump-it® is suitable for weak acids, alkalis and petrochemicals.

- ▶ Medium-contacting parts made of PP, PE and FKM
- ▶ Pump threads suitable for container threads 64 mm Ø (BSI)
- ▶ Exact dosing, no drips
- ▶ Container completely emptied, thanks to stepless length adjustment of immersion tube

**⚠** Not suitable for hydrochloric acid! Make sure to pay attention to the "List of Chemical Resistance"!

### Pump-it® container pump

| Material | Immersion depth<br>cm | Pump capacity<br>approx. l/min | Price € | Quantity scale<br>from | Scale price € | Item no.     |
|----------|-----------------------|--------------------------------|---------|------------------------|---------------|--------------|
| PP/FKM   | 100                   | 8                              | 110.90  | 10                     | 99.85         | 5201-1000 N4 |



### Accessories

| Description   | Price € | Item no.     |
|---|---------|--------------|
| Adapter set Pump-it® consisting of: 0600-3002, -3003, -3004, -1014, -1016 | 51.20   | 5201-0030 N4 |
| Thread adapters PP outer/outer 2" coarse thread Mauer - 64 mm (BSI)       | 11.65   | 0600-3004 N4 |
| Thread adapters PP outer/outer 2" coarse thread Tri-Sure - 64 mm (BSI)    | 11.65   | 0600-3002 N4 |
| Thread adapters PP outer/outer 2" BSP - 64 mm (BSI)                       | 11.65   | 0600-3003 N4 |
| Thread adapters PP outer/inner 64 mm (BSI) - DIN 60                       | 16.95   | 0600-1014 N4 |
| Thread adapters PP outer/inner 64 mm (BSI) - DIN 51                       | 19.40   | 0600-1016 N4 |
| Thread adapters PP outer/inner 64 mm (BSI) - DIN 61                       | 19.40   | 0600-1013 N4 |
| Thread adapters PP outer/inner 64 mm (BSI) - DIN 71                       | 19.40   | 0600-1001 N4 |

For more adapters, see page 28

## Adapter set Pump-it®



Thread adapter set for Pump-it® canister pump consisting of:

- ▶ Adapter outer/outer, 2" coarse Mauer - 64 mm (BSI), green
- ▶ Adapter outer/outer, 2" coarse Tri-Sure - 64 mm (BSI), brown
- ▶ Adapter outer/outer, 2" BSP - 64 mm (BSI), blue
- ▶ Adapter outer/inner, 64 mm (BSI) - DIN 60, black
- ▶ Adapter outer/inner, 64 mm (BSI) - DIN 51, black

### Adapter set Pump-it®

| Price € | Quantity<br>scale from | Scale price € | Item no.     |
|---------|------------------------|---------------|--------------|
| 51.20   | 10                     | 46.15         | 5201-0030 N4 |

See page 28



# PumpMaster container pumps | flexible, for universal use

The manual pressure pump is ideally suited for drawing off, decanting and emptying canisters and barrels. The hand pump is used to create excess pressure that forces the liquid out of the container. The stopcock also allows extraction of small quantities of liquid. The PumpMaster container pump is mounted on the container using a flexible stopper with a variable and adjustable diameter. No special thread adapters are required. PumpMaster fits all commercial container openings with a diameter from 46.5 mm to 60 mm. The immersion tube has a length of 95 cm and it can be shortened depending on the size of the container.

► Complete with three bungs in different sizes

**!** Make sure to pay attention to the "List of Chemical Resistance"!

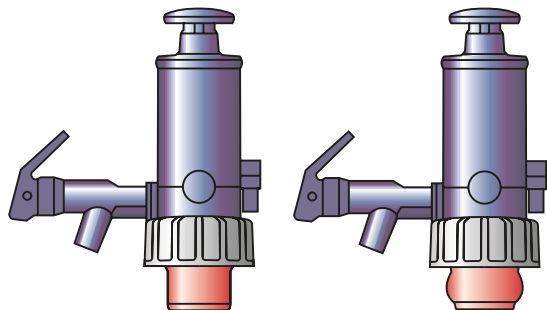

PumpMaster canister barrel pump stopper released

PumpMaster canister barrel pump stopper expanded

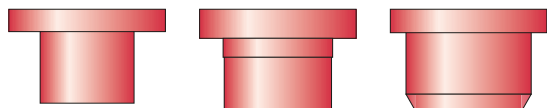

Various stoppers for PumpMaster

| PumpMaster container pump for petrochemical liquids                              |          |           |                             |                    |         |                     |               |           |    |
|--|----------|-----------|-----------------------------|--------------------|---------|---------------------|---------------|-----------|----|
| Gaskets  | Material | Colour    | Pump capacity approx. l/min | Immersion depth cm | Price € | Quantity scale from | Scale price € | Item no.  |    |
| nitrile rubber   | PP/PE    | blue grey | 8                           | 95                 | 132.70  | 10                  | 118.40        | 5202-3000 | N4 |
| Accessories  |          |           |                             |                    |         |                     |               |           |    |
| Description  |          |           |                             |                    |         |                     | Price €       | Item no.  |    |
| Discharge hose with shut-off valve for PumpMaster for petrochemical liquids      |          |           |                             |                    |         |                     | 60.15         | 5202-3001 | N4 |
| PumpMaster container pump for non-aggressive liquids                             |          |           |                             |                    |         |                     |               |           |    |
| Gaskets  | Material | Colour    | Pump capacity approx. l/min | Immersion depth cm | Price € | Quantity scale from | Scale price € | Item no.  |    |
| EPDM   | PP/PE    | red       | 8                           | 95                 | 132.70  | 10                  | 118.40        | 5202-2000 | N4 |
| Accessories  |          |           |                             |                    |         |                     |               |           |    |
| Description  |          |           |                             |                    |         |                     | Price €       | Item no.  |    |
| Discharge hose with shut-off valve for PumpMaster for aqueous liquids            |          |           |                             |                    |         |                     | 58.55         | 5202-2001 | N4 |
| PumpMaster for acids and chemical liquids  |          |           |                             |                    |         |                     |               |           |    |
| Gaskets  | Material | Colour    | Pump capacity approx. l/min | Immersion depth cm | Price € | Quantity scale from | Scale price € | Item no.  |    |
| FKM  | PP/PE    | green     | 8                           | 95                 | 185.55  | 10                  | 176.30        | 5202-1000 | N4 |
| Accessories  |          |           |                             |                    |         |                     |               |           |    |
| Description  |          |           |                             |                    |         |                     | Price €       | Item no.  |    |
| Discharge hose with shut-off valve for PumpMaster for acids and chemical liquids |          |           |                             |                    |         |                     | 82.85         | 5202-1001 | N4 |

# Dosing pumps Dosi-Pump



**Dosi-Pump 4 ml**  
Standard dosage approx. 4 ml per stroke.



**Dosi-Pump 30 ml**  
Standard dosage approx. 30 ml per stroke.



**Dosi-Pump 30 ml fixed feeding tube**  
Standard dosage approx. 30 ml per stroke, the pump has a fixed feeding tube.



**Dosi-Pump 100 ml fixed feeding tube**  
Standard dosage approx. 100 ml per stroke, the pump has a fixed feeding tube.



**Dosi-Pump 250 ml fixed feeding tube**  
Standard dosage approx. 250 ml per stroke, the pump has a fixed feeding tube.

Dosing pumps suitable for barrels, canisters, carboys or bottles, for dosing liquids of different viscosities. Dosing pumps are mounted by you in your existing container closure (see the locating bore table). To do this, a suitable hole is drilled in the cap. Then the pump is inserted through the hole and screwed in place from below.

A matching container connection is not included in the scope of delivery.

- ▶ Medium-contacting parts made of PP, PE and stainless steel

## Dosing pumps Dosi-Pump



|   | Stroke approx. ml | Drill-hole dia. mm | Immersion depth cm | Price € | Quantity scale from | Scale price € | Item no.     |
|---|-------------------|--------------------|--------------------|---------|---------------------|---------------|--------------|
| ① | 4                 | 21                 | 20                 | 7.45    | 100                 | 5.95          | 5607-1004 N3 |
| ② | 30                | 28,5               | 28                 | 11.90   | 100                 | 9.50          | 5607-2030 N3 |
| ③ | 30                | 22,5               | 35,5               | 20.35   | 100                 | 16.30         | 5607-3030 N3 |
| ④ | 100               | 28,5               | 28                 | 64.40   | 100                 | 51.50         | 5607-4100 N3 |
| ⑤ | 250               | 28,5               | 28                 | 80.15   | 100                 | 64.15         | 5607-5250 N3 |



# PTFE barrel pumps Ultrapure



Due to the high chemical resistance of the medium-contacting parts made of PTFE and FEP, even liquids which attack conventional materials such as PP or PVC can now be safely transferred (except for elemental fluorine) with this barrel pump. The barrel pump is also suitable for transferring ultra-pure liquids. The stopcock prevents hazardous vapours from escaping, and stops dripping after transfer.

Barrel pump with rigid discharge tube with stopcock made of PTFE.

Barrel pump with flexible discharge hose made of PTFE, length of 1.2 m and stopcock made of PVDF.

- ▶ Immersion tube Ø 32 mm
- ▶ All valves are made of solid PTFE/PVDF
- ▶ Top quality - 3 years' warranty
- ▶ Barrel screw joints for commercially available containers available as accessories

### PTFE barrel pump Ultrapure - discharge tube

| Immersion depth cm | Pump capacity ml/stroke | Price € | Quantity scale from | Scale price € | Item no.     |
|--------------------|-------------------------|---------|---------------------|---------------|--------------|
| 60                 | 270                     | 334.35  | 10                  | 321.10        | 5606-0600 N4 |
| 95                 | 400                     | 362.55  | 10                  | 348.60        | 5606-1000 N4 |

### PTFE barrel pump Ultrapure - discharge hose

| Immersion depth cm | Pump capacity ml per stroke | Price € | Quantity scale from | Scale price € | Item no.     |
|--------------------|-----------------------------|---------|---------------------|---------------|--------------|
| 60                 | 270                         | 334.35  | 10                  | 321.10        | 5606-0601 N4 |
| 95                 | 400                         | 362.55  | 10                  | 348.60        | 5606-1001 N4 |

### Accessories

| Description   | Price € | Item no.     |
|---|---------|--------------|
| PP barrel screw joint, R 2", steel fine outer thread  | 26.10   | 5600-3130 N4 |
| PP barrel screw joint, Mauser 2", coarse outer thread | 32.60   | 5600-3170 N4 |
| PP barrel screw joint, Tri-Sure, coarse outer thread  | 36.70   | 5600-3180 N4 |
| SafetyBox incl. safety goggles and protective gloves  | 38.00   | 2507-9000 N3 |

## PP barrel pumps | robust industrial quality

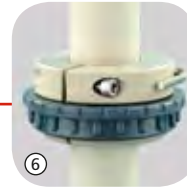

Barrel pumps made of polypropylene allow a fast transfer of liquids from barrels, canisters and tanks. The good chemical resistance of PP allows acids, alkalis and aggressive detergents to be transferred. The low-mounted non-return valve of the barrel pump and the immersion depth that can be steplessly adjusted using the barrel screw joints ensure good removal of residual liquid. The barrel screw joint fastens the barrel's pump securely to the barrel. Barrel screw joints and thread adapters for commercially available containers are available as optional accessories.

 Attention! Make sure to pay attention to the "List of Chemical Resistance"!

# PP barrel pumps | robust industrial quality



## PP barrel pump - discharge tube

PP barrel pump with rigid discharge tube.

## PP barrel pump - discharge hose/stopcock

PP barrel pump with flexible discharge hose made of PVC, length of 1.2 m and stopcock.

- ▶ Seals made of PTFE
- ▶ Immersion tube Ø 32 mm
- ▶ Capacity up to approx. 12l/min
- ▶ For barrels and tanks of 60 - 1000 litres

### ① PP barrel pump - discharge tube

| Immersion depth cm | Pump capacity ml per stroke | Total length cm | Price € | Quantity scale from | Scale price € | Item no.  |    |  |
|--------------------|-----------------------------|-----------------|---------|---------------------|---------------|-----------|----|--|
| 50                 | 200                         | 60              | 129.00  | 5                   | 118.60        | 5600-0501 | N4 |  |
| 65                 | 230                         | 74              | 129.00  | 5                   | 118.60        | 5600-0651 | N4 |  |
| 80                 | 260                         | 90              | 133.55  | 5                   | 122.15        | 5600-0801 | N4 |  |
| 100                | 300                         | 109             | 140.50  | 5                   | 125.55        | 5600-1001 | N4 |  |
| 125                | 300                         | 134             | 163.40  | 5                   | 152.85        | 5600-1251 | N4 |  |
| 150                | 300                         | 159             | 171.70  | 5                   | 165.70        | 5600-1501 | N4 |  |

### ② PP barrel pump - discharge hose/stopcock

| Immersion depth cm | Pump capacity ml per stroke | Total length cm | Price € | Quantity scale from | Scale price € | Item no.  |    |  |
|--------------------|-----------------------------|-----------------|---------|---------------------|---------------|-----------|----|--|
| 50                 | 200                         | 60              | 129.00  | 5                   | 118.60        | 5600-0502 | N4 |  |
| 65                 | 230                         | 74              | 129.00  | 5                   | 118.60        | 5600-0652 | N4 |  |
| 80                 | 260                         | 90              | 133.55  | 5                   | 122.15        | 5600-0802 | N4 |  |
| 100                | 300                         | 109             | 140.50  | 5                   | 125.55        | 5600-1002 | N4 |  |
| 125                | 300                         | 134             | 163.40  | 5                   | 152.85        | 5600-1252 | N4 |  |
| 150                | 300                         | 159             | 171.70  | 5                   | 165.70        | 5600-1502 | N4 |  |

### Accessories

| Description   | Price € | Item no.     |
|---|---------|--------------|
| ③ PP barrel screw joint, R 2", steel fine outer thread  | 26.10   | 5600-3130 N4 |
| ④ PP barrel screw joint, Mauser 2", coarse outer thread | 32.60   | 5600-3170 N4 |
| ⑤ PP barrel screw joint, Tri-Sure, coarse outer thread  | 36.70   | 5600-3180 N4 |

### Accessories

| Description   | Price € | Item no.     |
|---|---------|--------------|
| ⑥ Container screw joint                                   | 32.25   | 5600-3140 N4 |
| ⑦ PVC barrel plug, dia. 40-70 mm (not for EX zone)        | 20.45   | 5600-3150 N4 |
| Discharge hose 1.2 m PVC with stopcock for PP barrel pump | 24.80   | 5600-0100 N4 |
| Drain safety stand (see page 57)                          | 45.30   | 5618-1000 N4 |

## Stainless Steel Barrel Pump | for flammable liquids



The Bürkle barrel pump made of stainless steel (1.4301) is suitable for filling combustible and easily flammable liquids. The barrel pump can conduct electricity and therefore fulfills the requirements for handling flammable liquids in combination with the accessory antistatic set.

The PTFE gaskets ensure long-term and maintenance-free use. Pumping capacity approx. 9 – 22 l/min, dependent on pump length.

The wide range of accessories makes it possible to adapt the pump to very different requirements.

Not suitable for acetone!

When withdrawing flammable liquids, the barrel and pump has to be grounded!  
Use Anti-static set!



# Stainless Steel Barrel Pump | for flammable liquids



## Stainless steel barrel pump - discharge tube

Barrel pump made of stainless steel with discharge tube.

- ▶ Removable discharge tube
- ▶ Immersion tube Ø 32 mm

## Stainless steel barrel pump - discharge hose/stopcock

Barrel pump stainless steel with discharge hose and stopcock made of stainless steel and PTFE, can conduct electricity.

- ▶ Immersion tube Ø 32 mm
- ▶ Removable hose, 1.2 m in length
- ▶ Ball valve made of stainless steel NW 8 mm
- ▶ Discharge nozzle Ø 12.8 mm

### ① Stainless steel barrel pump - discharge tube

| Immersion depth cm | Total length cm | Pump capacity ml per stroke | Price € | Quantity scale from | Scale price € | Item no.  |    |
|--------------------|-----------------|-----------------------------|---------|---------------------|---------------|-----------|----|
| 36                 | 48              | 220                         | 194.00  | 5                   | 174.10        | 5601-0400 | N4 |
| 57                 | 69              | 350                         | 198.75  | 5                   | 178.35        | 5601-0500 | N4 |
| 91                 | 103             | 560                         | 207.50  | 5                   | 188.50        | 5601-0800 | N4 |

### ② Stainless steel barrel pump - discharge hose/stopcock

| Immersion depth cm | Total length cm | Pump capacity ml per stroke | Price € | Quantity scale from | Scale price € | Item no.  |    |
|--------------------|-----------------|-----------------------------|---------|---------------------|---------------|-----------|----|
| 36                 | 48              | 220                         | 322.25  | 5                   | 308.65        | 5601-0401 | N4 |
| 57                 | 69              | 350                         | 330.10  | 5                   | 316.20        | 5601-0501 | N4 |
| 91                 | 103             | 560                         | 340.20  | 5                   | 323.85        | 5601-0801 | N4 |

### Accessories

| Description  | Price € | Item no.     |
|--|---------|--------------|
| ③ Anti-static set                                      | 46.45   | 5602-1000 N4 |
| ④ Brass barrel screw joint R2" steel fine outer thread | 39.90   | 5601-0100 N4 |

### Accessories

| Description   | Price € | Item no.     |
|---|---------|--------------|
| ⑤ Gastight barrel connector R2" steel fine outer thread                                 | 117.70  | 5601-0130 N4 |
| Discharge hose 1.2 m with stainless steel/PTFE stopcock for stainless steel barrel pump | 172.90  | 5601-0090 N4 |
| Discharge tube for stainless steel barrel pump  | 61.85   | 5601-0080 N4 |
| ⑥ PVC barrel plug, dia. 40-70 mm (not for EX zone)                                      | 20.45   | 5600-3150 N4 |
| Drain safety stand (see page 57)  | 45.30   | 5618-1000 N4 |
| PP barrel screw joint, R 2", steel fine outer thread                                    | 26.10   | 5600-3130 N4 |
| PP barrel screw joint, Mauser 2", coarse outer thread                                   | 32.60   | 5600-3170 N4 |
| PP barrel screw joint, Tri-Sure, coarse outer thread                                    | 36.70   | 5600-3180 N4 |
| Universal barrel spanner  | 31.10   | 5690-0090 N4 |
| Casual style safety goggles   | 25.15   | 2502-2010 N3 |

## Mini solvent pump | reliable filling of small quantities



The Mini solvent pump is a high-quality hand pump for small containers such as bottles, canisters and tanks up to about 10 litres. For reliable filling and dosing of solvents and readily flammable liquids.

### Simple principle - highly effective

The hand pump works according to the excess pressure principle. An excess pressure is built up in the container with the pump ball, forcing the liquid outward. In this way only the hose, pumping tube and discharge come in contact with the liquid being filled.

To ensure safety, a pressure relief valve protects the solvent pump against excessive pressure build-up, for example due to sunshine.

### High-quality materials

All parts of this hand pump in contact with medium are manufactured from high-quality and inert materials PTFE and stainless steel (1.4301, 1.4404), which feature excellent chemical resistance. The Mini solvent pump is therefore especially well suited for use with high-purity liquids and readily flammable media such as acetone, isopropanol, ethanol and methanol, etc.

### Filling in hazardous zones

The grounding cable included with delivery can easily be connected to the solvent pump with a bunch plug, thus diverting electrostatic charges so that flammable media can be filled safely.

### Flexible applications

The solvent pump allows for filling from a wide range of container sizes. The flexible PTFE hose that conveys liquid out of the container can be shortened to any length. This ensures ideal residual draining, even from bottles and canisters with a vaulted bottom.

The hand pump has a GL 45 standard connecting thread. With the appropriate thread adapters (accessories), however, it can easily be adapted to containers with thread sizes S 40, GL 38 or GL 32.

- ▶ Ideal for 1-5 l containers
- ▶ Connecting thread GL 45
- ▶ Parts in contact with medium made of PTFE and stainless steel (1.4301, 1.4404)
- ▶ PTFE hose (6x8 mm) 0.4 m
- ▶ Including grounding cable 2 m
- ▶ Adapter available as accessory for S 40, GL 38 and GL 32



## Mini solvent pump | reliable filling of small quantities

### Precise removal of liquids

The self-closing discharge (with auto-stop function) of the Mini solvent pump ensures absolutely precise filling with no dripping at all. Dosing is even easy in very small containers such as test tubes, which present no problems. A hose can optionally be fastened onto the discharge spout (internal Ø 6 mm), thus making it possible to fill the container from a greater distance.

The Mini solvent pump is especially compact and very well balanced, which makes it possible to fill without tipping, even from very small containers.

Thanks to its sturdy design and high-quality materials, the Mini solvent pump consistently ensures neat and reliable filling throughout its long service life, easily and conveniently.



### Mini solvent pump

| Pump capacity approx. l/min | Connector thread | Price € | Item no.     |
|-----------------------------|------------------|---------|--------------|
| 1,8                         | GL 45            | 358.05  | 5603-4000 N4 |

### Accessories

| Description   | Price € | Item no.     |
|---|---------|--------------|
| ① Thread adapter for Mini solvent pump, PTFE, GL45-S40  | 27.75   | 0006-4000 N4 |
| ① Thread adapter for Mini solvent pump, ETFE, GL45-GL38 | 27.75   | 0006-4002 N4 |
| ① Thread adapter for Mini solvent pump, ETFE, GL45-GL32 | 27.75   | 0006-4003 N4 |
| ② Hose cutter   | 7.50    | 0006-9506 N3 |
| Glass sampling bottle 1000 ml, GL 45                    | 12.55   | 5314-0100 N3 |
| Suction hose PTFE on roll 6 x 8 mm, roll with 5 m       | 40.35   | 8804-0608 N3 |

# Solvent pump foot operated



EDELSTAHL®  
**Rost frei**  
STAINLESS STEEL

Solvent pump foot operated for filling of high purity liquids such as solvents. All medium-contacting parts are made of stainless steel (1.4301) and PTFE. Due to the barrel screw joint and the stopcock, the container and the pump can be hermetically sealed. Unwanted vapours can therefore not escape during the filling process.

Massive, long-life industrial version. Clip connection for fast connection and disconnection of the air hose.

- ▶ Immersion tube can be steplessly adjusted to the barrel depth
- ▶ For barrels up to 220 litres
- ▶ Suitable for steel barrels with R 2" thread
- ▶ Thread adapter for commercially available containers and air filters for ultra-pure drawing-off available as accessory

**!** When withdrawing flammable liquids, the barrel and pump have to be grounded! Use Anti-static set!



| Solvent pump foot operated - discharge hose/stopcock |                  |                             |         |              |  |  |  |
|--|------------------|-----------------------------|---------|--------------|--|--|--|
| Immersion depth cm                                   | Connector thread | Pump capacity approx. l/min | Price € | Item no.     |  |  |  |
| 95   | 2"               | 20                          | 554.25  | 5603-3000 N4 |  |  |  |

| Solvent pump foot operated - discharge tube |                  |                             |         |              |  |  |  |
|---|------------------|-----------------------------|---------|--------------|--|--|--|
| Immersion depth cm                          | Connector thread | Pump capacity approx. l/min | Price € | Item no.     |  |  |  |
| 95  | 2"               | 20                          | 413.60  | 5603-1100 N4 |  |  |  |

| Accessories     |         |              |
|-----------------|---------|--------------|
| Description     | Price € | Item no.     |
| Anti-static set | 46.45   | 5602-1000 N4 |

| Accessories  |         |              |
|--|---------|--------------|
| Description  | Price € | Item no.     |
| Air filters for solvent pump, filter class M5, 10 pieces | 26.50   | 0006-6009 N4 |



# Solvent pump hand operated



Hand-operated solvent pump for contamination-free removal of organic solvents and flavouring agents. For containers up to 60 l.  
The pump is gas-tight and completely sealable with two ball valves.

- ▶ Medium-contacting parts made of stainless steel (1.4301) and PTFE
- ▶ Rigid discharge tube with stopcock made of stainless steel/PTFE
- ▶ Suitable for containers with R 2" thread
- ▶ Thread adapter for commercially available containers available as accessory

**!** When withdrawing flammable liquids, the barrel and pump have to be grounded! Use Anti-static set!



Solvent pump for tin-foil canisters fits on pull-out spouts



Anti-static set



## Solvent pump hand operated

| Immersion depth cm | Connector thread | Pump capacity approx. l/min | Price € | Item no.  |    |  |  |
|--------------------|------------------|-----------------------------|---------|-----------|----|--|--|
| 60                 | 2"               | 10                          | 377.70  | 5603-1000 | N4 |  |  |

## Solvent pump hand operated, for tin-foil canisters

| Immersion depth cm | Connector thread   | Pump capacity approx. l/min | Price € | Item no.  |    |  |  |
|--------------------|--------------------|-----------------------------|---------|-----------|----|--|--|
| 60                 | for pull-out spout | 10                          | 397.65  | 5603-2000 | N4 |  |  |

## Accessories

| Description     | Price € | Item no.  |
|-----------------|---------|-----------|
| Anti-static set | 46.45   | 5602-1000 |

## Anti-static set | prevents electrostatic build-up

Conductive containers are connected with the red cable, the black cable makes the earth connection (water pipe, etc.)



Safety Plus: The bare copper wire ensures earthing when pouring into non-conductive containers



When decanting flammable liquids without the machines and containers involved in the process being sufficiently earthed, electrostatic build-up can occur, which for many substances can result in fire or an explosion. Bürkle's Anti-static set ensures easy and reliable earthing. The Anti-static set consists of three colour-coded connecting copper cables with clamps in a handy plastic case.



### Anti-static set

| Price € | Quantity scale from | Scale price € | Item no.     |
|---------|---------------------|---------------|--------------|
| 46.45   | 5                   | 41.85         | 5602-1000 N4 |



## Barrel screw joints



Barrel screw joint made of nickel-plated brass for barrel pump stainless steel. Prevents electro-static charge in combination with the Anti-static set. For the safe transfer of flammable and easily flammable liquids. For containers with R2" steel fine thread inside.



The gas tight barrel screw joint prevents hazardous gases from escaping from the barrel. R2" steel barrel thread, non-return valve with connection 1/8". Nickel-plated brass, seals made of FKM.



Barrel screw joint made of PP for secure connection in the barrel in three different thread models. For drawing off liquids that are not flammable.



Container screw joint to fasten the barrel pump in any location on the side of the container. Also for wide-necked screw caps. The screw joint 2" is screwed on from the inside using lock nut 2". (Mounting holes in the container 60 mm).



Barrel bungs made of PVC, consisting of two parts, therefore can be used for various openings with a diameter from 40-70 mm.

### Brass barrel screw joint

| Thread                      | Price € | Quantity scale from | Scale price € | Item no.  |    |
|-----------------------------|---------|---------------------|---------------|-----------|----|
| R2" steel fine outer thread | 39.90   | 5                   | 35.40         | 5601-0100 | N4 |

### Gastight barrel connector

| Thread                      | Price € | Quantity scale from | Scale price € | Item no.  |    |
|-----------------------------|---------|---------------------|---------------|-----------|----|
| R2" steel fine outer thread | 117.70  | 5                   | 103.45        | 5601-0130 | N4 |

### PP barrel screw joint

| Thread                         | Price € | Quantity scale from | Scale price € | Item no.  |    |
|--------------------------------|---------|---------------------|---------------|-----------|----|
| R 2", steel fine outer thread  | 26.10   | 5                   | 23.55         | 5600-3130 | N4 |
| Mauser 2", coarse outer thread | 32.60   | 5                   | 29.35         | 5600-3170 | N4 |
| Tri-Sure, coarse outer thread  | 36.70   | 5                   | 33.00         | 5600-3180 | N4 |

### Container screw joint

| Opening dia. mm | Price € | Quantity scale from | Scale price € | Item no.  |    |
|-----------------|---------|---------------------|---------------|-----------|----|
| 60              | 32.25   | 5                   | 31.00         | 5600-3140 | N4 |

### PVC barrel plug

| Opening dia. mm | Price € | Quantity scale from | Scale price € | Item no.  |    |
|-----------------|---------|---------------------|---------------|-----------|----|
| 40-70           | 20.45   | 5                   | 18.15         | 5600-3150 | N4 |

# Thread adapters PP



We offer a broad range of thread adapters. This facilitates the secure connection of many of our pumps and discharge cocks to a variety of containers.

You will always find the correct connection thanks to the combination of different adapters.

Do you have any questions about choosing the right thread adapter? Please call us. We are glad to offer assistance.

Instructions for determining the thread can be found on page 264.

|   | External thread                            | Internal thread | Colour      | Price € | Quantity scale from | Scale price € | Item no.     |
|---|--|-----------------|-------------|---------|---------------------|---------------|--------------|
| ① | Tri-Sure                                   | 2" BSP          | orange      | 15.25   | 10                  | 13.55         | 0600-1006 N4 |
| ② | Mauser                                     | 2" BSP          | blue        | 15.25   | 10                  | 13.85         | 0600-1010 N4 |
| ③ | Tri-Sure                                   | Mauser          | red         | 15.25   | 10                  | 13.55         | 0600-1011 N4 |
| ④ | Mauser                                     | Tri-Sure        | purple      | 15.25   | 10                  | 13.55         | 0600-1012 N4 |
| ⑤ | US drum thread                             | 2" BSP          | silver      | 15.25   | 10                  | 13.55         | 0600-1007 N4 |
| ⑥ | 61 mm                                      | 2" BSP          | gray        | 15.25   | 10                  | 13.55         | 0600-1008 N4 |
| ⑦ | 61 mm                                      | 3" coarse       | natural     | 21.90   | 10                  | 20.25         | 0600-1009 N4 |
| ⑧ | 64 mm (BSI)                                | DIN 60          | black       | 16.95   | 10                  | 15.45         | 0600-1014 N4 |
| ⑨ | 64 mm (BSI)                                | DIN 51          | black       | 19.40   | 10                  | 17.40         | 0600-1016 N4 |
| ⑩ | 64 mm (BSI)                                | DIN 61          | yellow/blue | 19.40   | 10                  | 17.40         | 0600-1013 N4 |
| ⑪ | 64 mm (BSI)                                | DIN 71          | brown/blue  | 19.40   | 10                  | 17.40         | 0600-1001 N4 |
|   | Internal thread                            |                 | Colour      | Price € | Quantity scale from | Scale price € | Item no.     |
| ⑫ | 35 mm - 2" BSP                             |                 | black       | 18.35   | 10                  | 16.85         | 0600-2004 N4 |
| ⑬ | 51 mm - 2" BSP                             |                 | green       | 18.35   | 10                  | 16.85         | 0600-2005 N4 |
| ⑭ | DIN 61 - 2" BSP                            |                 | yellow      | 15.25   | 10                  | 13.55         | 0600-2001 N4 |
| ⑮ | 63 mm - 2" BSP                             |                 | white       | 18.35   | 10                  | 16.85         | 0600-2006 N4 |
| ⑯ | DIN 71 - 2" BSP                            |                 | brown       | 15.55   | 10                  | 13.55         | 0600-1003 N4 |
|   | External thread                            |                 | Colour      | Price € | Quantity scale from | Scale price € | Item no.     |
| ⑰ | 61 mm - Tri-Sure                           |                 | black       | 8.80    | 10                  | 7.30          | 0600-3006 N4 |
| ⑱ | 61 mm - 2" BSP                             |                 | black       | 8.80    | 10                  | 7.30          | 0600-3007 N4 |
| ⑲ | 2" coarse Mauser - 64 mm (BSI)             |                 | green       | 11.65   | 10                  | 10.60         | 0600-3004 N4 |
| ⑳ | 2" coarse Tri-Sure - 64 mm (BSI)           |                 | brown       | 11.65   | 10                  | 10.60         | 0600-3002 N4 |
| ㉑ | 2" BSP - 64 mm (BSI)                       |                 | blue        | 11.65   | 10                  | 10.60         | 0600-3003 N4 |
| ㉒ | Adapter set, consisting of 1, 2, 14 and 16 |                 |             | 49.90   | 5                   | 46.15         | 0600-3010 N4 |

## Adapter set LaboPlast®



Adapter set consisting of:

- ▶ Thread adapter 3/4" - Hünersdorff
- ▶ Thread adapter 3/4" - Kautex
- ▶ Thread adapter 3/4" - cylindrical R 3/4" barrel thread
- ▶ Thread adapter 3/4" - conical R 3/4" barrel thread
- ▶ Hexagonal key for thread adapter



## Thread adapters LaboPlast® 3/4"



① Thread adapter 3/4" - Hünersdorff

② Thread adapter 3/4" - Kautex

③ Thread adapter 3/4" - cylindrical R 3/4" barrel thread

④ Thread adapter 3/4" - conical R 3/4" barrel thread

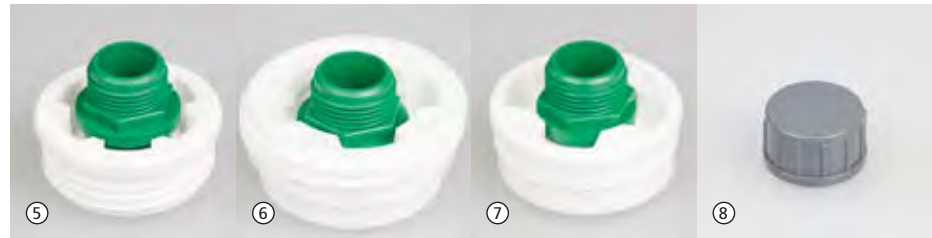

⑤ Thread adapter 3/4" - coarse thread, Tri-Sure 2"

⑥ Thread adapter 3/4" - coarse thread, Mauser 2"

⑦ Thread adapter 3/4" - fine thread 2"

⑧ Captive cap for 3/4"



⑨

Hexagonal key for thread adapter

StopCock spigots, ball valves and other accessories can be connected to most commercially available containers, with the LaboPlast® thread adapters. All adapters have a standard outer thread R 3/4".

### Thread adapter set LaboPlast®

| Price € | Quantity scale from | Scale price € | Item no.     |
|---------|---------------------|---------------|--------------|
| 17.05   | 10                  | 15.65         | 0600-0050 N4 |

|   | Thread, outflowing side              | Thread, in-flowing side | Colour      | Material | Price € | Quantity scale from | Scale price € | Item no.     |
|---|--------------------------------------|-------------------------|-------------|----------|---------|---------------------|---------------|--------------|
| ① | Hünersdorff                          | 3/4"                    | red         | PP       | 4.96    | 10                  | 4.44          | 0600-0010 N4 |
| ② | Kautex                               | 3/4"                    | blue        | PP       | 4.96    | 10                  | 4.44          | 0600-0020 N4 |
| ③ | cylindrical R 3/4" thread connection | 3/4"                    | black       | PP       | 4.96    | 10                  | 4.44          | 0600-0150 N4 |
| ④ | conical R 3/4" thread connection     | 3/4"                    | green       | PP       | 4.96    | 10                  | 4.44          | 0600-0030 N4 |
| ⑤ | coarse thread, Tri-Sure 2"           | 3/4"                    | green/white | PP/PE    | 11.75   | 10                  | 10.80         | 0600-0094 N4 |
| ⑥ | coarse thread, Mauser 2"             | 3/4"                    | green/white | PP/PE    | 11.75   | 10                  | 10.80         | 0600-0120 N4 |
| ⑦ | fine thread 2"                       | 3/4"                    | green/white | PP/PE    | 11.75   | 10                  | 10.80         | 0600-0190 N4 |
| ⑧ | Captive cap for 3/4"                 |                         | gray        | PVC      | 4.84    | 10                  | 4.34          | 0600-0090 N4 |
| ⑨ | Hexagonal key for thread adapter     |                         | blue        | PP       | 2.38    | 10                  | 2.14          | 0600-0001 N4 |

## Gas-tight barrel pump PP | odor-free liquid transfer

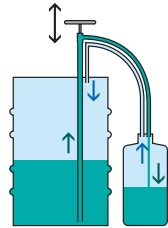

Liquid is pumped in the closed system (green). Vapours are directed back through the gas displacement line (blue)

- ▶ Medium-contacting parts PP and PVC soft (hose)
- ▶ Steplessly extendable telescopic tube
- ▶ For barrel depths of 40 - 67 cm
- ▶ Two adapters for original containers

The gas-tight barrel pump enables odour-free transfer. During transfer with normal pumps, it is impossible to prevent vapours escaping into the atmosphere. The gas-shuttle method avoids this. Any vapours produced are returned from the container which is to be filled to the original container via the gas-shuttle pipe. The gas pipe and the liquid pipe are additionally provided with stopcocks. Gas-tight pumps are used for substances that have a strong smell such as ammonia.

### Gas-tight barrel pump PP

| Model   | Pump capacity ml per stroke | Price € | Item no.     |
|---|-----------------------------|---------|--------------|
| ① with universal adapter 30-70 mm Ø               | 200                         | 197.05  | 5610-1030 N4 |
| ② with 2 screw joint adapters 3/4" with lock nuts | 200                         | 197.05  | 5610-1040 N4 |

## Gas-tight stainless steel pump

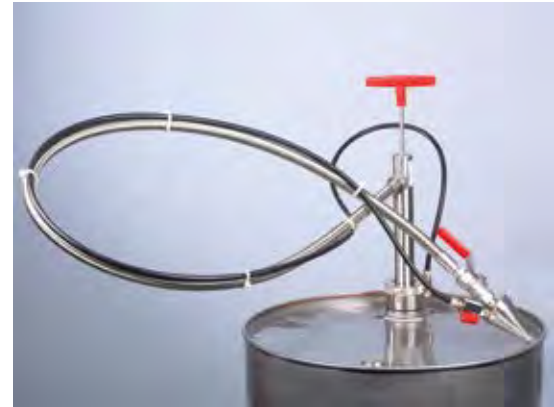

- Gas tight barrel pump with flexible discharge hose for filling off into large canisters and containers. Convenient transfer because the canister can stay on the floor. The connection cone is held onto the container.
- ▶ Parts in contact with media: Stainless steel (1.4301), PTFE, nickel-plated brass, PA that can conduct electricity
  - ▶ Incl. gas-tight barrel screw joints with 2" fine thread
  - ▶ For bottle openings from 16 - 49 mm
  - ▶ Immersion tube Ø 32 mm
  - ▶ The pump can be hermetically sealed with two ball valves

Pump has been developed in cooperation with Ludwig-Maximilians University, Munich.

### Gas-tight stainless steel barrel-pump - discharge hose/stopcock

| Immersion depth cm | Total length cm | Pump capacity ml per stroke | Price € | Quantity scale from | Scale price € | Item no.     |
|--------------------|-----------------|-----------------------------|---------|---------------------|---------------|--------------|
| 57                 | 69              | 350                         | 711.10  | 5                   | 650.60        | 5611-1090 N4 |
| 91                 | 103             | 560                         | 734.55  | 5                   | 672.90        | 5611-0090 N4 |



## Lever pump aluminium



Lever pump for petrochemical substances made of stable aluminium cast, valves and pistons are made of plastic (PA).

- ▶ Suitable for barrel threads M 64 x 4 or R2"
- ▶ With closure device
- ▶ Immersion tube length 84 cm
- ▶ Supplied with hose kit, hose length 1.5 m, electrically conductive, with outlet elbow and bend protection spring

### Lever pump aluminium

| Pump capacity approx. l/min | Pumping height water column m | Connector thread | Price € | Item no.     |
|-----------------------------|-------------------------------|------------------|---------|--------------|
| 25                          | 1                             | M64x4, R2"       | 160.55  | 5627-1000 N2 |

### Accessories

| Description     | Price € | Item no.     |
|-----------------|---------|--------------|
| Anti-static set | 46.45   | 5602-1000 N4 |

## Rotary piston pumps



Rotary piston pump made of cast iron



Barrel screw joint rotary piston pump

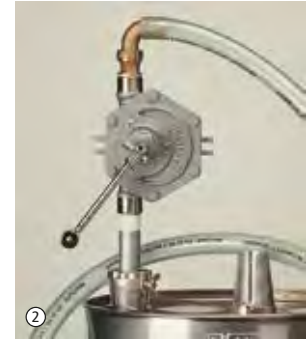

Rotary piston pump made of V2A

Many uses: Between hose connections, as a barrel pump with a rigid outlet elbow or a flexible discharge hose. It can pump in both directions by rotating backwards and forwards.

- ▶ Viscosity up to max. 150 cst ISO/11.5° Engler/40 SAE at + 20°C
- ▶ Hose kit consisting of 1.5 m PVC hose, connection fittings and filler pipe available as accessories
- ▶ With two-part immersion tube length 100 cm

### Rotary piston pump cast iron

| Pump capacity approx. l/min | Connector thread | Pumping height water column m | Material         | Price € | Item no.     |
|-----------------------------|------------------|-------------------------------|------------------|---------|--------------|
| ① 30                        | 3/4"             | 8                             | cast iron/bronze | 185.30  | 5626-1030 N2 |
| ① 40                        | 1"               | 7,5                           | cast iron/bronze | 234.75  | 5626-1040 N2 |

### Rotary piston pump stainless steel

| Pump capacity approx. l/min | Connector thread | Pumping height water column m | Material      | Price € | Item no.     |
|-----------------------------|------------------|-------------------------------|---------------|---------|--------------|
| ② 40                        | 1"               | 7                             | AISI 304/PTFE | 1190.05 | 5626-2040 N2 |

### Accessories

| Description   | Price € | Item no.     |
|---|---------|--------------|
| ③ Thread connection for rotary piston pump 3/4", 5626-1030            | 16.55   | 5626-0110 N2 |
| ④ Thread connection for rotary piston pump 1", 5626-1040 / -2040      | 18.55   | 5626-0121 N2 |
| Angled thread connection for rotary piston pump 3/4", 5626-1030       | 12.25   | 5626-0132 N2 |
| Angled thread connection for rotary piston pump 1", 5626-1040 / -2040 | 15.15   | 5626-0133 N2 |
| Discharge hose for rotary piston pump 3/4", 5626-1030                 | 23.55   | 5626-0031 N2 |
| Discharge hose for rotary piston pump 1", 5626-1040 / -2040           | 31.25   | 5626-0030 N2 |
| Discharge tube for rotary piston pump 3/4", 5626-1030                 | 13.90   | 5626-0012 N2 |

# Lever pump



### Lever pump with galvanised steel piston rod

The lever pump is made of polypropylene with a galvanised steel piston rod and FKM seals.

### Lever pump with stainless steel piston rod

The lever pump is made of polypropylene with a stainless steel piston rod made of V2A (1.4301) and FKM seals.

The required quantities can be taken from barrels without great effort with this manual lever pump. Ideal for occasional use.

Applications of the lever pump: water, lubricants, light oils, water-based chemicals and light acids and caustic solutions.

- ▶ With integrated barrel screw connection for 1 1/4" and 2" fine thread
- ▶ Pump capacity 350 ml per stroke
- ▶ Immersion depth steplessly variable from 65–90 cm

Attention! Make sure to pay attention to the "List of Chemical Resistance"!

| Lever pump with galvanised steel piston rod |         |           |    |  |
|---|---------|-----------|----|--|
| Colour                                      | Price € | Item no.  |    |  |
| blue  | 24.80   | 5613-0040 | N4 |  |

| Lever pump with stainless steel piston rod |         |           |    |  |
|--|---------|-----------|----|--|
| Colour                                     | Price € | Item no.  |    |  |
| yellow                                     | 35.90   | 5613-0041 | N4 |  |

## Compact lever pump





Compact, self-priming polyethylene lever pump, suitable for alkaline liquids and many acids. The telescope suction tube for lever pump is steplessly extendable to 914 mm, which means it can be used for barrels from 60 to 200 l.

- ▶ Pump capacity is about 300 ml per stroke
- ▶ With integrated barrel screw connection for 2" BSP thread

**!** Attention! Make sure to pay attention to the "List of Chemical Resistance"!

### Compact lever pump

|                    |         |           |   |
|--------------------|---------|-----------|---|
| Immersion depth cm | Price € | Item no.  |   |
| 91                 | 50.80   | 5613-0020 | N4  |

## Piston pump PP



The piston pump is made of polypropylene and polyethylene, for watery and petrochemical products. It represents value-for-money. The piston pump is attached to the container which is to be filled using a 2" - or 3/4" barrel thread. After mounting, the pump can still be rotated around its axis so that containers to be filled can be placed on the barrel lid.

- ▶ Pump capacity adjustable from 100, 250, 350 and 500 ml per stroke
- ▶ For containers with R2" and 3/4" inner thread
- ▶ Immersion tube length 84 cm

**!** Attention! Make sure to pay attention to the "List of Chemical Resistance"!

### Piston pump PP

|         |           |   |
|---------|-----------|---|
| Price € | Item no.  |   |
| 22.25   | 5613-0030 | N4  |

## AccuOne / EnergyOne | Flexible – reliable – convenient – with the hybrid system

The new approach to flexibility - One pump with maximum possibilities.

Bürkle barrel pumps AccuOne and EnergyOne with the unique hybrid system ensure fast, flexible and convenient filling whenever and wherever you want. The pumps are equipped with two different power supply systems:

AccuOne, driven by a high-performance rechargeable battery or EnergyOne, with a power cable for direct connection to the electrical network.

### The innovative new feature: The power supply units are interchangeable!

The rechargeable battery or the power supply unit are fitted with a clip lock and are removable. They can be exchanged quickly and easily. Thus AccuOne can also be operated with the power supply cable unit and EnergyOne can be operated with the rechargeable battery.

With a replacement rechargeable battery as an accessory, you never have to wait for charging. The drive can also be disconnected quickly and easily from the pump station with a clip lock. This makes it possible to use one drive for filling at several stationary pump stations.

AccuOne and EnergyOne are designed for applications in which even very small amounts of liquid can be added to small containers with narrow openings.

The touch panel features a foil keyboard sealed off against dust, dirt and water. The keyboard can be used to regulate the flow rate continuously and precisely from 0.4 l/min to 12 l/min.

In addition to the drainage elbow, a flexible drainage hose with nozzle is optionally available.

The light and powerful pumps are made of high-quality materials, PP, PTFE and Hastelloy C, to ensure outstanding chemical resistance. This also makes them suitable for dispensing acids and bases. Please make note of detailed information related to chemical resistance!

 Attention! Make sure to pay attention to the "List of Chemical Resistance"!

 Do not use in EX area!

- ▶ Unique hybrid system – rechargeable battery and power supply unit are interchangeable
- ▶ Drive unit can be easily disconnected
- ▶ TouchPanel for precise dosing
- ▶ Excellent residual draining and pumping capacity
- ▶ One drive for several pump stations
- ▶ Outstanding chemical resistance



Battery can be easily disconnected



Power supply unit can be easily disconnected



Drive unit can be easily disconnected



Touch panel



Power supply unit incl. connector



Charger for battery





## AccuOne barrel pump



More accessories on page 36

The barrel pump driven by rechargeable battery, AccuOne, features a unique new hybrid system with complete flexibility and independence from the electrical network. A powerful light rechargeable battery with the latest next generation lithium-ion technology, without memory effect, with auto-stop function before deep discharge.

- ▶ Lithium-ion rechargeable battery – latest generation
- ▶ Up to 600 litres of delivery volume per battery charge, replacement back-up battery available
- ▶ Optionally available with rechargeable battery or power supply unit (available as accessory)
- ▶ Consisting of pump station, drive, rechargeable battery, charger and fixed discharge elbow

| AccuOne barrel pump driven by rechargeable battery   |         |           |    |
|--|---------|-----------|----|
| Immersion depth cm   | Price € | Item no.  |    |
| 50   | 408.50  | 5900-1050 | N4 |
| 70   | 420.10  | 5900-1070 | N4 |
| 100  | 431.90  | 5900-1100 | N4 |
|  Accessories  |         |           |    |
| Description  | Price € | Item no.  |    |
| PP barrel screw joint, R 2", steel fine outer thread   | 26.10   | 5600-3130 | N4 |
| PP barrel screw joint, Mauser 2", coarse outer thread  | 32.60   | 5600-3170 | N4 |
| PP barrel screw joint, Tri-Sure, coarse outer thread   | 36.70   | 5600-3180 | N4 |



## EnergyOne barrel pump



More accessories on page 36

The barrel pump driven by power supply unit, EnergyOne, features a unique new hybrid system with complete flexibility and independence from battery charging.

- ▶ Power supply via 230 V power supply unit, international plug adapter included with delivery.
- ▶ Unlimited filling duration
- ▶ Optionally available with power supply unit or rechargeable battery (available as accessory)
- ▶ Consisting of pump station, drive, power supply unit incl. connector and fixed discharge elbow

| EnergyOne barrel pump driven by power supply unit   |         |           |    |
|---|---------|-----------|----|
| Immersion depth cm  | Price € | Item no.  |    |
| 50  | 345.25  | 5900-2050 | N4 |
| 70  | 357.05  | 5900-2070 | N4 |
| 100   | 368.70  | 5900-2100 | N4 |
|  Accessories   |         |           |    |
| Description   | Price € | Item no.  |    |
| PP barrel screw joint, R 2", steel fine outer thread  | 26.10   | 5600-3130 | N4 |
| PP barrel screw joint, Mauser 2", coarse outer thread   | 32.60   | 5600-3170 | N4 |
| PP barrel screw joint, Tri-Sure, coarse outer thread  | 36.70   | 5600-3180 | N4 |

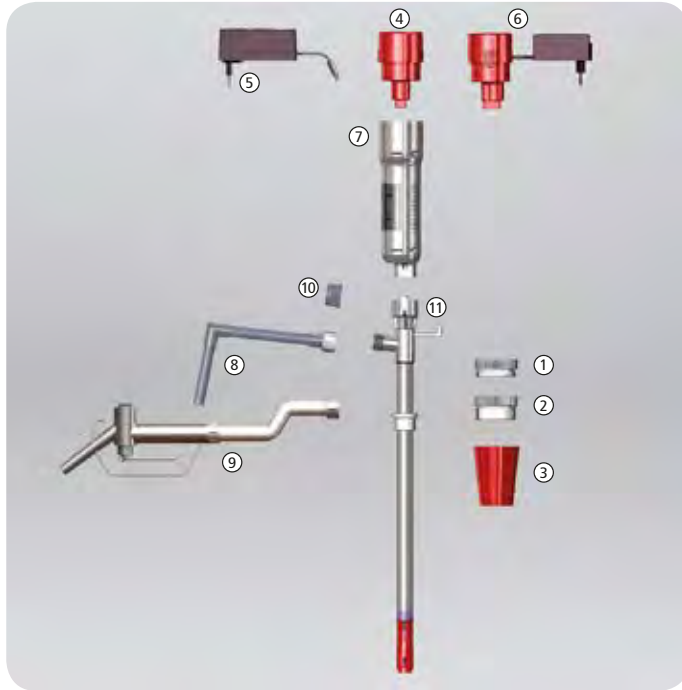

Light- and high-performance pump to transfer small quantities of watery media up to 300 mPas from canisters, barrels and narrow-necked containers from 32 mm opening diameter.

- ▶ PP
- ▶ Splash-water protected motor 230 V/200 W (IP44)
- ▶ Built-in safety key as on/off switch
- ▶ Seal-less pump mechanism for acids and alkalis
- ▶ Thread connection 1" with hose connector 3/4"
- ▶ Incl. 1.5 m PVC hose 3/4", PP nozzle and wall bracket

**!** Attention! Make sure to pay attention to the "List of Chemical Resistance"!

### Accessories

| Description   | Price € | Item no.     |
|---|---------|--------------|
| ① PP barrel screw joint, R 2", steel fine outer thread    | 26.10   | 5600-3130 N4 |
| ① PP barrel screw joint, Mauser 2", coarse outer thread   | 32.60   | 5600-3170 N4 |
| ① PP barrel screw joint, Tri-Sure, coarse outer thread    | 36.70   | 5600-3180 N4 |
| ② Container screw joint                                   | 32.25   | 5600-3140 N4 |
| ③ PVC barrel plug, dia. 40-70 mm (not for EX zone)        | 20.45   | 5600-3150 N4 |
| ④ Rechargeable battery without charger for Accu/EnergyOne | 103.20  | 5900-3010 N4 |
| ⑤ Charger for battery Accu/EnergyOne                      | 56.65   | 5900-3015 N4 |
| ⑥ Power supply unit incl. connectors for Accu/EnergyOne   | 116.30  | 5900-3020 N4 |
| ⑦ Drive without rechargeable battery/power supply unit    | 188.50  | 5900-3030 N4 |
| ⑧ Discharge tube  | 17.90   | 5900-3040 N4 |
| ⑨ Discharge hose 1.2 m, with nozzle (PVC, PP, V2A, FKM)   | 63.00   | 5900-3045 N4 |
| ⑩ Closing cap thread 3/4"                                 | 3.56    | 8535-0034 N3 |
| ⑪ Pump station Accu/EnergyOne, submersible length 50 cm   | 117.00  | 5900-3050 N4 |
| ⑪ Pump station Accu/EnergyOne, submersible length 70 cm   | 121.65  | 5900-3070 N4 |
| ⑪ Pump station Accu/EnergyOne, submersible length 100 cm  | 126.15  | 5900-3100 N4 |

### Laboratory pump mains operated

| Immersion depth cm | Pump capacity approx. l/min | Pumping height water column m | Tube Ø mm | Price € | Item no.     |
|--------------------|-----------------------------|-------------------------------|-----------|---------|--------------|
| 70                 | 75                          | 7                             | 32        | 740.75  | 5700-2200 N2 |
| 100                | 75                          | 7                             | 32        | 798.85  | 5700-4400 N2 |

### Accessories

| Description                    | Price € | Item no.     |
|--------------------------------|---------|--------------|
| Flow meter PP 1" (see page 40) | 557.50  | 5700-0111 N2 |

## Electric barrel pump Petro | for Diesel oil, class D/II fuel oil



Electric barrel pump for pumping diesel oil, Category EL fuel oil, undiluted radiator antifreeze and other liquids of Hazard Category AIII (VbF). Built-in siphon protection prevents leaks if the tube is faulty. Available for 230 V. Available with either standard filling nozzle or filling nozzle with automatic shut-off. Electronic volume readout with cumulative total and suitable for calibration (supplied uncalibrated), available as accessory.

- ▶ With manual suction pump
- ▶ VDE tested, motor with thermal protection switch
- ▶ Barrel thread M 64 x 4 and 2"
- ▶ Suction hose with filter 1.60 m length
- ▶ Pump hose made of Perbunan, 4 m length, with bend protection spring and pump nozzle

Not suitable for aqueous/diluted liquids!



Petro flow counter

### Electric barrel pump Petro

| Model     | Pump capacity approx. l/min | Price € | Item no.     |
|-----------|-----------------------------|---------|--------------|
| standard  | 40                          | 282.34  | 5780-0040 N2 |
| automatic | 40                          | 434.86  | 5780-0041 N2 |

### Accessories

| Description          | Price € | Item no.     |
|----------------------|---------|--------------|
| Volume readout Petro | 311.71  | 5780-0020 N2 |

## Drum pump for acids and alkalis



Barrel pump for weaker acids, such as hydrochloric acid, phosphoric acid, chromic acid, battery acid, citric acid, etc.

- ▶ Motor 230 V
- ▶ Pump tube PP, shaft Hastelloy C
- ▶ Thread connection 1 1/4" with hose connector 3/4"
- ▶ 2 m PVC fabric hose 3/4"
- ▶ PP pump nozzle
- ▶ PP barrel screw joint
- ▶ Pump height 19 mWS, pump capacity 85 l/min

**⚠ Attention!** Make sure to pay attention to the "List of Chemical Resistance"!

| Drum pump for acids and alkalis    |           |              |              |
|------------------------------------|-----------|--------------|--------------|
| Immersion depth cm                 | Tube Ø mm | Price €      | Item no.     |
| 100                                | 41        | 1287.90      | 5762-0100 N2 |
| 120                                | 41        | 1302.40      | 5762-0101 N2 |
| 📦 Accessories                      |           |              |              |
| Description                        | Price €   | Item no.     |              |
| Flow meter PP 1 1/4" (see page 40) | 550.65    | 5700-0121 N2 |              |

## Drum pump for concentrated acids/alkalis



Barrel pump for highly aggressive acids and alkalis, such as sulphuric acid, nitric acid, hydrofluoric acid, sodium hypochlorite etc.

- ▶ Motor 230 V
- ▶ PVDF pump tube
- ▶ Thread connection 1 1/4" with hose connector 3/4"
- ▶ 2 m special chemical hose 3/4"
- ▶ PVDF pump nozzle
- ▶ PP barrel screw joint
- ▶ Pump height 17 mWS, pump capacity 80 l/min

**⚠ Attention!** Make sure to pay attention to the "List of Chemical Resistance"!

| Drum pump for concentrated acids/alkalis |           |              |              |
|--|-----------|--------------|--------------|
| Immersion depth cm                       | Tube Ø mm | Price €      | Item no.     |
| 100                                      | 41        | 2423.70      | 5762-0200 N2 |
| 120                                      | 41        | 2545.25      | 5762-0201 N2 |
| 📦 Accessories                            |           |              |              |
| Description                              | Price €   | Item no.     |              |
| Flow meter PVDF 1 1/4" (see page 40)     | 785.25    | 5700-0141 N2 |              |



## Drum pump for mineral oils



Barrel pump for light viscous mineral oil products, such as diesel, fuel oil, hydraulic fluid, machinery and motor oil, etc.

- ▶ Motor 230 V
- ▶ Pump tube made of aluminium
- ▶ Hose connection Alu 1"
- ▶ 2 m PVC fabric hose 1"
- ▶ Hose clips 1"
- ▶ Alu pump nozzle, PP barrel screw joint
- ▶ Medium-contacting parts made of aluminium and V4A (1.4571)
- ▶ Delivery pump height 19 mWS, Pump capacity 85 l/min

**!** Attention! Make sure to pay attention to the "List of Chemical Resistance"!

### Drum pump for mineral oils



| Immersion depth cm | Tube Ø mm | Price € | Item no.     |
|--------------------|-----------|---------|--------------|
| 100                | 41        | 1402.50 | 5763-0100 N2 |

## Drum pump for solvents



Barrel pump for highly flammable hydrocarbons such as ethanol, benzene, butanol, isopropanol, kerosene, methanol, etc.

- ▶ Motor 230 V
- ▶ Pump tube made of stainless steel
- ▶ Voltage balancing cable
- ▶ Hose electrically-conductive
- ▶ 2 m solvent hose 3/4"
- ▶ Brass pump nozzle
- ▶ PP barrel screw joint
- ▶ Delivery pump height 14 mWS, pump capacity 95 l/min

**!** Attention! Make sure to pay attention to the "List of Chemical Resistance"!

### Drum pump for solvents



| Immersion depth cm | Tube Ø mm | Price € | Item no.     |
|--------------------|-----------|---------|--------------|
| 100                | 41        | 2777.75 | 5763-0301 N2 |

## Flow meters



Compact electronic flow counter for electrical barrel and container pumps. For thin fluid media.

- ▶ Measuring according to the turbine wheel principle
- ▶ Counter can be calibrated depending on the medium
- ▶ Different versions for many different applications
- ▶ Automatic switch-on when flow is recognised
- ▶ Measuring accuracy  $\pm 1\%$ , easy recalibration
- ▶ Long-life lithium battery
- ▶ For use up to max. 4 bar (20°C)
- ▶ Range of viscosity 0,8 - 40 mPas
- ▶ Temperature -10 °C up to +50 °C

| Flow meter              |  |                       |                  |         |           |    |  |
|-------------------------|--|-----------------------|------------------|---------|-----------|----|--|
| Material                | Model  | Measuring range l/min | Connector thread | Price € | Item no.  |    |  |
| PP, Hastelloy C4, FKM   | for fuel oil, diesel, hydrochloric acid, sod. hydroxide, etc.                          | 5 – 90                | G 1 1/4"         | 550.65  | 5700-0121 | N2 |  |
| PP, Hastelloy C4, FKM   | for fuel oil, diesel, hydrochloric acid, sod. hydroxide, etc.                          | 5 – 90                | G 1"             | 557.50  | 5700-0111 | N2 |  |
| PVDF, Hastelloy C4, FKM | for highly aggressive liquids like chlorine bleaches, nitric acid, sulfuric acid, etc. | 5 – 90                | G 1 1/4"         | 785.25  | 5700-0141 | N2 |  |

## Oil-free double-diaphragm pump



Pneumatic double-diaphragm pump to pump viscous, corrosive, abrasive and flammable liquids. Pump model 1/4". The pump is available in the materials polypropylene, PVDF and nylon. The membranes, balls and valve seats are available in Geolast, PTFE and Santoprene. Solids up to 1.6 mm Ø can be transported.

- ▶ Max. pump capacity 16 l/min
- ▶ Suction height dry 6 m
- ▶ Self-priming
- ▶ Operating compressed air min. 1.4 bar, max. 6.8 bar
- ▶ Max. temperature 66°C
- ▶ Inlet side/outlet side 1/4" inner thread

| Oil-free double-diaphragm pump                       |                                   |         |           |    |  |
|--|-----------------------------------|---------|-----------|----|--|
| Model  | Material                          | Price € | Item no.  |    |  |
| for water-based liquids, lubricants, mineral oil     | housing PP, diaphragm. Geolast    | 404.35  | 5765-0001 | N2 |  |
| for corrosive liquids, inorganic acids and alkalis   | housing PP, diaphragm. PTFE       | 588.38  | 5765-0002 | N2 |  |
| for water-based liquids, sodium hydroxide solution   | housing PP, diaphragm. Santoprene | 434.03  | 5765-0003 | N2 |  |
| for strong acids and alkalis, increased temperatures | housing PVDF, diaphragm. PTFE     | 708.40  | 5765-0004 | N2 |  |

## Magnetic centrifugal pumps



The magnetic centrifugal pumps are suitable for transferring acids, alkalis, alkaline and electroplating baths, photography chemicals as well radioactive, sterile and highly corrosive liquids. The drive, via contact-free magnetic force transfer, requires no dynamic shaft seals and this makes a hermetically sealed pump housing possible, which means that it cannot leak.

- ▶ Seal-less
- ▶ Surrounding temperature max. 45 °C
- ▶ Operating temperature max. 60 °C
- ▶ Viscosity max. 20 mPas

Magnetic centrifugal pump 15 Watts, motor 230 V, material PP (reinforced with fibre glass), stainless steel (shaft), Rulon (bearing), FKM (seal).

- ▶ Pump capacity 1 to 12 l/min, delivery height up to 2 m
- ▶ Without thread, hose nozzle 14 mm

Magnetic centrifugal pump 29 Watts, motor 230 V, material PP (fibre glass reinforced), stainless steel, Rulon (bearing), FKM (seal), ceramics (shaft).

- ▶ Pump capacity 1 to 24 l/min, delivery pump height up to 3 m
- ▶ Suction connection / pressure connection G 3/4" outer thread (BSP)

### Magnetic centrifugal pump 15 Watt

| Model   | Price € | Item no.     |
|---|---------|--------------|
| ① 15 Watt, no thread connection, with tubing nozzle | 382.05  | 5766-0001 N2 |
| ② 29 Watt, with R 3/4" outer thread                 | 412.90  | 5766-0002 N2 |



## AirJet Mini vacuum pump/compressor



The AirJet Mini single-head membrane vacuum pump is suitable for a variety of applications in the laboratory and industry. The dry running membrane vacuum pump is able to pump, compact and evacuate 100% oil-free, which means it does not distort results or add impurities, and can also be used as a compressor. The AirJet Mini is used to pump and evacuate air and neutral or slightly aggressive or corrosive gases and vapours.

- ▶ Weight 1.9 kg, dimensions LxWxH 164/90/141 mm
- ▶ Hose connection ID 4 mm
- ▶ Maintenance-free, environmentally friendly
- ▶ High level of gas tightness
- ▶ Very quiet with low vibrations

**⚠ Attention!** Make sure to pay attention to the "List of Chemical Resistance"!



### ① AirJet Mini membrane vacuum pump/compressor

| Model                 | Pump capacity approx. l/min | Vacuum mbar | Pressure max. bar | Price € | Item no.     |
|-----------------------|-----------------------------|-------------|-------------------|---------|--------------|
| Membrane made of EPDM | 6                           | 100         | 2,4               | 334.70  | 5625-2000 N2 |
| Membrane made of PTFE | 5,5                         | 160         | 2,5               | 404.30  | 5625-2001 N2 |

### 🧰 Accessories

| Description                        | Price € | Item no.     |
|------------------------------------|---------|--------------|
| ② AirJet Mini fine regulation head | 72.95   | 5625-2002 N2 |
| ③ AirJet Mini sound absorber       | 12.35   | 5625-2003 N2 |

## Siphon with stopcock | for occasional drawing off of liquids





Device for easy operation to quickly fill off watery liquids from containers higher up to containers lower down.

Works according to the siphoning principle: Liquid needs only to be primed once, therefore especially handy for complete emptying of a container.

- ▶ LDPE/PVC
- ▶ Pump capacity 9l/min
- ▶ With robust ball valve made of PP
- ▶ Good view of medium due to transparent hoses
- ▶ Bend protection for the hose with suspension eyelet
- ▶ Cost-effective filling unit if drawing-off does not need to take place regularly

 Offered also as rigid immersion tube upon request.

### Siphon with stopcock

| Material        | Immer-<br>sion<br>depth<br>cm | Hose<br>inner dia.<br>mm | Pump<br>capacity<br>approx. l/<br>min | Price € | Quan-<br>tity scale<br>from | Scale<br>price € | Item no.  |    |
|-----------------|-------------------------------|--------------------------|---------------------------------------|---------|-----------------------------|------------------|-----------|---|
| LDPE/<br>PVC/PP | 100                           | 15                       | 9                                     | 44.45   | 10                          | 40.35            | 5605-1000 | N4  |

## Viscosity of liquids

### The right pump for each liquid

Pumps are used in widely different fields of application. Bürkle offers a large number of different versions. However, when choosing a suitable pump several criteria must be considered. The most important are the viscosity, structure and density of the liquid.

How the liquid behaves under the influence of external influences, e.g. variations in temperature and pressure, is also important.

We would be pleased to help you make certain that you choose the correct pump for your application.

### Viscosity – what actually is viscosity?

The viscosity characterizes the flow behavior of a liquid. High-viscosity liquids are thick, low-viscosity liquids thin. This viscosity results from intermolecular forces; these are also known as the internal friction. This internal friction decreases as the temperature increases and increases as the temperature decreases.

The dynamic viscosity is given in Pas, for low-viscosity liquids in mPas. It is defined as the force in newtons that is necessary to displace a liquid layer of  $1 \text{ m}^2$  and  $1 \text{ m}$  height along a boundary parallel to a second layer at a speed of  $1 \text{ m}\cdot\text{s}^{-1}$ .

### Viscosity using motor oil as an example

Everyone has heard of the viscosity terms for motor oil. This classification is based on the flow behavior of the motor oil as a function of the temperature. In Winter low-viscosity oils are required. In Summer the oil becomes hotter, but it must still remain sufficiently thick.

For example: SAE 5W-40. The first number defines the viscosity at  $0^\circ\text{F}$  ( $-18^\circ\text{C}$ ), the second for a temperature of  $210^\circ\text{F}$  ( $99^\circ\text{C}$ ). An oil with the classification 5W (W=Winter) is therefore thinner than a 15W motor oil under cold conditions.



### Typical viscosity values in mPas at $20^\circ\text{C}$

|             |       |              |       |                 |          |
|-------------|-------|--------------|-------|-----------------|----------|
| Kerosine    | 0,65  | Coffee cream | ~ 10  | Hydraulic oil   | ~ 120    |
| Water       | 1,0   | Glycol       | 40    | Motor oil 15W40 | 390      |
| Grape juice | 2 – 5 | Olive oil    | ~ 100 | Honey           | ~ 10 000 |

# StopCocks | completely water-tight, easily operated

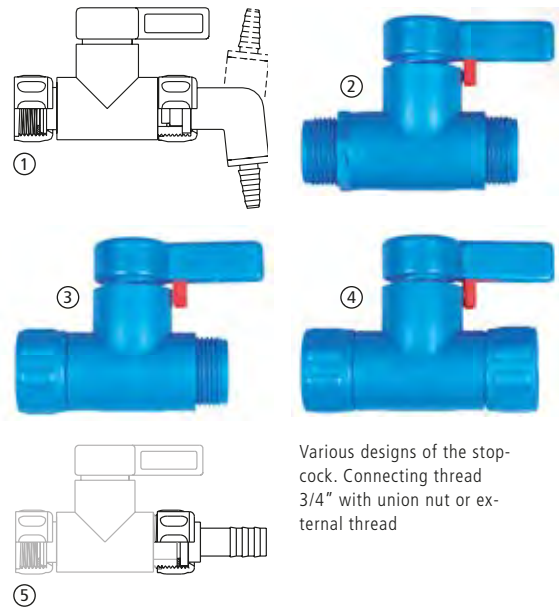
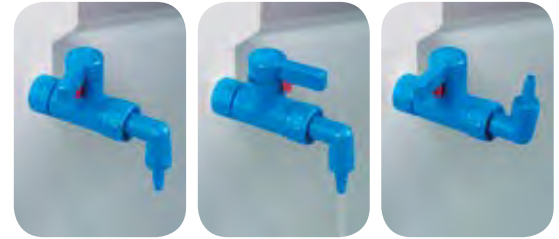

The StopCock discharge cocks fits all containers with R 3/4" connection threads. Thread adapters facilitate connection of cocks to nearly all containers.

- ▶ Tight-closing for complete seal
- ▶ Especially effortless
- ▶ With connecting cap nut, guaranteed vertical position of the cock
- ▶ Pressure-resistant up to 2 bar at 20°C (without discharge bracket and grommet)

- ▶ With discharge angle and rotatable spout preventing drips
- ▶ With tapered spout for bottles with narrow openings with a diameter from 6 to 8 mm.
- ▶ Media-contacting parts PP, PE and PTFE

**!** Not suitable for crystallising substances!

Various designs of the stop-cock. Connecting thread 3/4" with union nut or external thread

## StopCock angled



| Thread, inflowing side      | Thread, outflowing side | Price € | Quantity scale from | Scale price € | Item no.     |
|-----------------------------|-------------------------|---------|---------------------|---------------|--------------|
| ① 3/4" inner thread cap nut | spout/nozzle            | 20.30   | 10                  | 18.15         | 0525-1000 N4 |

## StopCock straight-through



| Thread, inflowing side      | Thread, outflowing side   | Price € | Quantity scale from | Scale price € | Item no.     |
|-----------------------------|---------------------------|---------|---------------------|---------------|--------------|
| ② 3/4" outer thread         | 3/4" outer thread         | 22.45   | 10                  | 20.35         | 0525-3000 N4 |
| ③ 3/4" inner thread cap nut | 3/4" outer thread         | 20.15   | 10                  | 18.20         | 0525-5000 N4 |
| ④ 3/4" inner thread cap nut | 3/4" inner thread cap nut | 23.90   | 10                  | 21.75         | 0525-7000 N4 |

## Accessories

| Description                 | Price € | Item no.     |
|-----------------------------|---------|--------------|
| ⑤ Hose nozzle StopCock 4 mm | 13.15   | 0525-1304 N4 |
| Hose nozzle StopCock 6 mm   | 13.15   | 0525-1306 N4 |
| Hose nozzle StopCock 8 mm   | 13.15   | 0525-1308 N4 |
| Hose nozzle StopCock 10 mm  | 13.15   | 0525-1310 N4 |
| Hose nozzle StopCock 12 mm  | 13.15   | 0525-1312 N4 |
| Hose nozzle StopCock 16 mm  | 13.15   | 0525-1316 N4 |
| Discharge angle             | 8.05    | 0525-1400 N4 |

## Compact spigot



The spigot Compact for canisters and barrels captivates everyone through its compact build, which makes the valve on the canister ideal for use in refrigerators and on racks, etc. The short discharge does not protrude out over the lower edge of the container, which makes the valve a perfect choice even when space is very limited.

The discharge's specially optimised design creates an even stream of liquid with no splashing or spattering. The spigot features easy motion and a tight seal. It is screwed on with a connecting cap nut. This guarantees a vertical position of the valve and makes it possible to adjust the valve later on.

The Compact spigot fits all containers with R 3/4" connecting threads.

PP, PE and PTFE are materials that offer outstanding chemical resistance to acids and alkalis.

The Compact spigot is the ideal addition to Flachmann jerrycans – for perfect storage and filling when space is at a premium!

- ▶ Space-saving design
- ▶ Optimised discharge for even flow
- ▶ With connecting union nut for vertical position of the stop cock
- ▶ Tight-closing for complete seal

### Compact spigot

| Thread, inflowing side    | Price € | Quantity scale from | Scale price € | Item no.     |
|---------------------------|---------|---------------------|---------------|--------------|
| 3/4" inner thread cap nut | 13.25   | 10                  | 11.00         | 0530-1000 N4 |



## Compact jerrycan & StopCock set



LaboPlast

The Compact jerrycan & StopCock set consists of the compact jerrycan Flachmann with glands (0435-2050) and the spigot StopCock (0525-1000).

| Compact jerrycan & StopCock set |                     |               |              |
|---------------------------------|---------------------|---------------|--------------|
| Price €                         | Quantity scale from | Scale price € | Item no.     |
| 46.50                           | 10                  | 41.75         | 0435-0001 N4 |

## Compact jerrycan & Compact stop cock set



The Compact stop cock is the ideal addition to Flachmann jerrycans – for perfect storage and filling when space is at a premium! The space-saving set consists of the compact Flachmann jerrycan with glands (0435-2050) and the spigot Compact (0530-1000).

LaboPlast

| Compact jerrycan & Compact stop cock set |                     |               |              |
|--|---------------------|---------------|--------------|
| Price €                                  | Quantity scale from | Scale price € | Item no.     |
| 38.50                                    | 10                  | 33.70         | 0435-3000 N4 |



# StopCock PA, electroconductive



Assessment of Ignition Risk, usable in:  
 ▶ Zones 0 and 1  
 ▶ Explosion groups II A, II B  
 DEKRA EXAM GmbH  
**DEKRA**  
 tested  
 Identification No. 0158

Commercially available spigots made of the materials polyethylene or polypropylene cannot be used for solvents. The spigot StopCock PA is made of electrically conductive polyamide and therefore perfectly suitable for solvents.

StopCock PA fits onto 3/4" outer threads and with the supplied adapter onto 3/4" inner threads and therefore onto nearly all commercially available canisters and barrels where the discharge thread is at the bottom.

- ▶ With discharge angle and rotatable spout preventing drips
- ▶ With tapered spout for bottles with narrow openings with a diameter from 6 to 8 mm.
- ▶ Media-contacting parts PA conductive to electricity and PTFE
- ▶ Supplied with PA adapter conductive to electricity for 3/4" inner thread

## StopCock PA, electroconductive

|   |   |                  |                           |                        |                       |    |
|---|---|------------------|---------------------------|------------------------|-----------------------|----|
| Thread, inflowing side<br>3/4" inner thread cap nut | Thread, outflowing side<br>spout/nozzle | Price €<br>22.45 | Quantity scale from<br>10 | Scale price €<br>20.30 | Item no.<br>0525-1100 | N4 |
|---|---|------------------|---------------------------|------------------------|-----------------------|----|

## Ball valve PP



Ball valve PP fits all containers with R 3/4" connection thread. It can be attached to nearly all containers with thread adapters. Robust industrial quality, large flow.

- ▶ Suitable for crystallising media
- ▶ Max. 4 bar pressure at 20°C
- ▶ With connecting cap nut, guaranteed vertical position of the valve
- ▶ Incl. discharge angle
- ▶ Hose nozzle 16 mm Ø
- ▶ Nominal width 12 mm Ø

### Ball valve PP

| Price € | Quantity scale from | Scale price € | Item no.     |
|---------|---------------------|---------------|--------------|
| 51.80   | 5                   | 47.50         | 0500-0100 N4 |

### Accessories

| Description       | Price € | Item no.     |
|-------------------|---------|--------------|
| Sealing tape PTFE | 1.55    | 0006-4514 N3 |

## Ball valves PP for barrels



Ball valves for barrels made of PP for barrels with thread connections.

- ▶ Suitable for solidifying media
- ▶ Max. 4 bar pressure at 20°C
- ▶ Individually adaptable, through various accessories

### Ball valves PP for barrels

| Thread, inflowing side | Thread, outflowing side | Nominal width mm | Price € | Quantity scale from | Scale price € | Item no.     |
|------------------------|-------------------------|------------------|---------|---------------------|---------------|--------------|
| 1/2" outer             | 1/2" inner              | 15               | 40.35   | 10                  | 36.60         | 0500-0112 N4 |
| 3/4" outer             | 3/4" inner              | 20               | 46.55   | 10                  | 41.95         | 0500-0134 N4 |
| 1" inner               | 1" inner                | 25               | 50.05   | 5                   | 45.20         | 0500-8001 N3 |
| 1/2" inner             | 1/2" inner              | 15               | 36.00   | 5                   | 32.30         | 0500-8002 N3 |
| 3/4" inner             | 3/4" inner              | 20               | 41.10   | 5                   | 36.95         | 0500-8003 N3 |

### Accessories

| Description   | Price € | Item no.     |
|---|---------|--------------|
| Tube nozzles, fixed, straight 1/2" outer                            | 1.13    | 8545-0012 N3 |
| Tube nozzles, fixed, straight 3/4" outer                            | 1.29    | 8545-0034 N3 |
| Tube nozzles, fixed, straight 1" outer                              | 1.58    | 8545-0100 N3 |
| Tube bend, fixed, 1/2" outer  | 1.92    | 8547-0012 N3 |
| Tube bend, fixed, 3/4" outer  | 1.97    | 8547-0034 N3 |
| Tube bend, fixed, 1" outer  | 2.80    | 8547-0100 N3 |
| Adapter for ball valve, Coarse thread Tri-Sure 2" outer, 3/4" inner | 1.85    | 0600-0140 N3 |
| Adapter for ball valve, Fine thread 2" outer, 3/4" inner            | 6.75    | 0600-0180 N3 |
| Sealing tape PTFE   | 1.55    | 0006-4514 N3 |

## Ball valve PP, food



Ball valve made of PP with outer / inner thread, fibre-glass reinforced, ball made of PP, handle with O-ring made of food-safe NBR and seal made of HDPE.

- ▶ Max. operating pressure 10 bar (at +20°C)
- ▶ Max. operating temperature 100°C
- ▶ Suitable for food

Hose angle bracket, 90°, with cap nut, inner thread and reducing nozzle.



## Spigot "Air"



No additional ventilation opening required, PE, transparent, 3/4" thread connection outside.

- ▶ Self-venting
- ▶ NW 13 mm
- ▶ Seal made of natural rubber

### Ball valve PP, food

| Thread, inflowing side | Thread, outflowing side | Nominal width mm | Price € | Quantity scale from | Scale price € | Item no.     |
|------------------------|-------------------------|------------------|---------|---------------------|---------------|--------------|
| 1/2" inner             | M29x1,75 outer          | 15               | 14.20   | 10                  | 12.90         | 0500-8102 N3 |
| 3/4" inner             | M36x3 outer             | 20               | 17.00   | 10                  | 15.35         | 0500-8103 N3 |
| 1" inner               | M42x3 outer             | 25               | 20.45   | 10                  | 18.35         | 0500-8101 N3 |
| 1/2" outer             | M29x1,75 outer          | 15               | 15.80   | 10                  | 14.20         | 0500-8202 N3 |
| 3/4" outer             | M36x3 outer             | 20               | 18.45   | 10                  | 16.65         | 0500-8203 N3 |
| 1" outer               | M42x3 outer             | 25               | 22.40   | 10                  | 20.15         | 0500-8201 N3 |

### Accessories

| Description                                 | Price € | Item no.     |
|---|---------|--------------|
| Container connection, white 1/2" outer      | 8.15    | 8533-0012 N3 |
| Container connection, white 3/4" outer      | 9.45    | 8533-0034 N3 |
| Container connection, white 1" outer        | 9.95    | 8533-0100 N3 |
| Tube bend with cap nut, thread M29x1,75     | 3.38    | 8548-0020 N3 |
| Tube bend with cap nut, thread M36x3        | 3.71    | 8548-0025 N3 |
| Tube bend with cap nut, white, thread M42x3 | 4.87    | 8548-0030 N3 |
| Sealing tape PTFE                           | 1.55    | 0006-4514 N3 |

### Spigot "Air"

| Price € | Quantity scale from | Scale price € | Item no.     |
|---------|---------------------|---------------|--------------|
| 6.35    | 25                  | 5.70          | 0533-0010 N3 |

## Stainless steel spigot



Very sturdy and robust spigot made of stainless steel V2A (1.4301). The outlet of the spigot turns 360° so it can be adjusted to any required position. With a practical suspension device for filling container and eyelet for shutting off the spigot.

- ▶ Seals PTFE, FKM
- ▶ Self-closing
- ▶ Thread connection 3/4"
- ▶ Lockable
- ▶ NW 10 mm



### Stainless steel spigot

Price €  
109.00

Item no.  
0535-0020 N4



## Spigot "Brass"



Barrel tap for petrochemical liquids, closed independently when not used (increased safety), thread connection 3/4" on the outside.

- ▶ Seals NBR
- ▶ Self-closing
- ▶ NW 10 mm

### Spigot "Brass"

Price €

23.90

Quantity scale  
from

10

Scale price €

20.40

Item no.

0535-0010 N4



## Spigot Jumbo, with tap



Spigot with tap for R2" barrel thread, 50 mm flow, for viscous media such as lacquers, glue, shampoo.

- ▶ Cost-effective tap
- ▶ PE, brown
- ▶ Seal made of EPT

## Barrel valve

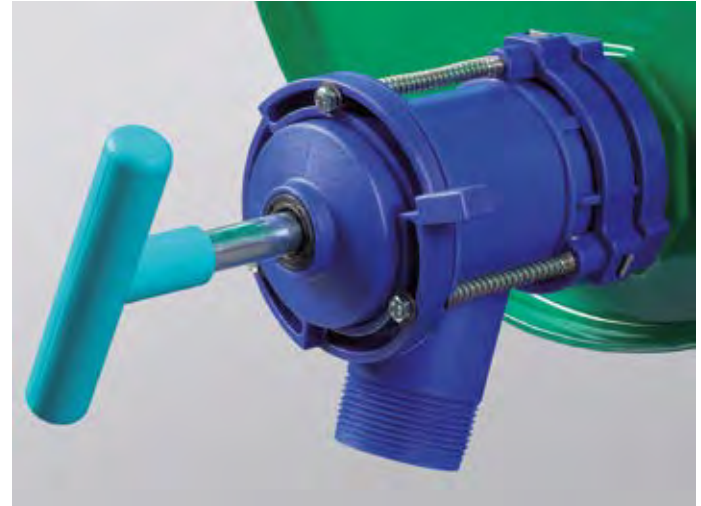

The barrel valve enables quick and clean emptying even with highly viscous liquids.

It is suitable for metal barrel with 2" BSP TriSure metal barrel screw joint.

The barrel valve enables opening the barrel closure as well as emptying and reclosing it even with lying, full barrels without having to move them.

### Spigot Jumbo, with tap

| Price € | Quantity scale from | Scale price € | Item no.  |    |
|---------|---------------------|---------------|-----------|----|
| 28.80   | 10                  | 28.15         | 0534-0020 | N4 |



### Barrel valve

| Price € | Item no.  |    |
|---------|-----------|----|
| 90.80   | 0536-0010 | N4 |



## IBC discharge valves

The IBC discharge valve is a sturdy, high-quality ball valve with a hose connection and connection adapter including seal, for standard thread S 60x6 external or 1" external, designed to fit all commonly used European IBC containers.

With the appropriate thread, the discharge valve can also be screwed directly onto the original discharge valve that is already on the IBC tank if the original valve is leaking or faulty. In this way the IBC discharge valve ensures fast and reliable residual emptying of the container with good dosing.

The discharge valve is an indispensable accessory to ensure a professional connection of the hose or for filling from your IBC container.

- ▶ 1" flow
- ▶ Suitable for connection threads S 60x6 external or 1" external
- ▶ Discharge valve and sealing cap PP fibreglass-reinforced, ball and adapter PP
- ▶ Max. operating pressure 10 bar (at +20°C)
- ▶ Max. operating temperature 80°C

- ① IBC discharge valve with 90° hose nozzle and sealing cap. The hose can also be closed with the enclosed sealing cap. Hose nozzle external PA Ø 30 mm, suitable for flexible hoses.
- ② IBC discharge valve with innovative hose screw connection The hose screw connection allows you to attach a wide range of hoses quickly, easily and reliably. No additional hose clamp is needed. Hose fitting PP/POM, external Ø 25 mm.

### ① IBC discharge valve with angle discharge

| Price € | Quantity scale from | Scale price € | Item no.     |
|---------|---------------------|---------------|--------------|
| 58.80   | 5                   | 54.05         | 0534-0002 N3 |



### ② IBC discharge valve with hose screw connection

| Price € | Quantity scale from | Scale price € | Item no.     |
|---------|---------------------|---------------|--------------|
| 58.80   | 5                   | 54.05         | 0534-0001 N3 |



## Wall-mounted dosing machine | precise dosing



Wall mounted dosing machines for simple, clean and precise dosing of resins, lacquers, peroxides, epoxies and many other pumpable materials - without sticking and contaminating. For fixed use in the work place.

### Use

1. Push the pump lever upwards. Read the dosage amount from the graduation on the glass cylinder.
2. Push the pump lever downwards. The liquid is pumped via the spigot directly into the container which is to be filled.

- ▶ Materials: Glass, PTFE, PE and stainless steel
- ▶ Easy cleaning
- ▶ Wall mounting prepared
- ▶ PE suction hose

### Wall-mounted dosing machine

| Dosing volume ml | Suction hose dia. mm | Division ml | Price € | Item no.     |
|------------------|----------------------|-------------|---------|--------------|
| 100              | 10                   | 1           | 699.58  | 5912-0100 N2 |
| 250              | 22                   | 5           | 1112.04 | 5912-0250 N2 |
| 500              | 29                   | 5           | 1368.00 | 5912-0500 N2 |



## LiquoFill filler for fluids



- ▶ Metering accuracy +/- 0.5 %
- ▶ 300-800 fillings per hour
- ▶ Self-feeding

### Accessories:

- ▶ Height-adjustable filling table made of stainless steel for positioning the container
- ▶ Nozzles with/without sieve, different diameters
- ▶ Diaphragm valves (for viscous products) and drip preventer (for products with low surface tension), only possible in pneumatic and semi-automatic drive

The LiquoFill fillers were specially developed for exact metering and filling of fluids of all types. LiquoFill is handy especially in small series, as the purchase of a stationary filling station designed in large series is often not profitable.

The metering and filling devices are used in production sites and laboratories for cosmetic, pharmaceutical and chemical products, paints as well as in the food and beverage industry. LiquoFill is ready to operate, simple to handle and easy to clean. The fillers can be mounted on the table using a fastener or screwed directly on to the table; they are portable and therefore usable at different places.

The fill quantity can be calibrated precisely and continuously using an adjusting nut, without any tools and can be read at a display. The adaptable hand lever facilitates use by both right- and left-handed individuals.

Parts in contact with the medium are made of stainless steel V4A (1.4404/1.4571), springs V2A (1.4310), PTFE and FCR (Fluorocarbon rubber). Housing made of aluminum, protection hoods made of stainless steel.

Different filling nozzles (Ø4/3 mm - Ø16/14 mm, with/without sieve) facilitate individual filling of diverse containers such as bottles, tubes, nozzles, crucibles or glasses.



When ordering, please state the material to be filled. We will test the chemical resistance. Please always indicate the desired size when ordering filling tubes.



## LiquoFill filler for fluids

### LiquoFill filler, manual mode of operation

Volumetric piston meter with manual drive. The fillers with manual operation can also be retrofitted with the pneumatic drive. Housing dimensions: LxWxH 690 x 150 x 350 mm.



#### LiquoFill filler, manual mode of operation

| Dosing volume ml | Filling nozzle dia. mm | Price € | Item no.     |
|------------------|------------------------|---------|--------------|
| 8 - 80           | 6/4                    | 3165.20 | 5913-0020 NO |
| 20 - 210         | 8/6                    | 3363.05 | 5913-0200 NO |
| 50 - 500         | 10/8                   | 3560.80 | 5913-0500 NO |

#### Accessories

| Description                             | Price € | Item no.     |
|---|---------|--------------|
| Height-adjustable filler                | 544.20  | 5913-0001 NO |
| LiquoFill filling funnel, approx. 10l   | 1266.20 | 5913-0002 NO |
| LiquoFill exchange kit, 8 - 80 ml       | 791.40  | 5913-0003 NO |
| LiquoFill exchange kit, 20 - 210 ml     | 811.30  | 5913-0004 NO |
| LiquoFill exchange kit, 50 - 500 ml     | 939.85  | 5913-0005 NO |
| LiquoFill seal kit for 5913-0020, -2020 | 182.15  | 5913-0006 NO |
| LiquoFill seal kit for 5913-0200, -2200 | 261.20  | 5913-0007 NO |
| LiquoFill seal kit for 5913-0500, -2500 | 324.60  | 5913-0008 NO |

### LiquoFill filler, pneumatic mode of operation

Volumetric piston meter with pneumatic drive, with start contact via foot-operated switch. For the pneumatic devices, compressed-air supply of 4 - 6 bar is required. Housing dimensions: LxWxH 1200 x 150 x 400 mm.



#### LiquoFill filler, pneumatic mode of operation

| Dosing volume ml | Filling nozzle dia. mm | Price € | Item no.     |
|------------------|------------------------|---------|--------------|
| 8 - 80           | 6/4                    | 4648.75 | 5913-2020 NO |
| 20 - 210         | 8/6                    | 5044.40 | 5913-2200 NO |
| 50 - 500         | 10/8                   | 5242.30 | 5913-2500 NO |

#### Accessories

| Description                             | Price € | Item no.     |
|---|---------|--------------|
| Height-adjustable filler                | 544.20  | 5913-0001 NO |
| LiquoFill filling funnel, approx. 10l   | 1266.20 | 5913-0002 NO |
| LiquoFill exchange kit, 8 - 80 ml       | 791.40  | 5913-0003 NO |
| LiquoFill exchange kit, 20 - 210 ml     | 811.30  | 5913-0004 NO |
| LiquoFill exchange kit, 50 - 500 ml     | 939.85  | 5913-0005 NO |
| LiquoFill seal kit for 5913-0020, -2020 | 182.15  | 5913-0006 NO |
| LiquoFill seal kit for 5913-0200, -2200 | 261.20  | 5913-0007 NO |
| LiquoFill seal kit for 5913-0500, -2500 | 324.60  | 5913-0008 NO |

### LiquoFill pro filler, semi-automatic drive

Cost-effective semi-automatic filling machine with reproducible speed setting. With start contact via foot-operated switch. With handwheel and display for precise, stepless adjustment of the metering volume. Housing dimensions: LxWxH 1150 x 135 x 370 mm.

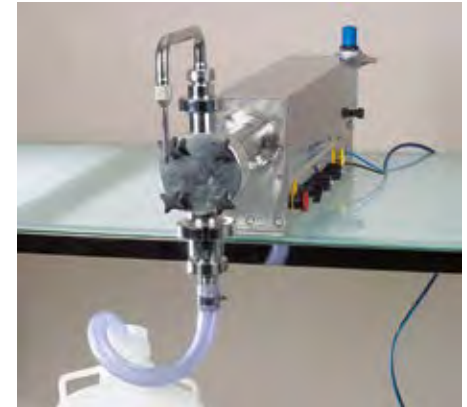

#### LiquoFill pro filler, semi-automatic drive

| Dosing volume ml | Filling nozzle dia. mm | Price € | Item no.     |
|------------------|------------------------|---------|--------------|
| 5 - 60           | 6/4                    | 7358.85 | 5913-4060 NO |
| 30 - 300         | 8/6                    | 7404.65 | 5913-4300 NO |
| 80 - 1050        | 10/8                   | 7678.60 | 5913-4550 NO |

#### Accessories

| Description                              | Price € | Item no.     |
|--|---------|--------------|
| Height-adjustable filler                 | 544.20  | 5913-0001 NO |
| LiquoFill filling funnel, approx. 10l    | 1266.20 | 5913-0002 NO |
| LiquoFill pro exchange kit, 5 - 60 ml    | 791.40  | 5913-4001 NO |
| LiquoFill pro exchange kit, 30 - 330 ml  | 840.80  | 5913-4002 NO |
| LiquoFill pro exchange kit, 80 - 1050 ml | 1147.50 | 5913-4003 NO |
| LiquoFill pro seal kit for 5913-4060     | 221.75  | 5913-4004 NO |
| LiquoFill pro seal kit for 5913-4300     | 261.20  | 5913-4005 NO |
| LiquoFill pro seal kit for 5913-4550     | 395.80  | 5913-4006 NO |
| Pneumatic drip preventer                 | 1394.80 | 5913-2000 NO |

## PastoFill filler for pasty substances



The PastoFill filler was specially developed for manual filling of highly viscous products. PastoFill is handy especially in small series, as the purchase of a stationary filling station designed mostly in large series is often not profitable.

The metering and filling devices are used in production sites and laboratories for cosmetic, pharmaceutical and chemical products, creams, salves as well as in the food and beverage industry.

PastoFill is ready to operate, simple to handle and easy to clean. The fillers can be mounted on the table using a fastener or screwed directly on to the table; they are portable and therefore usable at different places.

The fill quantity can be calibrated precisely and continuously using an adjusting nut, without any tools and can be read at a display.

Parts in contact with the medium are made of stainless steel V4A (1.4404/1.4571), PETP, NBR, PTFE and FCR (Fluorocarbon rubber). Housing made of cast aluminum. Housing dimensions: LxWxH 740 x 500 x 510 mm.

Different filling nozzles (Ø6/4 mm - Ø22/20 mm) facilitate individual filling of diverse containers such as bottles, tubes, nozzles, crucibles or glasses. Do not forget to indicate the desired size while ordering filling nozzles.

- ▶ Including feeding funnels 10 l
- ▶ Metering accuracy +/- 0.5 %
- ▶ 300 - 600 fillings per hour
- ▶ Self-feeding made of stainless steel funnel

### Accessories:

- ▶ Filling nozzles for crucible and tube filling in different diameters
- ▶ Cover for feeding funnel

When ordering, please state the material to be filled. We will test the chemical resistance. Please always indicate the desired size when ordering filling tubes.

| PastoFill filler for pasty substances            |                        |           |              |
|--|------------------------|-----------|--------------|
| Dosing volume ml                                 | Filling nozzle dia. mm | Price €   | Item no.     |
| 10 - 160   | 14/12                  | 4747.65   | 5913-1160 NO |
| 30 - 260   | 14/12                  | 5242.30   | 5913-1260 NO |
| Accessories                                      |                        |           |              |
| Description                                      | Price €                | Item no.  |              |
| PastoFill exchange kit for 5913-1160, 3 - 15 ml  | 1157.45                | 5913-1110 | NO           |
| PastoFill exchange kit for 5913-1260, 10 - 50 ml | 1157.45                | 5913-1111 | NO           |

## Drain safety stand



Residual liquid from pump tubes or samplers can be reliably collected with the drain safety stand. The safety stand is resistant to diluted bases and acids. The collecting container can be filled with a neutralisation medium which dilutes and neutralises residual liquid.

The stand pipe is mounted on the wall with sturdy pipe clamps. The pipe clamps can simply be opened to remove the safety stand.

The container for collecting liquid can be unscrewed, making it convenient to replace or empty.

### Drain safety stand

| Total length cm | Inner dia. mm | Price € | Quantity scale from | Scale price € | Item no.     |
|-----------------|---------------|---------|---------------------|---------------|--------------|
| 117             | 35            | 45.30   | 5                   | 40.80         | 5618-1000 N4 |

## General pump accessories



Threads can be ideally sealed with the sealing tape for threads made of PTFE. Low abrasion, excellent chemical resistance, temperature resistant from -80°C to +260°C.

### Sealing tape PTFE

| Width mm | Length m | Price € | Quantity scale from | Scale price € | Item no.     |
|----------|----------|---------|---------------------|---------------|--------------|
| 12       | 12       | 1.55    | 10                  | 1.41          | 0006-4514 N3 |



Universal barrel key for effortless opening even of tight barrel closures 3/4" to 2". An unbreakable tool made of zinc-plated steel.

### Universal barrel spanner

| Price € | Quantity scale from | Scale price € | Item no.     |
|---------|---------------------|---------------|--------------|
| 31.10   | 10                  | 27.80         | 5690-0090 N4 |



Hexagonal nut with inner thread.

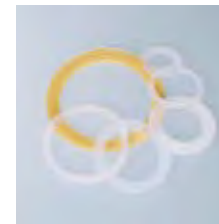

Flat seals made of Polyethylene, transparent fitting outer or inner thread.

▶ PE

### Hexagonal nuts

| Thread | Material | Price € | Quantity scale from | Scale price € | Item no.     |
|--------|----------|---------|---------------------|---------------|--------------|
| 1/2"   | HDPE     | 2.02    | 10                  | 1.85          | 8537-0012 N3 |
| 3/4"   | HDPE     | 2.30    | 10                  | 2.09          | 8537-0034 N3 |
| 1"     | HDPE     | 2.51    | 10                  | 2.31          | 8537-0100 N3 |
| 2"     | PP       | 3.76    | 10                  | 3.40          | 8537-0200 N3 |

### Flat seals, PE

| Thread | Model             | Pieces per pack | Price € | Quantity scale from | Scale price € | Item no.     |
|--------|-------------------|-----------------|---------|---------------------|---------------|--------------|
| 1/2"   | fits outer thread | 10              | 2.40    | 10                  | 2.18          | 8538-0012 N3 |
| 3/4"   | fits outer thread | 10              | 2.49    | 10                  | 2.42          | 8538-0034 N3 |
| 1"     | fits outer thread | 10              | 4.96    | 10                  | 4.50          | 8538-0100 N3 |
| 2"     | fits outer thread | 10              | 12.05   | 10                  | 10.80         | 8538-0200 N3 |
| 1/2"   | fits inner thread | 10              | 2.35    | 10                  | 2.12          | 8539-0012 N3 |
| 3/4"   | fits inner thread | 10              | 2.43    | 10                  | 2.37          | 8539-0034 N3 |
| 1"     | fits inner thread | 10              | 4.84    | 10                  | 4.46          | 8539-0100 N3 |

## Rubiflex gloves



With short or long gauntlet.  
Safe working with fats, mineral oils, solvents and many acids and alkalis.

- ▶ Made from nitrile rubber
- ▶ Very flexible, soft to the touch
- ▶ High abrasion and cut resistance
- ▶ Comfortable cotton interlock interior
- ▶ To standard EN 374

**!** Attention! Make sure to pay attention to the "List of Chemical Resistance"!

| Rubiflex protective gloves |           |         |                     |               |              |
|----------------------------|-----------|---------|---------------------|---------------|--------------|
| Model                      | Length cm | Price € | Quantity scale from | Scale price € | Item no.     |
| ① standard                 | 37        | 23.95   | 10                  | 21.90         | 2507-0002 N3 |
| ② long wrist               | 60        | 45.75   | 10                  | 41.65         | 2507-0003 N3 |

| Protective gloves nitrile |                     |               |              |
|---------------------------|---------------------|---------------|--------------|
| Price €                   | Quantity scale from | Scale price € | Item no.     |
| ③ 6.65                    | 10                  | 6.05          | 2507-0004 N3 |

## Nitrile gloves



Made of nitrile, proven when handling acids, fats and solvents.

## Plastic apron made of PVC

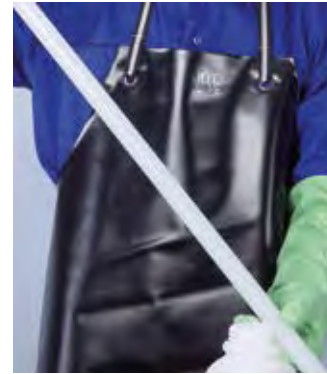

Plastic apron made of PVC with eyelets, neck band and waist band welded into the apron, industry quality, black, fabric reinforced, size 80 cm x 100 cm.

**!** Attention! Make sure to pay attention to the "List of Chemical Resistance"!

| Plastic apron made of PVC |                     |               |              |
|---------------------------|---------------------|---------------|--------------|
| Price €                   | Quantity scale from | Scale price € | Item no.     |
| 27.10                     | 10                  | 24.75         | 2507-1001 N3 |

## SafetyBox



Panorama safety goggles and protective gloves made of nitrile for personal safety, stored cleanly in a box. Recommended by trade associations.

**!** Attention! Make sure to pay attention to the "List of Chemical Resistance"!

| SafetyBox |                     |               |              |
|-----------|---------------------|---------------|--------------|
| Price €   | Quantity scale from | Scale price € | Item no.     |
| 38.00     | 10                  | 34.35         | 2507-9000 N3 |

## Eyes Fresh mini eyewash station



Mini eyewash station ideal for the lab, filling stations or all work places where aggressive substances are used. Eyes Fresh can be attached to any standard cold water tap. For normal use of the tap, just press the button and the function changes back from the eye wash (returns automatically to eyewash-function when the tap is closed). Can be fitted onto taps with M22x1, 1/2" or 3/8" outer thread. With sufficient water pressure provided, performance according to DIN EN 15154-2.

| Eyes Fresh mini eyewash station |         |                     |               | DIN          |
|---------------------------------|---------|---------------------|---------------|--------------|
| Model                           | Price € | Quantity scale from | Scale price € | Item no.     |
| Press button for normal use     | 137.05  | 5                   | 126.10        | 2515-0100 N4 |

## Eye rinsing bottle



Empty bottle for 600 ml contents, leakproof due to valve and dust protection cap. Instructions printed on (in German language), made of transparent PE.

| Eye rinsing bottle |                     |               |           | DIN |
|--------------------|---------------------|---------------|-----------|-----|
| Price €            | Quantity scale from | Scale price € | Item no.  |     |
| 30.10              | 10                  | 27.30         | 2507-2000 | N3  |
| Wall fixture       |                     |               |           |     |
| Price €            | Quantity scale from | Scale price € | Item no.  |     |
| 15.65              | 10                  | 15.00         | 2507-2001 | N3  |

## Eye protection / safety goggles



Ultra light build of only 18 grammes total weight. Maximum flexibility, perfect and slip-free fit.

| Safety goggles Ultralight |         |                     |               |              |
|---------------------------|---------|---------------------|---------------|--------------|
| Colour                    | Price € | Quantity scale from | Scale price € | Item no.     |
| blue                      | 23.95   | 5                   | 22.85         | 2502-1002 N3 |



Ultra-light protective goggles with sporty design, maximum wearing comfort, according to DIN/EN standard.

| Casual style safety goggles |         |                     |               |              |
|-----------------------------|---------|---------------------|---------------|--------------|
| Colour                      | Price € | Quantity scale from | Scale price € | Item no.     |
| blue/orange                 | 25.15   | 5                   | 23.85         | 2502-2010 N3 |



Over-goggles with hingeless side pieces and with soft side piece ends. Combines the advantages of goggles with side pieces with the wearing properties of head-bands. The flexible side piece design allows it to adapt to different wearing situations, with or without glasses. DIN EN 166 - 168 and 170.

| Safety goggles Ultraflex |         |                     |               |              |
|--------------------------|---------|---------------------|---------------|--------------|
| Colour                   | Price € | Quantity scale from | Scale price € | Item no.     |
| blue                     | 27.00   | 5                   | 25.55         | 2502-1003 N3 |



With anatomically designed wrap-around screen for an increased degree of safety. Unrestricted view in all directions, larger cover by 20% compared with normal glasses with side pieces, UV protection up to 400 nm.

| Safety goggles Style |         |                     |               |              |
|----------------------|---------|---------------------|---------------|--------------|
| Colour               | Price € | Quantity scale from | Scale price € | Item no.     |
| black                | 18.45   | 5                   | 17.65         | 2502-1006 N3 |



Lightweight, unrestricted lateral sight, variable side pieces and side piece length which can be set to 4 different lengths guarantee the perfect fit without pressure points due to Duo-Flex side pieces, lateral safety shields integrated in the goggle's lens, according to DIN EN 166-168 and 170.

| Astrolite safety goggles |         |                     |               |              |
|--------------------------|---------|---------------------|---------------|--------------|
| Colour                   | Price € | Quantity scale from | Scale price € | Item no.     |
| black/blue               | 18.85   | 5                   | 17.05         | 2502-4000 N3 |
| black/red                | 18.85   | 5                   | 17.05         | 2502-4001 N3 |

## Eye protection / safety goggles



Anti-fog lens, suitable for wearers of glasses, with ventilation system, unrestricted lateral view, close fitting, pressure-free fit, according to DIN/EN standard.



Various colours, pleasantly light. Good adjustability from the option for setting the side pieces to 4 lengths. Shield made of polycarbonate, resistant to high impact with integrated lateral protection. Maximum UV protection.



Very comfortable over-goggles with unrestricted side view, suitable to go over most glasses. 180° field of vision, lateral ventilation through the side shields. Side pieces can be adjusted to 4 lengths. Without coating. With Polycarbonate side pieces. According to DIN EN 166 -168 and 170.

► Ideal as goggles for visitors



Extremely robust eye-wear case with reinforced zipper and belt loop. Suitable for all spectacles, not for safety goggles Ultravision.



Very robust large eye-wear case for panoramic goggles with zipper, belt loop and additional compartment. Suitable for all spectacles and panoramic goggles.

### Ultravision safety goggles

| Colour | Price € | Quantity scale from | Scale price € | Item no.     |
|--------|---------|---------------------|---------------|--------------|
| orange | 27.15   | 5                   | 25.80         | 2502-1007 N3 |

### Color safety spectacles

| Colour       | Price € | Quantity scale from | Scale price € | Item no.     |
|--------------|---------|---------------------|---------------|--------------|
| yellow/black | 17.85   | 5                   | 16.45         | 2502-1004 N3 |
| blue         | 17.85   | 5                   | 16.45         | 2502-1005 N3 |
| silver gray  | 17.85   | 5                   | 16.45         | 2502-1010 N3 |
| violet/green | 17.85   | 5                   | 16.45         | 2502-1012 N3 |

### Panorama safety goggles

| Colour      | Price € | Quantity scale from | Scale price € | Item no.     |
|-------------|---------|---------------------|---------------|--------------|
| glass clear | 10.80   | 5                   | 9.85          | 2502-1001 N3 |

### Case with belt loop for all glasses with temple

| Colour | Price € | Quantity scale from | Scale price € | Item no.     |
|--------|---------|---------------------|---------------|--------------|
| black  | 10.75   | 5                   | 10.20         | 2502-1008 N3 |

### Case with belt loop for all glasses and goggles

| Colour | Price € | Quantity scale from | Scale price € | Item no.     |
|--------|---------|---------------------|---------------|--------------|
| black  | 16.00   | 5                   | 15.30         | 2502-1009 N3 |

## Table of contents samplers

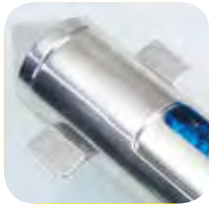

|           |                                       |
|-----------|---------------------------------------|
| 68 – 85   | Samplers for bulk goods               |
| 68 – 73   | Zone samplers                         |
| 79 – 82   | Samplers for pharmaceutical products  |
| 82 – 85   | Bag/sack samplers                     |
| 86 – 93   | Accessories for bulk samplers         |
| 94 – 98   | Samplers for viscous substances       |
| 99 – 123  | Samplers for liquids                  |
| 108 – 115 | Vacuum samplers                       |
| 116 – 120 | Dipping bottles                       |
| 121 – 134 | Disposable & sterile samplers         |
| 128 – 145 | Scoops, scrapers, spoons and spatulas |
| 146 – 147 | Ice and meat sampling                 |
| 148 – 149 | Soil sampling                         |
| 150 – 153 | Accessories for samplers              |





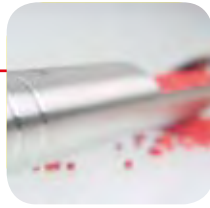

## Samplers

Sampling from liquids, bulk goods and viscous media

## Take samples – but do it right!

### Taking samples

When taking samples, a random test is taken from an overall quantity. These samples serve as the basis for the analysis regarding quality assurance. The correct procedure for taking spot samples is therefore a very important subject. Only with representative and authentic samples can reliable information about the quality, properties or composition of a particular material be provided.

Very precise material analyses can be carried out with the most up-to-date technology. However, the technology is no good if an error occurs when the sample is taken and this error continues through all phases of the analysis, with the consequence that the final result of the quality check is wrong.

Correct information about the properties of a material can only be provided if the sample is taken properly and treated in the same way as in the subsequent analysis. The basic point is that the properties and composition of the sample quantity correspond exactly with the material quantity that has to be evaluated.

### Taking samples - but how?

When taking samples, some essential stipulations such as DIN-standards have to be complied with. The recommendation is to fol-



low a company-internal checklist which should be a fixed component of a company's quality standards. All relevant steps for taking samples are documented in this checklist so that they can be traced at any time.

### Location for taking samples

The location from where the samples are taken has to be as clean as possible. At the very least, the use of clean samplers, equipment and tools has to be considered. During the procedure, no external



factors must influence the sampling. Even small external contamination can significantly alter the examination result. Detergents which are used to clean the samplers or the sample packaging can also falsify the result of the analysis.

### Taking samples - but who? - Qualified personnel

Only skilled personnel should take the samples. It must be guaranteed that sampling is carried out exactly in accordance with the stipulated DIN-standards or internal guidelines.

Technical knowledge is of utmost importance because altered circumstances can only be reacted to on-site. Only trained personnel can quickly and safely recognise mistakes that occur or altered circumstances and react accordingly.

## Taking samples - with what? - Sampling equipment



Choosing the right sampling equipment depends on many different selection criteria. It depends on the material properties of the sampler as well as on the type of sampling, the container or the site where the material is located, and the frequency with which the sampling has to be carried out. In addition to individual requirements for sampling, all equipment should fulfil the basic principles explained below:



### Sampler material

The equipment should be made of inert substances from which no material can come loose and which does not react with other substances and therefore cannot contaminate the sample. The inert substance depends on the medium to be sampled. As a general rule, samplers made of stainless steel and high-quality

plastic such as PTFE are very suitable

### Cleaning the sampling equipment

It should be easy and quick to clean the equipment and – under certain conditions – to sterilise it. In the food industry, sterile-packed disposable samplers are recommended which can be disposed of after use.

### Processing the samplers

Samplers must not have any grooves or crevices because residual material collects in such crevices and cannot be easily removed. This means that cross-contamination and memory effects can no longer be ruled out.

### Surface of the equipment

The samplers' surfaces have to be especially smooth, for example, electro-polished stainless steel or PTFE. This prevents material from being deposited and simplifies cleaning. When selecting the appropriate sampling equipment, you must ensure that it is finished properly on the inside. Equipment with only a smooth external surface will not meet any quality standards.

### Sampling techniques – physical and analytical sampling

A distinction is made between physical and analytical/chemical sampling.

During **physical sampling**, the bulk density, material distribution, material properties and – if required – colouring or contamination are determined. It is especially important in this case that the sampler does not change or destroy the material's properties while taking the sample. A sample taken onsite still has to be transported. During packing and transport, the same high quality standards should apply as during sampling, so that the sample reaches the laboratory unaltered.

During **analytical sampling**, special attention must be paid to cleanliness in addition to the aspects listed above. However, the material properties can be disregarded at times because the sample will be specially processed. In this case, equipment can be used which changes the physical properties of the material.

## Sampling techniques

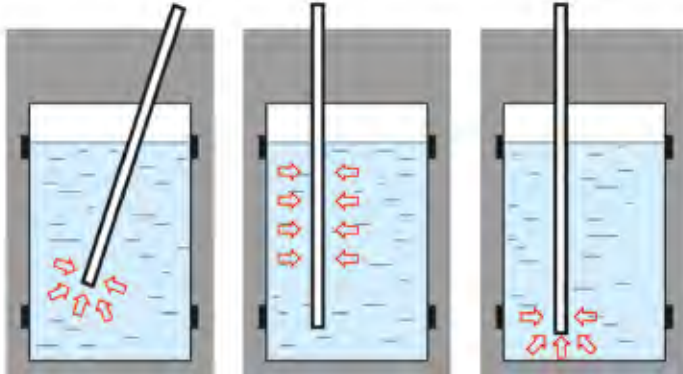

From the left to the right: Point sampling, cross-sectional sampling, bottom sampling

### Cross-sectional sampling

A sample is taken through all material layers to provide a representative cross-section.

### Point sampling

A targeted sample is taken from a pre-determined point. This is done to determine the condition of the material precisely at this point, or several point samples are taken over a larger area or in a large volume container to get an authentic cross-section. All point samples together therefore provide a representative cross-section.

## Completing the sampling procedure

After the sample has been taken, it must be packed for transport. Clean sampling containers connected directly to the sampling equipment are ideal. The sample has no contact with the environment and is packed for transport at the same time. The same conditions that relate to the sampling equipment also apply to packaging, storage, and transport of a sample.



Here, too, you must pay attention to the cleanliness of the packaging material and the risk of contamination from loose substances. The sample container is then labelled so that no mix-up can occur and taken to the laboratory – if necessary in coolers. Coolers with temperature monitors in which the ideal cooling temperature is maintained, are recommended.

### Advice

If samples are taken from sacks or bags, the insertion points must be closed again afterwards. For this, special labels should be used that stick firmly to dirty surfaces and can be written on.



### Any questions?

We will be happy to advise you. Talk to us - telephone +49 7635 82795-0. Or send an email to [info@buerkle.de](mailto:info@buerkle.de).

Bürkle GmbH - your partner for all questions about manual sampling.

# Overview on sampling equipment

| Product                             | Page | Liquids, normal | Liquids, aggressive | Liquids, flammable | Viscous substances/muds | Ice | Bulk goods, powders | Soil sampling | Transport of samples | Pharma | Sterile | Accessories |
|-------------------------------------|------|-----------------|---------------------|--------------------|-------------------------|-----|---------------------|---------------|----------------------|--------|---------|-------------|
| Zone sampler                        | 68   |                 |                     |                    |                         |     | x                   |               |                      | x      |         |             |
| All-layer sampler                   | 69   |                 |                     |                    |                         |     | x                   |               |                      | x      |         |             |
| EasySampler                         | 71   |                 |                     |                    |                         |     | x                   |               |                      | x      |         |             |
| Spiralus zone sampler               | 71   |                 |                     |                    |                         |     | x                   |               |                      |        |         |             |
| All-layer drill                     | 72   |                 |                     |                    |                         |     | x                   |               |                      |        |         |             |
| All-layer-scratcher                 | 73   |                 |                     |                    | x                       |     | x                   |               |                      |        |         |             |
| Scratcher                           | 73   |                 |                     |                    | x                       |     | x                   |               |                      |        |         |             |
| PowderProof®                        | 74   |                 |                     |                    |                         |     | x                   |               |                      | x      |         |             |
| SiloDrill                           | 76   |                 |                     |                    |                         |     | x                   |               |                      |        |         |             |
| SiloPicker                          | 78   |                 |                     |                    |                         |     | x                   |               |                      |        |         |             |
| Novartos                            | 79   |                 |                     |                    |                         |     | x                   |               |                      | x      |         |             |
| MicroSampler                        | 80   |                 |                     |                    |                         |     | x                   |               |                      | x      |         |             |
| PharmaPicker                        | 81   |                 |                     |                    |                         |     | x                   |               |                      | x      |         |             |
| PharmaSpoon                         | 82   |                 |                     |                    | x                       |     | x                   |               |                      |        |         |             |
| StickProof                          | 82   |                 |                     |                    |                         |     | x                   |               |                      | x      |         |             |
| Milky                               | 83   |                 |                     |                    |                         |     | x                   |               |                      | x      |         |             |
| Tubus                               | 83   |                 |                     |                    |                         |     | x                   |               |                      | x      |         |             |
| QuickPicker                         | 84   |                 |                     |                    |                         |     | x                   |               |                      | x      |         |             |
| close-it control-seal               | 86   |                 |                     |                    |                         |     | x                   |               | x                    |        |         | x           |
| close-it food & pharma              | 88   |                 |                     |                    |                         |     | x                   |               | x                    | x      |         | x           |
| close-it tape/food & pharma seal-it | 89   |                 |                     |                    |                         |     | x                   |               | x                    | x      |         | x           |
| safe-it, secure-it                  | 91   |                 |                     |                    |                         |     |                     |               | x                    |        |         | x           |
| SampleSafe seal                     | 92   |                 |                     |                    |                         |     |                     |               | x                    |        |         | x           |
| Valve lance                         | 93   |                 |                     |                    |                         |     |                     |               | x                    |        |         | x           |
| Pigment lance                       | 94   |                 |                     |                    | x                       |     | x                   |               |                      |        |         |             |
| QualiRod                            | 94   |                 |                     |                    | x                       |     |                     |               |                      |        |         |             |
| Spatula                             | 95   |                 |                     |                    | x                       |     |                     |               |                      |        |         | x           |
| Spatula stainless steel             | 96   |                 |                     |                    | x                       |     | x                   |               |                      | x      |         |             |
| Mini ViscoSampler                   | 97   |                 |                     |                    | x                       |     |                     |               |                      | x      |         |             |
| Stainless steel scoop               | 97   | x               |                     | x                  | x                       |     | x                   |               |                      | x      | x       |             |
| ViscoSampler                        | 98   |                 |                     |                    | x                       |     |                     |               |                      |        |         |             |
| LiquiSampler                        | 99   | x               | x                   |                    |                         |     |                     |               |                      |        |         |             |
| Dip Sampler                         | 100  | x               |                     |                    |                         |     |                     |               |                      |        |         |             |
| Disposable plunging siphon          | 101  | x               | x                   |                    |                         |     |                     |               |                      |        |         |             |
| Scoop made of PTFE                  | 101  | x               | x                   |                    |                         |     |                     |               |                      | x      |         |             |
| Chemistry scoop                     | 102  | x               | x                   |                    | x                       |     |                     |               |                      |        |         |             |
| Liquid-sampler                      | 103  | x               |                     |                    |                         |     |                     |               |                      |        |         |             |
| TeleScoop                           | 104  | x               |                     |                    |                         |     |                     |               |                      |        |         |             |
| Stainless steel beaker              | 105  | x               |                     |                    | x                       |     | x                   |               |                      |        |         |             |
| ChemoSampler                        | 106  | x               | x                   |                    |                         |     |                     |               |                      |        |         |             |
| MiniSampler                         | 108  | x               | x                   |                    |                         |     |                     |               |                      |        |         |             |
| ProfiSampler                        | 110  | x               | x                   |                    |                         |     |                     |               |                      |        |         |             |
| Liqui zone sampler                  | 112  | x               | x                   |                    |                         |     |                     |               |                      |        |         |             |
| UniSampler                          | 113  | x               |                     |                    |                         |     |                     |               |                      |        |         |             |

| Product                    | Page | Liquids, normal | Liquids, aggressive | Liquids, flammable | Viscous substances/muds | Ice | Bulk goods, powders | Soil sampling | Transport of samples | Pharma | Sterile | Accessories |
|----------------------------|------|-----------------|---------------------|--------------------|-------------------------|-----|---------------------|---------------|----------------------|--------|---------|-------------|
| UniSampler "Ex"            | 113  | x               |                     | x                  |                         |     |                     |               |                      |        |         |             |
| Vampire                    | 115  | x               | x                   |                    |                         |     |                     |               |                      |        |         |             |
| Dipping bottle             | 116  | x               |                     | x                  |                         |     |                     |               |                      |        |         |             |
| Immersion cylinder         | 117  | x               |                     | x                  |                         |     |                     |               |                      |        |         |             |
| Dipping bottle Ex          | 117  | x               |                     | x                  |                         |     |                     |               |                      |        |         |             |
| Immersion cylinder Mini    | 118  | x               |                     | x                  |                         |     |                     |               |                      |        |         |             |
| Dipping vessel             | 118  | x               |                     | x                  |                         |     |                     |               |                      |        |         |             |
| AquaSampler                | 119  | x               | x                   |                    |                         |     |                     |               |                      |        |         |             |
| Target immersion cylinder  | 119  | x               |                     |                    |                         |     |                     |               |                      |        |         |             |
| Disposable Disposampler    | 121  | x               | x                   |                    | x                       |     | x                   |               |                      | x      | x       |             |
| LiquiDispo                 | 122  | x               | x                   |                    |                         |     |                     |               |                      | x      | x       |             |
| DispoPipette               | 122  | x               | x                   |                    |                         |     |                     |               |                      | x      | x       |             |
| ViscoDispo                 | 123  | x               | x                   |                    | x                       |     |                     |               |                      | x      | x       |             |
| DispoTube                  | 123  | x               | x                   |                    |                         |     |                     |               |                      | x      | x       |             |
| PowderDispo                | 124  |                 |                     |                    |                         |     | x                   |               |                      | x      | x       |             |
| DispoPicker                | 124  |                 |                     |                    |                         |     | x                   |               |                      | x      | x       |             |
| DispoLance                 | 125  |                 |                     |                    |                         |     | x                   |               |                      | x      | x       |             |
| MicroDispo                 | 125  |                 |                     |                    |                         |     | x                   |               |                      | x      | x       |             |
| MultiDispo                 | 126  |                 |                     |                    |                         |     | x                   |               |                      | x      | x       |             |
| TargetDispo                | 127  |                 |                     |                    |                         |     | x                   |               |                      | x      | x       |             |
| ZoneDispo                  | 127  |                 |                     |                    |                         |     | x                   |               |                      | x      | x       |             |
| SteriPlast® scoops         | 129  |                 |                     |                    | x                       |     | x                   |               |                      | x      | x       |             |
| SteriPlast® spatula        | 130  |                 |                     |                    | x                       |     | x                   |               |                      | x      | x       |             |
| SteriPlast® sample spoons  | 131  | x               |                     |                    | x                       | x   | x                   |               |                      | x      | x       |             |
| SteriBag                   | 132  | x               |                     |                    | x                       | x   | x                   | x             | x                    | x      | x       |             |
| SteriBag StandUp           | 133  | x               |                     |                    | x                       | x   | x                   | x             | x                    | x      | x       |             |
| SteriPlast® sampling tube  | 134  | x               | x                   |                    |                         |     |                     |               |                      | x      | x       |             |
| SteriPlast® syringe        | 134  | x               | x                   |                    | x                       |     |                     |               |                      | x      | x       |             |
| EasyScoop                  | 136  |                 |                     |                    |                         |     | x                   |               |                      |        |         |             |
| Scoop V2A (304)            | 136  |                 |                     |                    | x                       | x   | x                   |               |                      |        |         |             |
| FoodScoop                  | 137  |                 |                     |                    | x                       |     | x                   |               |                      |        |         |             |
| PharmaScoop                | 137  |                 |                     |                    | x                       |     | x                   |               |                      | x      |         |             |
| LaboPlast® scoops          | 141  |                 |                     |                    | x                       |     | x                   |               |                      | x      |         |             |
| LaboPlast® spatula         | 142  |                 |                     |                    | x                       |     | x                   |               |                      | x      |         |             |
| LaboPlast® sample spoons   | 143  | x               |                     |                    | x                       | x   | x                   |               |                      | x      |         |             |
| Scrapers                   | 144  |                 |                     |                    | x                       | x   |                     |               |                      |        |         |             |
| Scoops made of PP          | 144  |                 |                     |                    |                         |     | x                   | x             |                      |        |         |             |
| Beefsteaker                | 146  |                 |                     |                    | x                       |     |                     |               |                      |        |         |             |
| IceSampler                 | 146  |                 |                     |                    | x                       | x   |                     |               |                      |        |         |             |
| Ice Drill                  | 147  |                 |                     |                    | x                       | x   |                     |               |                      |        |         |             |
| GeoSampler                 | 148  |                 |                     |                    |                         |     |                     |               |                      | x      |         |             |
| Pürckhauer                 | 148  |                 |                     |                    |                         |     |                     |               |                      | x      |         |             |
| Mole                       | 149  |                 |                     |                    |                         |     |                     |               |                      | x      |         |             |
| SnowPack® dry ice machines | 150  |                 |                     |                    |                         | x   |                     |               |                      | x      |         |             |
| Sampling containers        | 151  |                 |                     |                    |                         |     |                     |               |                      | x      | x       | x           |

## Zone samplers | for all kinds of bulk goods



1. Multi sampler (closed chambers)
2. All layer sampler (open inner tube)
3. Uno sampler (one closed chamber)

Bürkle zone samplers are used for taking samples of bulk goods of any kind.

The big advantage of zone samplers is that all-layer samples can be collected from all layers of the container.

Various bulk goods can be collected with the lances, from the finest powder to large grains such as corn or nuts.

The zone samplers are available in different lengths. 55 cm (only Multi, Uno and All-layer sampler) especially suitable for sacks, 85 cm long (especially for barrels, tubs, mixed containers) and 150 cm as well as 250 cm (only Jumbo sampler) for big bags, silos, tanks.

Safe and reliable sampling is made even easier with useful special accessories such as sealing sleeves, Quali-Paper, cleaning brushes, emptying devices and close-it control seals.

The zone samplers are available in different models for different sampling tasks.

- ▶ Smallest possible gap between the inner and the outer tube
- ▶ Easy cleaning, removable tip
- ▶ Colour coding (Multi and Uno sampler)
- ▶ Ultra-pure materials
- ▶ Excellent processing, robust model



Colour coding: Identification to prevent mixing up multi samplers and single samplers.

## Zone samplers | for all kinds of bulk goods



All-layer sampler, with open inner tube, no separate chambers, and large sampling volume. For all-layer samples through all the layers of the sample.

- ▶ Aluminium or V4A (1.4404)
- ▶ 25 mm Ø

Corresponds to ISTA standard for seed lengths of 10 mm (wheat, oats) and 5 mm (flax, vetches).



Multi sampler with several closed chambers, for multi point sampling from several predetermined sampling depths.

- ▶ Aluminium, V4A (1.4404) or V4A/PTFE
- ▶ Version made of V4A/PTFE with low weight due to PTFE sample chambers.
- ▶ With colour coding system
- ▶ 25 mm Ø



Uno sampler made of stainless steel V4A/PTFE with a closed sample chamber for point sampling from a predetermined sampling depth.

- ▶ Outer tube stainless steel V4A (1.4404), sample chambers made of PTFE
- ▶ With colour coding system
- ▶ 25 mm Ø



close-it seals openings. See page 86.

### All-layer-sampler

| Material  | Total length cm | Insertion depth mm | No. of openings | Chamber volume ml | Price € | Item no.     |
|-----------|-----------------|--------------------|-----------------|-------------------|---------|--------------|
| aluminium | 55              | 430                | 3               | 70                | 169.50  | 5317-2055 N4 |
| aluminium | 85              | 710                | 3               | 130               | 184.10  | 5317-2085 N4 |
| aluminium | 150             | 1355               | 5               | 260               | 239.80  | 5317-2150 N4 |
| V4A       | 55              | 430                | 3               | 70                | 524.95  | 5316-2055 N4 |
| V4A       | 85              | 710                | 3               | 130               | 605.25  | 5316-2085 N4 |
| V4A       | 150             | 1355               | 5               | 260               | 728.65  | 5316-2150 N4 |

### Multi sampler

| Material  | Total length cm | Insertion depth mm | Number of collection chambers | Chamber volume ml | Price € | Item no.     |
|-----------|-----------------|--------------------|-------------------------------|-------------------|---------|--------------|
| aluminium | 55              | 430                | 3                             | 14                | 188.15  | 5317-1058 N4 |
| aluminium | 85              | 710                | 3                             | 17                | 209.25  | 5317-1085 N4 |
| aluminium | 150             | 1355               | 5                             | 17                | 270.15  | 5317-1150 N4 |
| V4A       | 55              | 430                | 3                             | 14                | 573.05  | 5316-3055 N4 |
| V4A       | 85              | 710                | 3                             | 17                | 613.85  | 5316-3085 N4 |
| V4A       | 150             | 1355               | 5                             | 17                | 776.75  | 5316-3150 N4 |
| V4A/PTFE  | 55              | 430                | 3                             | 14                | 373.10  | 5316-0055 N4 |
| V4A/PTFE  | 85              | 710                | 3                             | 17                | 418.65  | 5316-0085 N4 |
| V4A/PTFE  | 150             | 1355               | 5                             | 17                | 611.40  | 5316-0150 N4 |

### Uno sampler

| Material | Total length cm | Insertion depth mm | Number of collection chambers | Chamber volume ml | Price € | Item no.     |
|----------|-----------------|--------------------|-------------------------------|-------------------|---------|--------------|
| V4A/PTFE | 55              | 430                | 1                             | 17                | 380.40  | 5316-1055 N4 |
| V4A/PTFE | 85              | 710                | 1                             | 17                | 426.15  | 5316-1085 N4 |
| V4A/PTFE | 150             | 1355               | 1                             | 17                | 623.70  | 5316-1150 N4 |

### Use

1. Turn the handle, close the chambers.
2. Insert the sampler to the required depth.
3. Open the chambers, sample flows into the chamber.
4. Close the chambers.
5. Pull out the sampler.
6. Close the insertion opening with the close-it control seal.
7. Empty the chambers onto Quali-Paper or with the emptying device.

## Zone samplers | for all kinds of bulk goods



Jumbo sampler with a tube diameter of 50 mm, ideal for coarse grains and larger quantities. With an open inner tube and large sampling volume, for all-layer samples through all layers of the sample or with sample chambers separated by PTFE separators for multi point sampling from several predetermined sampling depths.

- ▶ Aluminium or aluminium/PTFE
- ▶ 50 mm Ø

### Jumbo sampler

| Model                       | Total length cm | Material       | Insertion depth mm | No. of openings | Chamber volume ml | Price € | Item no.     |
|-----------------------------|-----------------|----------------|--------------------|-----------------|-------------------|---------|--------------|
| All layer - open inner tube | 85              | aluminium      | 710                | 3               | 880               | 391.45  | 5319-1085 N4 |
| All layer - open inner tube | 150             | aluminium      | 1355               | 5               | 1700              | 554.25  | 5319-1150 N4 |
| All layer - open inner tube | 250             | aluminium      | 2355               | 7               | 2900              | 626.00  | 5319-1250 N4 |
| Multi - closed chambers     | 85              | aluminium/PTFE | 710                | 3               | 390               | 605.05  | 5319-2085 N4 |
| Multi - closed chambers     | 150             | aluminium/PTFE | 1355               | 5               | 650               | 711.10  | 5319-2150 N4 |
| Multi - closed chambers     | 250             | aluminium/PTFE | 2355               | 7               | 910               | 849.30  | 5319-2250 N4 |



## Accessories for zone samplers



Emptying device



Zone sampler sealing sleeves



Quali-Paper for zone sampler



Cleaning brushes

### Emptying device

| Model                    | Material | Length cm | Price € | Quantity scale from | Scale price € | Item no.     |
|--------------------------|----------|-----------|---------|---------------------|---------------|--------------|
| device with 3 funnels    | V2A      | 100       | 307.45  | 5                   | 281.45        | 5317-0030 N4 |
| emptying funnel separate | V2A      |           | 47.90   | 3                   | 43.40         | 5317-0033 N4 |

### Sealing sleeves

| Dia. mm | Pieces per pack | Price € | Quantity scale from | Scale price € | Item no.     |
|---------|-----------------|---------|---------------------|---------------|--------------|
| 25      | 3               | 23.20   | 10                  | 20.85         | 5317-0011 N4 |
| 50      | 3               | 30.25   | 10                  | 27.30         | 5317-0010 N4 |

### Quali-Paper

| L x W cm | Pieces per pack | Price € | Quantity scale from | Scale price € | Item no.     |
|----------|-----------------|---------|---------------------|---------------|--------------|
| 100 x 23 | 50              | 29.95   | 10                  | 27.40         | 5317-0001 N4 |

### Cleaning brushes

| Dia. mm | Length cm | Material            | Price € | Quantity scale from | Scale price € | Item no.     |
|---------|-----------|---------------------|---------|---------------------|---------------|--------------|
| 25      | 40        | PVC/stainless steel | 38.15   | 10                  | 36.10         | 5304-0040 N4 |
| 25      | 60        | PVC/stainless steel | 38.15   | 10                  | 36.10         | 5304-0060 N4 |
| 25      | 80        | PVC/stainless steel | 38.15   | 10                  | 36.10         | 5304-0080 N4 |
| 25      | 100       | PVC/stainless steel | 38.15   | 10                  | 36.10         | 5304-0100 N4 |
| 50      | 100       | PVC/stainless steel | 41.85   | 5                   | 37.70         | 5304-5100 N4 |
| 50      | 300       | PVC/stainless steel | 85.20   | 5                   | 76.80         | 5304-5300 N4 |



## Zone sampler Spiralus



- ▶ Representative sample of the container layers.
- ▶ Aluminium, anodised
- ▶ Tip PA
- ▶ 38 mm Ø
- ▶ Low weight

Zone sampler Spiralus guarantees precise zone sampling through all layers of the sample. The spiral arrangement of the sampling slits means that these are opened one after the other from bottom to top. In this way the lowest opening is filled first and then those above it in sequence until the complete Spiralus has been filled. The shape of the sampling slits prevents seeds from being cut up. The zone sampler Spiralus provides an excellent all-layer sample.

### Applications

Spiralus is particularly suitable for sampling coarse-grained bulk goods, seeds and pellets at locations such as soil heaps, warehouses, trucks, railway goods wagons, etc.

| Zone sampler Spiralus                       |                 |              |                   |         |              |  |  |
|---|-----------------|--------------|-------------------|---------|--------------|--|--|
| Total length cm                             | No. of openings | Weight g     | Chamber volume ml | Price € | Item no.     |  |  |
| 145   | 8               | 1400         | 770               | 396.40  | 5318-0145 N4 |  |  |
| 200   | 8               | 2000         | 1100              | 532.20  | 5318-0200 N4 |  |  |
| Accessories                                 |                 |              |                   |         |              |  |  |
| Description                                 | Price €         | Item no.     |                   |         |              |  |  |
| Cleaning brushes 50 mm dia., length 1000 mm | 41.85           | 5304-5100 N4 |                   |         |              |  |  |

## EasySampler | easy to empty



- ▶ Stainless steel V4A (1.4404)
- ▶ For sample opening from 52 mm Ø

It is possible to take multiple samples from bulk goods with this sampler quickly and easily.

Emptying has been greatly simplified and in this model takes place via the tip. The advantage: The sample can be emptied directly into the sample container without having to disassemble the EasySampler, in order to obtain a mixed sample for instance.

The bulk material must be free-flowing or self-flowing.

EasySampler has been developed in cooperation with an international chemical concern based in Ludwigshafen, Germany.

| EasySampler       |                 |           |         |              |  |  |  |
|-------------------|-----------------|-----------|---------|--------------|--|--|--|
| Chamber volume ml | Total length cm | Tube Ø mm | Price € | Item no.     |  |  |  |
| 60                | 100             | 32        | 497.35  | 5360-0600 N2 |  |  |  |
| 200               | 104,5           | 32        | 497.35  | 5360-1000 N2 |  |  |  |

## All-layer drill



The all-layer drill is a special zone collector specifically designed for heavily compacted substances. Often it is very difficult or impossible with conventional zone collectors to penetrate media of this type and take a sample extending through all layers. By contrast, the drilling blades of the all-layer drill burrow easily and quickly to the required depth without expending any great force. This makes it easy to take samples of media, even those with high density, and every type of highly compacted powders and granulates.

The all-layer drill thus allows you to take a representative sample through all the layers, even with greatly compressed media.

It is ideal for larger containers, mixed containers, big bags, etc. in the building materials, chemical, pharmaceutical, food and luxury items industries.

- ▶ Stainless steel V4A (1.4404)
- ▶ 25-mm diameter

### Use

1. The all-layer drill is screwed manually into the bulk material.
2. The chambers are opened at the desired sample depth and the sample material flows in.
3. Close the chambers.
4. Remove or unscrew the all-layer drill.
5. Empty the sample through the open inner tube.



### All-layer drill

| Material | Total length cm | Insertion depth mm | No. of openings | Chamber volume ml | Price € | Item no.     |
|----------|-----------------|--------------------|-----------------|-------------------|---------|--------------|
| V4A      | 150             | 1355               | 5               | 260               | 1092.95 | 5310-0150 N4 |



### Accessories

| Description                                | Price € | Item no.     |
|--|---------|--------------|
| Cleaning brushes 25 mm dia., length 100 cm | 38.15   | 5304-0100 N4 |

## All-layer-scratcher



The scratcher is a special sampler for powders and granules that do not flow freely. The sample is transferred to the closable inner tube using a scraper. Sliding PTFE separators are used to divide the inner tube into different zones. The separators also prevent the sample from being mixed.

- ▶ For caked bulked goods
- ▶ Zones can be varied due to moveable PTFE separators.
- ▶ Made of stainless steel V4A (1.4404) and PTFE



| All-layer-scratcher                        |           |                   |         |              |
|--|-----------|-------------------|---------|--------------|
| Dia. mm                                    | Length mm | Chamber volume ml | Price € | Item no.     |
| 25   | 1000      | 180               | 383.05  | 5351-1000 N2 |
| <b>Accessories</b>                         |           |                   |         |              |
| Description                                | Price €   | Item no.          |         |              |
| Cleaning brushes 25 mm dia., length 100 cm | 38.15     | 5304-0100 N4      |         |              |

## Scratcher | for non-pourable substances



The scratcher has particularly been designed for sampling cohesive, caked and not free-flowing substances.

- ▶ Stainless steel V4A (1.4404)
- ▶ Electro-polished
- ▶ Total length 1000 mm

### Use

1. Insert the closed lance into the sample.
2. Open the inner tube by turning the sample chamber when at the required depth.
3. Turn the scratcher by 360° in the sample, the scraper directs the caked material into the sample chamber.
4. Close the sample chamber.

| Scratcher         |                 |                            |         |              |
|-------------------|-----------------|----------------------------|---------|--------------|
| Chamber volume ml | Flute length mm | Outer dia. with scraper mm | Price € | Item no.     |
| 5                 | 22              | 25                         | 878.30  | 5347-0005 N2 |
| 10                | 45              | 25                         | 919.95  | 5347-0010 N2 |
| 25                | 110             | 25                         | 963.80  | 5347-0025 N2 |

## PowderProof® | mobile powder sampling

Quality assurance starts with the inspection of incoming goods! An all-layer sample of bulk goods is no longer a problem with PowderProof®, the sampler for powders and granules.

PowderProof® is the practically proven professional solution for mobile sampling of powders and granules. Different lances and augers can be attached to the robust drive unit and swapped without any problems. This modular design makes PowderProof® a versatile instrument for sampling powders and granules from drums, barrels, bags or sacks.

Safe and reliable sampling is made even easier with useful accessories such as basket-enclosed bottles, sample bags and close-it control seals.

PowderProof® with lance for horizontal use, such as sampling from sacks, with lance for vertical use, for sampling from open containers such as barrels, drums or bags.



# PowderProof® | mobile powder sampling



- ▶ Many uses
- ▶ Stainless steel V4A (1.4404)
- ▶ Incl. motor, two rechargeable batteries, LED-lamp, fast charger, clip for holding the bag and cleaning brush
- ▶ Additional augers available as accessory

### Use

1. The lance is inserted into the sack/container with the spiral screw rotating.
2. The powder or granules are immediately transported through the lance and filled directly into a sample bag or bottle at the lance outlet.
3. Any excess sample remaining in the lance is returned to the sack by reversing the spiral screw direction.



### PowderProof®

| Model                              | Lance      | Insertion depth mm | Price € | Item no.     |
|------------------------------------|------------|--------------------|---------|--------------|
| for powders up to 2mm dia.         | horizontal | 300                | 1633.20 | 5302-0302 N2 |
| for powders up to 2mm dia.         | vertical   | 600                | 1756.50 | 5302-0602 N2 |
| for powders up to 2mm dia.         | vertical   | 900                | 1839.30 | 5302-0902 N2 |
| for powders up to 2mm dia.         | vertical   | 1200               | 2039.40 | 5302-1202 N2 |
| for granules from 2 up to 4mm dia. | horizontal | 300                | 1633.20 | 5302-0301 N2 |
| for granules from 2 up to 4mm dia. | vertical   | 600                | 1756.50 | 5302-0601 N2 |
| for granules from 2 up to 4mm dia. | vertical   | 900                | 1839.30 | 5302-0901 N2 |
| for granules from 2 up to 4mm dia. | vertical   | 1200               | 2039.40 | 5302-1201 N2 |

### Accessories

| Description  | Price € | Item no.     |
|--|---------|--------------|
| Spiral screw PowderProof® for powders up to 2mm dia., for 300 mm       | 239.55  | 5302-0312 N2 |
| Spiral screw for PowderProof® for powders up to 2 mm dia., for 600 mm  | 260.55  | 5302-0612 N2 |
| Spiral screw for PowderProof® for powders up to 2 mm dia., for 900 mm  | 286.45  | 5302-0912 N2 |
| Spiral screw for PowderProof® for powders up to 2 mm dia., for 1200 mm | 308.65  | 5302-1212 N2 |
| Spiral screw for PowderProof® for granules 2 - 4 mm dia., 300 mm       | 239.55  | 5302-0311 N2 |
| Spiral screw for PowderProof® for granules 2 - 4 mm dia., for 600 mm   | 260.55  | 5302-0611 N2 |
| Spiral screw for PowderProof® for granules 2 - 4 mm dia., for 900 mm   | 286.45  | 5302-0911 N2 |
| Spiral screw for PowderProof® for granules 2 - 4 mm dia., for 1200 mm  | 308.65  | 5302-1211 N2 |
| Bag clip for PowderProof®  | 15.25   | 0006-6259 N4 |
| Transport case LxWxH 123x25x11 cm                                      | 95.25   | 3600-2120 N4 |
| Sampling bottle LDPE 500 ml  | 2.72    | 0318-0500 N3 |
| Basket for sample bottles 500 ml, incl. holding ring                   | 75.35   | 5302-2050 N2 |
| Basket for sample bottles 1000 ml, incl. holding ring                  | 92.90   | 5302-2100 N2 |
| Packaging bags with closure, 170x120 mm, 400 ml, 100 pieces            | 9.05    | 2348-0005 N3 |



PowderProof® for horizontal...

... and vertical use

# SiloDrill | for sampling from silo vehicles

- ▶ Drill tip with drilling blades for easy boring



## SiloDrill | for sampling from silo vehicles

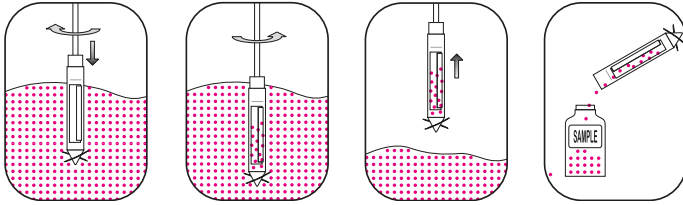

If bulk goods are transported over long distances (in trucks, railway goods wagons), separation may occur.

Taking the sample just from the surface therefore leads to the wrong result.

Representative samples from all layers of the silo can be taken with the SiloDrill. The SiloDrill fits through all standard openings with its diameter of 90 mm.

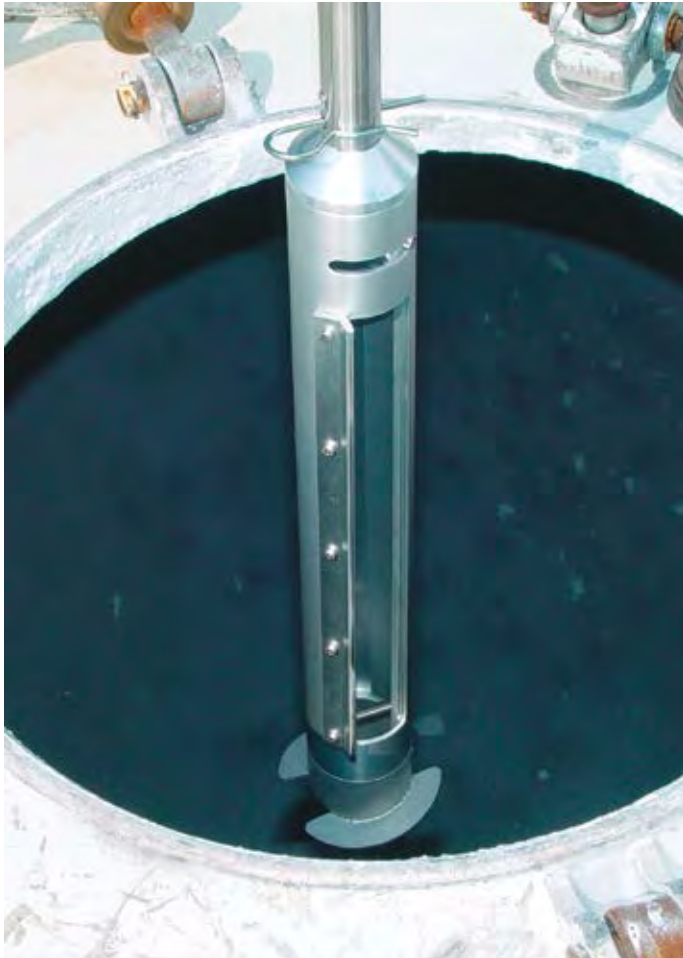

- ▶ Of stainless steel V2A (1.4301) or aluminium
- ▶ Standard length 150 cm, extendable in increments of 100 cm, max. 350 cm
- ▶ Sprung inner tube prevents jamming of coarse grains
- ▶ Scraper edge for cohesive substances
- ▶ Sturdy, removable T-handle
- ▶ Drill tip with drilling blades for easy boring
- ▶ Easy removal of the sample chamber, simple cleaning

### SiloDrill

| Material  | Total length cm | Spiral screw dia. mm | Chamber dia. mm | Volume ml | Price € | Item no.     |
|-----------|-----------------|----------------------|-----------------|-----------|---------|--------------|
| aluminium | 150             | 90                   | 40              | 400       | 468.45  | 5301-1000 N4 |
| V2A       | 150             | 90                   | 40              | 400       | 2564.20 | 5301-2000 N4 |

### Accessories

| Description                       | Price € | Item no.     |
|-----------------------------------|---------|--------------|
| SiloDrill extension V2A, 100 cm   | 100.45  | 5301-0500 N4 |
| Transport case LxWxH 123x25x11 cm | 95.25   | 3600-2120 N4 |

# Silo sampler SiloPicker

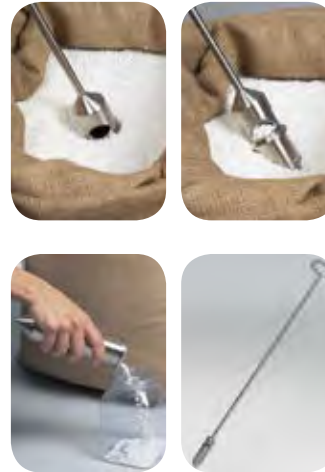

The SiloPicker is ideal for taking bulk goods samples from silos. Using the extension rods, samples can be taken from depths down to 3.5 m.

The insertion depth depends on the density of the bulk goods.

- ▶ Stainless steel V4A (1.4404)

## Use

1. Insert SiloPicker into the bulk goods. When this is done, the closure sleeve automatically closes the collection container.
2. When the sampling depth has been reached, the closure sleeve is opened by gently pulling back the SiloPicker, the sampling container is filled.
3. Pull out the SiloPicker and empty it.

| Silo sampler SiloPicker           |           |               |         |              |  |  |
|-----------------------------------|-----------|---------------|---------|--------------|--|--|
| Chamber volume ml                 | Length cm | Outer dia. mm | Price € | Item no.     |  |  |
| 100                               | 130       | 50            | 353.15  | 5340-1100 N4 |  |  |
| Accessories                       |           |               |         |              |  |  |
| Description                       |           |               | Price € | Item no.     |  |  |
| SiloPicker extension 50 cm        |           |               | 48.50   | 5380-0508 N4 |  |  |
| SiloPicker extension 100 cm       |           |               | 56.40   | 5380-1008 N4 |  |  |
| SiloPicker handle                 |           |               | 57.25   | 0006-8112 N4 |  |  |
| SiloPicker sample container       |           |               | 238.40  | 5340-0100 N4 |  |  |
| Transport case LxWxH 123x25x11 cm |           |               | 95.25   | 3600-2120 N4 |  |  |

## Unit-Dose-Sampling

During powder separation checks and purity validations of powders, liquids and semi-solid substances, special procedures (unit-dose-sampling) must be employed to achieve the desired results.

Special sampling methods, which are required especially in the pharmaceutical industry in conformance with FDA and GMP specifications, require samplers with special features.

- ▶ High degree of preciseness
- ▶ Groove-free surfaces, electro-polished if possible
- ▶ AISI 316 stainless steel or PTFE materials
- ▶ Sterilisable
- ▶ Easy and perfect cleaning

Many Bürkle Samplers fulfill these demands, have been tested in actual practice, and are distinguished by especially sturdy and precise machining.

**Novartis** is a pharma zone sampler for unit-dose sampling:

- ▶ For various sampling depths with simultaneous double sample (Duo-Sampler).
- ▶ Precise volume calibration with 40 exchangeable sample inserts with volumes from 0.1 ml to 4.0 ml, in increments of 0.1 ml.



# Novartos | pharma zone sampler for sampling according to FDA guidelines for unit-dose sampling

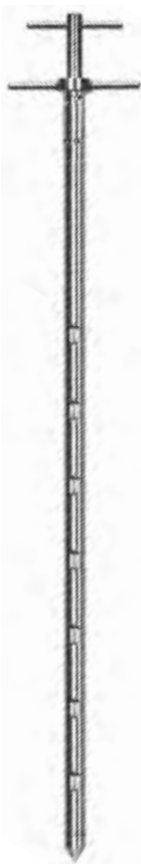

The Novartos Multi has 14 sample chambers for up to seven sample zones for an all-layer sample.

Novartos was developed on cooperation with a globally-operating pharmaceuticals and chemicals corporation located in Basel, Switzerland.

- ▶ The sample inserts fit precisely and can easily be replaced.
- ▶ Inserts are available in volumes from 0 to 4.0 ml
- ▶ The insertion depths can easily be read from the laser-engraved depth scale
- ▶ Stainless steel V4A (1.4404 / 1.4571)
- ▶ Groove-free and hand-polished
- ▶ 25 mm Ø



Novartos Uno sampler with two sample chambers, for one sample zone.



Novartos double-sample



**!** Please order inserts separately!

Novartos the Pharma zone sampler for sampling according to FDA guidelines for Unit-Dose-Sampling. It is now possible to withdraw a double-sample without inserting the lance repeatedly into the bulk material. Mixing is mainly prevented in this way.

One significant advantage of Novartos is the easy cleaning.

Complete filling and emptying of sample chambers has been improved substantially using computer-optimised geometry. There are no crevices or dead spaces where sampling residues can collect.

- Novartos Uno for targeted sampling
- Novartos Multi enables all-layer samples

| Novartos Multi                    |           |              |              |
|-----------------------------------|-----------|--------------|--------------|
| Model                             | Length mm | Price €      | Item no.     |
| without inserts                   | 1000      | 1651.25      | 5358-1000 N4 |
| <b>Accessories</b>                |           |              |              |
| Description                       | Price €   | Item no.     |              |
| Transport case LxWxH 123x25x11 cm | 95.25     | 3600-2120 N4 |              |

| Novartos Uno  |           |              |              |
|---|-----------|--------------|--------------|
| Model   | Length mm | Price €      | Item no.     |
| without inserts   | 600       | 1073.75      | 5358-0600 N4 |
| without inserts   | 1000      | 1123.50      | 5358-1001 N4 |
| without inserts   | 1400      | 1149.85      | 5358-1400 N4 |
| <b>Accessories</b>  |           |              |              |
| Description   | Price €   | Item no.     |              |
| Transport case LxWxH 123x25x11 cm (not for Novartos 1400mm) | 95.25     | 3600-2120 N4 |              |

| Accessories                                 |         |              |  |
|---|---------|--------------|--|
| Description                                 | Price € | Item no.     |  |
| Inserts for Novartos Multi capacity 0,0 ml  | 84.65   | 5358-0000 N4 |  |
| Inserts for Novartos Multi, capacity 0,5 ml | 98.29   | 5358-0005 N4 |  |
| Inserts for Novartos Multi, capacity 1 ml   | 98.29   | 5358-0010 N4 |  |
| Inserts for Novartos Multi, capacity 1,5 ml | 98.29   | 5358-0015 N4 |  |
| Inserts for Novartos Multi, capacity 2 ml   | 98.29   | 5358-0020 N4 |  |
| Inserts for Novartos Uno, capacity 0 ml     | 84.65   | 5358-0100 N4 |  |
| Inserts for Novartos Uno, capacity 0,5 ml   | 98.29   | 5358-0105 N4 |  |
| Inserts for Novartos Uno, capacity 1 ml     | 98.29   | 5358-0110 N4 |  |
| Inserts for Novartos Uno, capacity 2 ml     | 98.29   | 5358-0120 N4 |  |
| Inserts for Novartos Uno, capacity 3 ml     | 98.29   | 5358-0130 N4 |  |
| Inserts for Novartos Uno, capacity 4 ml     | 98.29   | 5358-0140 N4 |  |

# MicroSampler | useful for taking small samples, sterilisable



The MicroSampler has especially been designed for the sampling of small quantities of powder.

Volumes of 0.2 ml, 0.5 ml, 1.0 ml, 2.0 ml, 5.0 ml and 10 ml can be sampled easily, quickly and cleanly from different sampling depths from sacks or containers.

The tips of the MicroSampler are interchangeable. This means that tips with different volumes can be used.

- ▶ Point sampling
- ▶ Various lengths and volumes are available
- ▶ Tip can be removed, easy cleaning
- ▶ Stainless steel V4A (1.4404)
- ▶ Sterilisable
- ▶ Additional tips are available in different sizes

Please order lance and head separately!

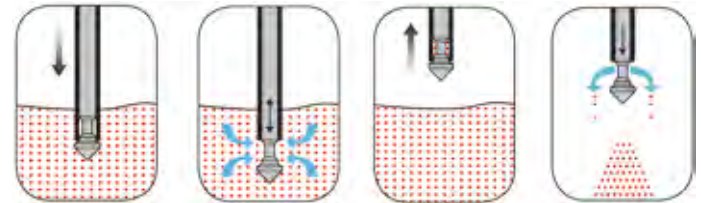

## Use

1. Insert MicroSampler into powder.
2. At the predetermined point, open the volume tip by pressing the button, the sample flows in.
3. Close the volume tip, the sample is collected.
4. Pull back the lance, open the volume tip again, empty the sample.



## MicroSampler

| Tube Ø mm | Length cm | Model        | Price € | Item no.     |
|-----------|-----------|--------------|---------|--------------|
| 12        | 55        | without head | 213.55  | 5307-1055 N4 |
| 12        | 85        | without head | 237.05  | 5307-1085 N4 |
| 12        | 120       | without head | 258.00  | 5307-1120 N4 |
| 25        | 55        | without head | 277.75  | 5307-2055 N4 |
| 25        | 85        | without head | 300.05  | 5307-2085 N4 |
| 25        | 120       | without head | 319.75  | 5307-2120 N4 |

## Accessories

| Description   | Price € | Item no.     |
|---|---------|--------------|
| MicroSampler heads fits tube with 12 mm dia., capacity 0,2 ml | 64.30   | 5307-0102 N4 |
| MicroSampler heads fits tube with 12 mm dia., capacity 0,5 ml | 64.30   | 5307-0105 N4 |
| MicroSampler heads fits tube with 12 mm dia., capacity 1ml    | 64.30   | 5307-0110 N4 |
| MicroSampler heads fits tube with 25 mm dia., capacity 2 ml   | 87.70   | 5307-0202 N4 |
| MicroSampler heads fits tube with 25 mm dia., capacity 5 ml   | 87.70   | 5307-0205 N4 |
| MicroSampler heads fits tube with 25 mm dia., capacity 10 ml  | 87.70   | 5307-0210 N4 |

# PharmaPicker | for sampling very small quantities



For sampling very small quantities of highly potent, expensive or active powders for analysis. The smallest sample quantities from 0.1 ml to 2.5 ml can be collected with the PharmaPicker. By simply exchanging the volume tip in the collection cylinder for 0.1 - 1.2 ml or 1.25 - 2.5 ml, the sampling volume is modified.

The PharmaPicker has a length of 60 cm and can be extended repeatedly by 50 cm or 100 cm, maximum length 3.50 m. The PharmaPicker is available separately or as PharmaPicker Case in a handy transport box.

**PharmaPicker Case** consisting of: Collection cylinders in both sizes, extension rod 50 cm and 100 cm, handle, volume tips 0.4 ml, 0.6 ml, 0.8 ml, 1.0 ml, 1.2 ml, 1.4 ml, 1.8 ml, 2.0 ml, 2.3 ml and 2.5 ml (alternative sample volumes on request), transport box.

## Use

1. Insert the required volume tip into the collection cylinder.
2. Insert the PharmaPicker, the disk sleeve closes the collection cylinder automatically.
3. The disk sleeve opens the collection cylinder at the required point, and the desired sample is collected.
4. Withdraw the PharmaPicker completely.
5. Empty the sample directly from the collection cylinder into the analysis container.

- ▶ Stainless steel V4A
- ▶ Electro-polished

Please order lance and head separately!

| PharmaPicker  |                            |
|---|----------------------------|
| Model   | Price €    Item no.        |
| with collection cylinder for 0.10 - 1.20 ml, without head | 332.15    5346-1000    N2  |
| with collection cylinder for 1.25 - 2.50 ml, without head | 332.15    5346-2000    N2  |
| Case, completely  | 1619.65    5346-0010    N2 |

## Accessories

| Description                                     | Price € | Item no.        |
|---|---------|-----------------|
| Volume heads for PharmaPicker, capacity 0,10 ml | 65.55   | 5346-1010    N2 |
| Volume heads for PharmaPicker, capacity 0,20 ml | 65.55   | 5346-1020    N2 |
| Volume heads for PharmaPicker, capacity 0,60 ml | 65.55   | 5346-1060    N2 |
| Volume heads for PharmaPicker, capacity 1,00 ml | 65.55   | 5346-1100    N2 |
| Volume heads for PharmaPicker, capacity 2,00 ml | 65.55   | 5346-2200    N2 |
| Volume heads for PharmaPicker, capacity 2,50 ml | 65.55   | 5346-2250    N2 |

## Accessories

| Description   | Price € | Item no.        |
|---|---------|-----------------|
| Extension rod PharmaPicker 500 mm                           | 54.35   | 5380-0506    N4 |
| Extension rod PharmaPicker 1000 mm                          | 63.10   | 5380-1006    N4 |
| Collection cylinder for 0,10 - 1,20 ml, without volume head | 214.85  | 5346-1001    N2 |
| Collection cylinder for 1,25 - 2,50 ml, without volume head | 205.00  | 5346-2001    N2 |
| Handle PharmaPicker   | 57.25   | 0006-8113    N3 |

## PharmaSpoon | for ultrapure sampling

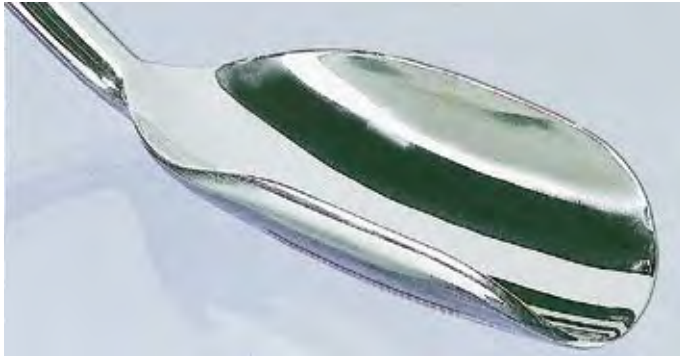

PharmaSpoon for taking samples of powdery substances, intermediate products and material in the pharmaceutical industry. Special materials with excellent surface qualities must be used for this to prevent cross-contamination. Our PharmaSpoon fulfils these requirements. Made of stainless steel V4A (1.4404), surface highly polished by hand (not electro-polished!). The excellent surface properties of the PharmaSpoon provide significant advantages.

- ▶ Possible residues are even visible in the trace sector ( $\mu\text{g}$  sector)
- ▶ The surface is easy to clean
- ▶ The PharmaSpoon is also suitable for sterile sampling

**i** The PharmaSpoon was developed by an internationally known pharmaceutical company in Basel, Switzerland, and its usefulness has been confirmed in actual practice.

### PharmaSpoon

| Total length mm | Price € | Quantity scale from | Scale price € | Item no.     |
|-----------------|---------|---------------------|---------------|--------------|
| 650             | 463.45  | 5                   | 370.75        | 5324-0001 N2 |



## StickProof



Sampler for powder in the pharma area, made of stainless steel V4A, material 1.4404. The especially slender tip can be inserted easily and deeply in order to take the sample. The conical inlet of the tip allows the collection of either very small or larger quantities. StickProof is constructed in one piece without edges, grooves or crevices for perfect and easy cleaning. The sample can be filled directly into the sampling bag from the outlet end. Fasten the bag with a sturdy clamp.

**i** Corresponds to ISTA standard for seed lengths of 10 mm (wheat, oats) and 5 mm (flax, vetches).

- ▶ Surface electro-polished
- ▶ Various sample quantities up to approx. 50 ml
- ▶ Incl. clamp and 100 PE sampling bags 120 x 170 mm

### StickProof

| Length mm | Dia. mm | Price € | Quantity scale from | Scale price € | Item no.     |
|-----------|---------|---------|---------------------|---------------|--------------|
| 410       | 25      | 305.20  | 5                   | 275.45        | 5338-0410 N4 |
| 1100      | 25      | 409.30  | 5                   | 368.50        | 5338-1100 N4 |

### Accessories

| Description   | Price € | Item no.     |
|---|---------|--------------|
| StickProof clamp  | 14.25   | 5338-0001 N2 |
| Packaging bags with closure, 170x120 mm, 400 ml, 100 pieces<br>close-it control seals see page 86 | 9.05    | 2348-0005 N3 |

## Sampling lance Milky | acc. to EN ISO 707



Universal powder and granules sampler made of stainless steel V4A. Developed initially for milk powder samples, conforms to standards of DIN and IDF (International Dairy Federation). The collector is inserted into bags or casks and the sample is removed using a semi-circular profile lance.



- ▶ Stainless steel V4A (1.4404)
- ▶ Insertion depth 385 mm
- ▶ Total length 480 mm
- ▶ Outer diameter approx. 28 mm

close-it seals and close-it food & pharma lock seals ensure non-leak closure of the insertion point in bags and BigBags. See page 86.

| Volume ml | Price € | Quantity scale from | Scale price € | Item no.     |
|-----------|---------|---------------------|---------------|--------------|
| 150       | 154.40  | 5                   | 137.05        | 5321-0300 N4 |

## Sampler Tubus

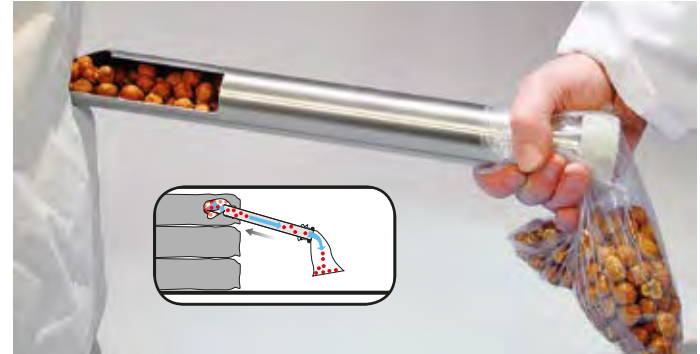

Sampler for pourable bulk goods up to approx. 1 cm in diameter. This makes it possible, for example, to remove hazel nuts, blends of tea, grain or similar items from large sacks.

- ▶ Also for coarse-grained bulk goods
- ▶ Made of stainless steel V4A (1.4404)
- ▶ Special geometry of the tip

**i** Corresponds to ISTA standard for seed lengths of 10 mm (wheat, oats) and 5 mm (flax, vetches).

### Use

1. Insert Tubus into a sack to the desired sampling depth, while keeping the collection tube closed using your hand.
2. When you remove your hand, the sample flows directly through the open tube into the container or sampling bag beneath it.

| Sampler Tubus |         | Price € | Quantity scale from | Scale price € | Item no.     |
|---------------|---------|---------|---------------------|---------------|--------------|
| Length cm     | Dia. mm |         |                     |               |              |
| 40            | 40      | 106.75  | 10                  | 102.57        | 5382-0040 N4 |
| 80            | 40      | 139.09  | 10                  | 126.97        | 5382-0080 N4 |

**Accessories**

Description  
close-it food & pharma control seals see page 88

QuickPicker | collects samples quickly and channels them directly into the sampling bottle

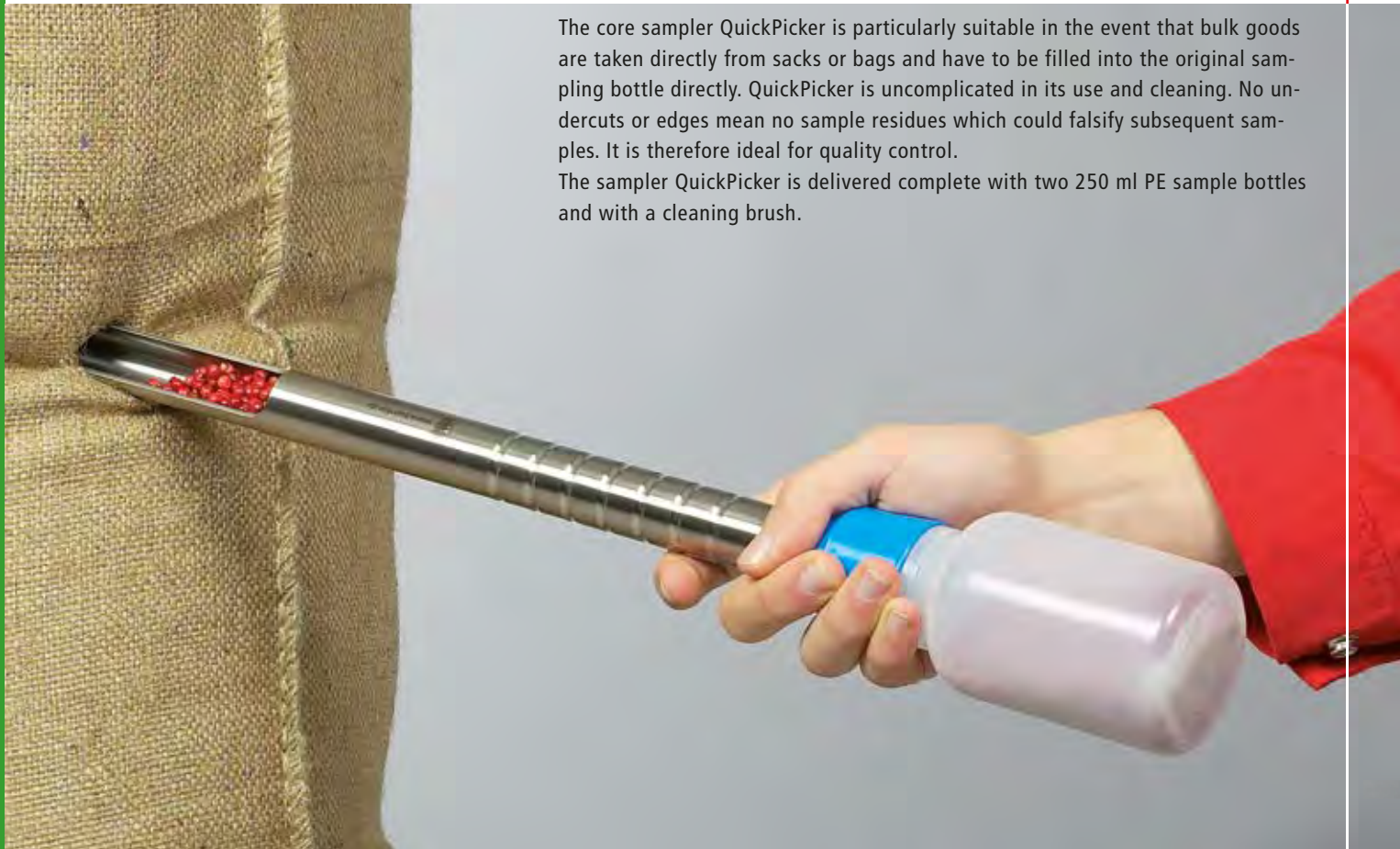

The core sampler QuickPicker is particularly suitable in the event that bulk goods are taken directly from sacks or bags and have to be filled into the original sampling bottle directly. QuickPicker is uncomplicated in its use and cleaning. No undercuts or edges mean no sample residues which could falsify subsequent samples. It is therefore ideal for quality control.

The sampler QuickPicker is delivered complete with two 250 ml PE sample bottles and with a cleaning brush.

# QuickPicker | collects samples quickly and channels them directly into the sampling bottle

- ▶ Insertion depth 30 cm, diameter 25 mm
- ▶ Made of stainless steel (1.4404) approved for use with food-stuffs or PP transparent for aggressive chemicals, scratchproof, sterilisable, cost-effective
- ▶ Removable tip, easy cleaning
- ▶ Additional sampling bottles made of PE or PP available as accessories



QuickPicker V4A in use

**i** Corresponds to ISTA standard for seed lengths of 10 mm (wheat, oats) and 5 mm (flax, wetches).



close-it seals and close-it food & pharma lock seals ensure non-leak closure of the insertion point in bags and BigBags. See page 86.

## QuickPicker

| Material        | Insertion depth mm | Total length cm | Volume ml | Price € | Quantity scale from | Scale price € | Item no.     |
|-----------------|--------------------|-----------------|-----------|---------|---------------------|---------------|--------------|
| V4A             | 300                | 50              | 75        | 196.90  | 5                   | 178.05        | 5322-1300 N4 |
| PP, transparent | 300                | 50              | 75        | 123.85  | 5                   | 112.10        | 5322-0300 N4 |



## Accessories

### Description

| Description                    | Price € | Item no.     |
|--------------------------------|---------|--------------|
| Sampling bottle LDPE, 250 ml   | 1.67    | 0318-0250 N3 |
| Sampling bottle PP, 250 ml     | 1.87    | 0319-0250 N3 |
| Transport case for QuickPicker | 25.80   | 3600-3000 N3 |

close-it control seals see page 86

## close-it control seal | essential for sampling

- ▶ close-it – standard size 95 x 95 mm
- ▶ close-it Maxi - 150 x 150 mm, for larger holes or longer tears in containers
- ▶ The labels are supplied in handy rolls
- ▶ The cross perforations allow each label to be separated from the roll individually





## close-it control seal | essential for sampling

Taking samples from sacks, boxes, bags, etc. with sampling lances is a common and time-proven practice. This produces holes through which easily flowing bulk goods could escape from the container. With the close-it seal, this can be prevented in an uncomplicated manner.

close-it has been especially developed for this purpose. The label has a sandwich-type structure (aluminium/ paper) and seals the container hermetically (vapour barrier). This virtually prevents hygroscopic powders from clumping together. The label is not just used to provide a hermetic seal. It is also used for providing quality control information (sampling date, release yes/no, name of tester, etc.). The labels are available in different colours. With printing in red, blue, green, yellow, black, neutral, without printing in white.

close-it can be written on with ball-point pen, pencil or felt-tip marker.

The rear of the label is coated with a powerful adhesive. This means that close-it sticks firmly

to most commercial containers, even to surfaces coated with fine powder, slightly moist or even frozen surfaces where conventional labels or adhesive tape will not stick.

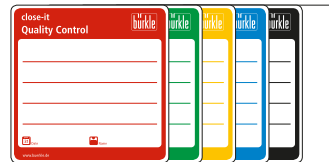

### Control seal close-it 95x95

| Colour | Model     | W x H mm | Pieces per roll | Price € | Quantity scale from | Scale price € | Item no.     |
|--------|-----------|----------|-----------------|---------|---------------------|---------------|--------------|
| red    | printed   | 95 x 95  | 500             | 57.05   | 10                  | 51.00         | 5303-0012 N4 |
| yellow | printed   | 95 x 95  | 500             | 57.05   | 10                  | 51.00         | 5303-0014 N4 |
| blue   | printed   | 95 x 95  | 500             | 57.05   | 10                  | 51.00         | 5303-0015 N4 |
| green  | printed   | 95 x 95  | 500             | 57.05   | 10                  | 51.00         | 5303-0016 N4 |
| black  | printed   | 95 x 95  | 500             | 57.05   | 10                  | 51.00         | 5303-0011 N4 |
| white  | unprinted | 95 x 95  | 500             | 57.05   | 10                  | 51.00         | 5303-0002 N4 |

#### Accessories

| Description                                   | Price € | Item no.     |
|---|---------|--------------|
| close-it dispenser for labels with 95 x 95 mm | 81.10   | 5303-9000 N4 |

### Control seal close-it maxi 150x150

| Colour | Model     | W x H mm  | Pieces per roll | Price € | Quantity scale from | Scale price € | Item no.     |
|--------|-----------|-----------|-----------------|---------|---------------------|---------------|--------------|
| red    | printed   | 150 x 150 | 250             | 79.95   | 10                  | 74.55         | 5303-1012 N4 |
| yellow | printed   | 150 x 150 | 250             | 79.95   | 10                  | 74.55         | 5303-1014 N4 |
| blue   | printed   | 150 x 150 | 250             | 79.95   | 10                  | 74.55         | 5303-1015 N4 |
| green  | printed   | 150 x 150 | 250             | 79.95   | 10                  | 74.55         | 5303-1016 N4 |
| black  | printed   | 150 x 150 | 250             | 79.95   | 10                  | 74.55         | 5303-1011 N4 |
| white  | unprinted | 150 x 150 | 250             | 79.95   | 10                  | 74.55         | 5303-1002 N4 |

#### Accessories

| Description                                     | Price € | Item no.     |
|---|---------|--------------|
| close-it dispenser for labels with 150 x 150 mm | 113.75  | 5303-9100 N4 |

## Control seal close-it food & pharma

In response to numerous requests from our customers, we have developed close-it food & pharma, a control seal with an adhesive approved for use with foodstuffs. The strength of the adhesive is almost as powerful as that of the original, the close-it from Bürkle, proven millions of times. close-it food & pharma also reliably prevents products from leaking out after sampling.

The adhesive complies with the European guidelines for foodstuffs. Just like the original, close-it food & pharma has a barrier layer of aluminium foil. This means that close-it food & pharma is suitable for sampling foodstuffs, pharmaceuticals, cosmetics, food additives, even frozen goods – in short, for all applications in which cleanliness is particularly important.

- ▶ According to FDA Guidelines
- ▶ Particularly suited for the food and pharma industry



### Control seal close-it food & pharma 95x95

| Colour | Model     | W x H mm | Pieces per roll | Price € | Quantity scale from | Scale price € | Item no.     |
|--------|-----------|----------|-----------------|---------|---------------------|---------------|--------------|
| red    | printed   | 95 x 95  | 500             | 57.05   | 10                  | 51.00         | 5303-2017 N4 |
| yellow | printed   | 95 x 95  | 500             | 57.05   | 10                  | 51.00         | 5303-2020 N4 |
| blue   | printed   | 95 x 95  | 500             | 57.05   | 10                  | 51.00         | 5303-2021 N4 |
| green  | printed   | 95 x 95  | 500             | 57.05   | 10                  | 51.00         | 5303-2022 N4 |
| black  | printed   | 95 x 95  | 500             | 57.05   | 10                  | 51.00         | 5303-2023 N4 |
| white  | unprinted | 95 x 95  | 500             | 57.05   | 10                  | 51.00         | 5303-2018 N4 |

#### Accessories

| Description                                   | Price € | Item no.     |
|---|---------|--------------|
| close-it dispenser for labels with 95 x 95 mm | 81.10   | 5303-9000 N4 |

### Control seal close-it food & pharma Maxi 150x150

| Colour | Model     | W x H mm  | Pieces per roll | Price € | Quantity scale from | Scale price € | Item no.     |
|--------|-----------|-----------|-----------------|---------|---------------------|---------------|--------------|
| red    | printed   | 150 x 150 | 250             | 79.95   | 10                  | 74.55         | 5303-3017 N4 |
| yellow | printed   | 150 x 150 | 250             | 79.95   | 10                  | 74.55         | 5303-3020 N4 |
| blue   | printed   | 150 x 150 | 250             | 79.95   | 10                  | 74.55         | 5303-3021 N4 |
| green  | printed   | 150 x 150 | 250             | 79.95   | 10                  | 74.55         | 5303-3022 N4 |
| black  | printed   | 150 x 150 | 250             | 79.95   | 10                  | 74.55         | 5303-3023 N4 |
| white  | unprinted | 150 x 150 | 250             | 79.95   | 10                  | 74.55         | 5303-3018 N4 |

#### Accessories

| Description                                     | Price € | Item no.     |
|---|---------|--------------|
| close-it dispenser for labels with 150 x 150 mm | 113.75  | 5303-9100 N4 |





Besides the individually detachable close-it and close-it food & pharma closure labels, our repeatedly tested and proven control seal is now also available on a continuous roller. This helps you discover whether you require only a small piece, for example for closing a small hole, or for marking a specific point. Or whether you want to repair a long crack or a large hole quickly, reliably and easily.

With its extremely strong adhesive strength, close-it tape holds on the most diverse bases, where the glue effect of normal adhesive tape quickly reaches its maximum capacity.

For universal use, we have kept the adhesive tape close-it tape in white with tear-off lines. It can be labelled with permanent ink and locks gas-proof. Available in the classic close-it design, as well as close-it tape food & pharma, with a food-compatible adhesive.

- ▶ Customizable
- ▶ Different designs
- ▶ For larger holes or longer tears in containers

close-it tape

| Width mm | Model         | Length m | Price € | Quantity scale from | Scale price € | Item no.     |
|----------|---------------|----------|---------|---------------------|---------------|--------------|
| 95       | standard      | 50       | 57.05   | 10                  | 51.00         | 5303-0017 N4 |
| 150      | standard      | 50       | 79.95   | 10                  | 74.55         | 5303-1017 N4 |
| 95       | food & pharma | 50       | 57.05   | 10                  | 51.00         | 5303-2019 N4 |
| 150      | food & pharma | 50       | 79.95   | 10                  | 74.55         | 5303-3019 N4 |

Accessories

| Description                                     | Price € | Item no.     |
|---|---------|--------------|
| close-it dispenser for labels with 95 x 95 mm   | 81.10   | 5303-9000 N4 |
| close-it dispenser for labels with 150 x 150 mm | 113.75  | 5303-9100 N4 |

## close-it | with individual customer-specific special printing

Custom-made according to the customer's specifications

The close-it control seal has many satisfied users who use close-it as a control seal, for documentation or as an informative label.

### Your individual close-it

We would be happy to help you design your own close-it. Do you need final artwork for your draft? Or would you like to use our complete graphics service from draft stage through the print process? Our advertising department would be happy to consider any challenge!

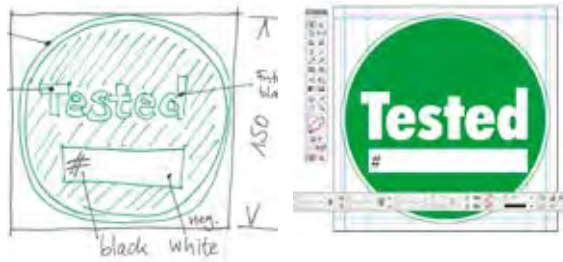

Your idea

Our draft



Finishing and print

Your close-it label

### Shape and colour

Round, square, rectangular or other shape? Unusual contours can also be implemented! We would be pleased to provide you with a quote. Of course print is available in all colours, with either single or multiple colours.

### Finishing

close-it can be manufactured with or without carrier paper perforations. Different numbers of close-it labels can be supplied in a single roll.

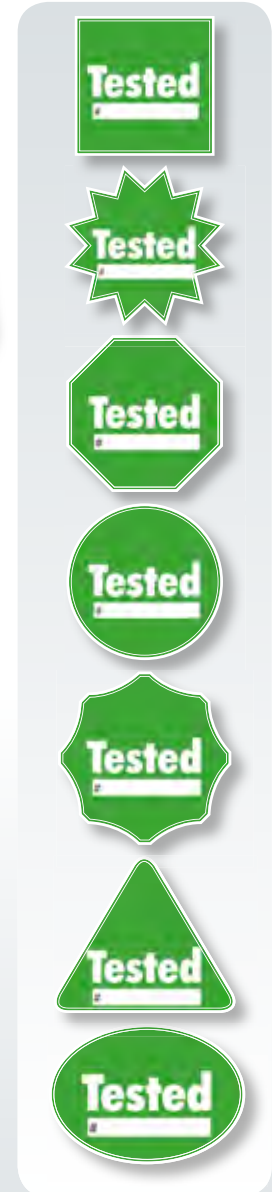

# seal-it security seal | for retention samples and tamper-proof packs close-it dispenser

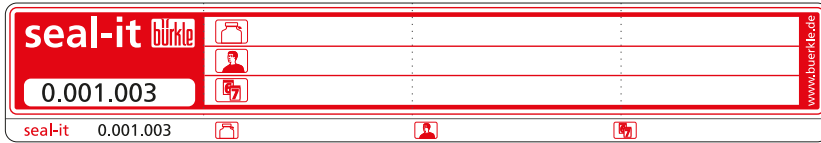

Retention samples are kept to provide a sample for comparison at a later date. The unambiguous proof that the retention sample is identical to the original sample is only possible with clearly marked and sealed containers. However, sealing is frequently not possible unless eyelets are present. seal-it provides the solution! The seal-it self-adhesive label sticks to all conventional containers. Thanks to its unbelievable adhesive power it cannot be removed.

If a container opening is closed with seal-it, then the container cannot be opened without destroying the seal-it label. seal-it is additionally provided with several cross-perforations which immediately tear when manipulated like a motorcar tax disc.

seal-it can be used to securely seal bottles, sample bags, sacks, specimen bags, envelopes, etc. – in principle any type of container. The aluminium foil adapts seal-it to any container shape. The white labelling field on seal-it can be written on with all conventional writing tools with, for example, contents information, sampling date, name of operator, etc.

- ▶ Clear identification via numbers in sequence
- ▶ Integrated control label with the same number, for accompanying documents
- ▶ Format 178 mm long, 30 mm wide
- ▶ Tear-off perforation for each label

## seal-it security seal

| Length mm | Width mm | Colour | Pieces per roll | Price € | Quantity scale from | Scale price € | Item no.     |
|-----------|----------|--------|-----------------|---------|---------------------|---------------|--------------|
| 178       | 30       | red    | 500             | 119.00  | 5                   | 114.60        | 5399-0003 N4 |



The close-it dispenser ensures safe storage and simple removal of the labels. The labels can be conveniently written on due to the marking plate.

- ▶ For close-it standard size 95 x 95 mm or close-it Maxi 150 x 150 mm

## close-it dispenser

| Model                        | Price € | Item no.     |
|------------------------------|---------|--------------|
| for labels with 95 x 95 mm   | 81.10   | 5303-9000 N4 |
| for labels with 150 x 150 mm | 113.75  | 5303-9100 N4 |

## Tamper proof labels safe-it and secure-it

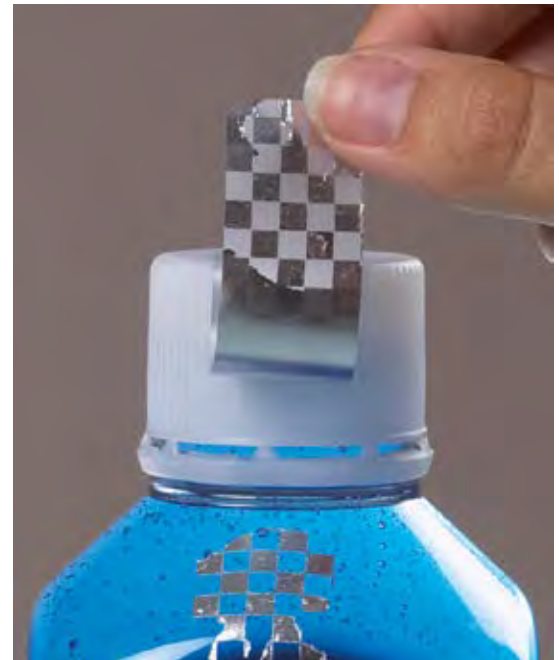

The safety labels safe-it and secure-it are used as originality seals and as protection from manipulations of e.g. samples, retention samples, for transporting samples, sealing containers with important or dangerous chemicals in the lab as well as sealing letters, shipments and much more.

The initial opening of a package is made obvious and irrevocably visible with the seal guaranteeing originality, unauthorised opening can therefore be proven.

If the safety label is removed, it divides into separate layers. A pattern that was previously hidden appears on the surface and is irreversible. The glue leaves a residue on the surface that cannot be removed (a so-called void label). Once the label has been removed, it cannot be used again. Changing the label or modifying it afterwards are therefore not possible.

When the safe-it security seal has been broken, a silver checkerboard pattern appears on both the subsurface and surface of the sticker itself.

- ▶ With checkerboard pattern
- ▶ Visible proof of tampering

### Tamper proof labels safe-it

| W x H mm | Pieces per roll | Price € | Quantity scale from | Scale price € | Item no.     |
|----------|-----------------|---------|---------------------|---------------|--------------|
| 95 x 20  | 500             | 92.45   | 5                   | 83.10         | 5303-5000 N4 |

### Accessories

| Description                                   | Price € | Item no.     |
|---|---------|--------------|
| close-it dispenser for labels with 95 x 95 mm | 81.10   | 5303-9000 N4 |

## Tamper proof labels secure-it



When the secure-it security label has been broken, a bright purple stop sign pattern appears on both the subsurface and surface of the sticker itself. A labeling field is available for comments and notes.

- ▶ With labeling field
- ▶ With stop sign pattern
- ▶ Visible proof of tampering

### Tamper proof labels secure-it

| W x H mm | Pieces per roll | Price € | Quantity scale from | Scale price € | Item no.     |
|----------|-----------------|---------|---------------------|---------------|--------------|
| 95 x 20  | 500             | 139.30  | 5                   | 125.45        | 5303-5010 N4 |

### Accessories

| Description                                   | Price € | Item no.     |
|---|---------|--------------|
| close-it dispenser for labels with 95 x 95 mm | 81.10   | 5303-9000 N4 |

## SampleSafe seal | secure your samples



Retained samples must be always secured against falsification and ambiguity in identification. Bottles with sealing eyelets should therefore be secured with SampleSafe seals.

The seals are made of stable polypropylene. The seals are to be uniquely identified with the serial 9-digit number.

The seal ring has a diameter of 2 mm, therefore SampleSafe seals also fit through small eyelets and slits. The seal tape is secured in the closure chamber by a metal insert made of stainless spring steel. The one-way tightening mechanism offers additional security against manipulation. It is not possible to forcibly open or manipulate the closure of the seal without leaving behind clear traces.

- ▶ Clear identification via numbers in sequence
- ▶ 100 seals (10 strips) per pack.
- ▶ Protection against manipulation by stainless steel safety spring.

### SampleSafe seal

| Length mm | Dia. mm | Colour | Pieces per pack | Price € | Quantity scale from | Scale price € | Item no.     |
|-----------|---------|--------|-----------------|---------|---------------------|---------------|--------------|
| 260       | 2       | red    | 100             | 70.55   | 10                  | 66.80         | 5399-2902 N2 |



## Pigment lance



Pigment lance to sample pigments, pastes and agglomerating bulk goods.

- ▶ With half-open flute 50 %, for heavily sticking products
- ▶ With quarter-open flute 25 %, for lightly sticking products
- ▶ Stainless steel V4A (1.4404)
- ▶ 30 mm Ø

### Use

1. Insert the lance to the required depth.
2. Turn the handle, the sample is collected into the open flute.
3. Pull back the lance.
4. Take out the sample.

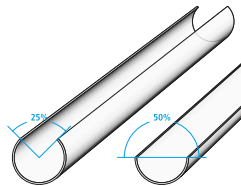

| Pigment lance   |                  |           |                 |         |              |
|-----------------|------------------|-----------|-----------------|---------|--------------|
| Flute length mm | Flute openings % | Volume ml | Total length mm | Price € | Item no.     |
| 300             | 25               | 145       | 432             | 179.05  | 5369-0300 N4 |
| 300             | 50               | 85        | 432             | 195.05  | 5369-0310 N4 |
| 600             | 25               | 312       | 732             | 258.00  | 5369-0600 N4 |
| 600             | 50               | 179       | 732             | 280.25  | 5369-0610 N4 |
| 900             | 25               | 480       | 1032            | 347.00  | 5369-0900 N4 |
| 900             | 50               | 273       | 1032            | 375.45  | 5369-0910 N4 |

## Valve lance

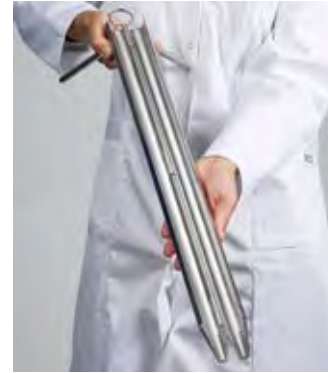

Sampler for all-layer samples of viscous, paste-like, semi-liquid substances, according to DIN 51750 pt. 3 and DIN EN ISO 15528. Different layers remain intact particularly with paste-like substances.

- ▶ Stainless steel V4A (1.4404)
- ▶ 32 mm Ø
- ▶ Optimised opening mechanism (can be completely disassembled) for easy cleaning

### Use

#### For viscous substances:

1. The valve lance is inserted all the way to the bottom, whilst being closed.
2. It is opened, closed and pulled out again.

#### For paste-like substances:

1. The valve lance is inserted all the way to the bottom, whilst being open.
2. It is closed and pulled out again.

| Valve lance                       |         |           |    |
|-----------------------------------|---------|-----------|----|
| Length mm                         | Price € | Item no.  |    |
| 550                               | 1169.20 | 5359-1600 | N4 |
| 800                               | 1461.15 | 5359-1800 | N4 |
| Accessories                       |         |           |    |
| Description                       | Price € | Item no.  |    |
| Transport case LxWxH 123x25x11 cm | 95.25   | 3600-2120 | N4 |



## QualiRod conical



Conical hand-drill, conically shaped, with sharp cutting edges and a solid handle. Ideal for cutting out samples for quality control from soft, paste-like substances (cheese, butter, clay, soap, wax, etc.).

- ▶ Stainless steel V2A (1.4301)
- ▶ Sterilisable
- ▶ According to EN/ISO 707

| QualiRod conical                                 |         |                     |               |           |    |
|--|---------|---------------------|---------------|-----------|----|
| Drilling depth mm                                | Price € | Quantity scale from | Scale price € | Item no.  |    |
| 120  | 52.25   | 5                   | 49.10         | 5311-0001 | N4 |
| 170  | 84.10   | 5                   | 80.60         | 5311-0002 | N4 |
| Accessories                                      |         |                     |               |           |    |
| Description                                      | Price € | Item no.            |               |           |    |
| Transport case, inner dimensions 258x178x45 mm   | 11.65   | 3600-0021           | N3            |           |    |
| close-it food & pharma control seals see page 88 |         |                     |               |           |    |

## QualiRod cylindrical



Cylindrical hollow drill with a sharp cutting edge, can easily be driven into paste-like and semi-solid substances. The samples cut out are subsequently removed with the appropriate push-rod ejector. Total length 260 mm. Inner Ø 8 mm, outer Ø 10 mm.

- ▶ Stainless steel V2A (1.4301)
- ▶ Sterilisable
- ▶ Inner Ø 8 mm, outer Ø 10 mm

| QualiRod cylindrical                           |         |                     |               |           |    |
|--|---------|---------------------|---------------|-----------|----|
| Drilling depth mm                              | Price € | Quantity scale from | Scale price € | Item no.  |    |
| 200  | 114.65  | 5                   | 103.65        | 5311-0101 | N4 |
| Accessories                                    |         |                     |               |           |    |
| Description                                    | Price € | Item no.            |               |           |    |
| Transport case, inner dimensions 258x178x45 mm | 11.65   | 3600-0021           | N3            |           |    |

## Spatula



Universal instrument for collecting, dividing and mixing pastes, creams etc.

- ▶ Blade made of stainless steel V2A (1.4301)
- ▶ Wooden handle

| Spatula   |         |                     |               |              |
|-----------|---------|---------------------|---------------|--------------|
| Length mm | Price € | Quantity scale from | Scale price € | Item no.     |
| 180       | 12.55   | 10                  | 11.65         | 5313-0180 N4 |
| 300       | 20.25   | 10                  | 18.35         | 5313-0300 N4 |

## Stainless steel spatula

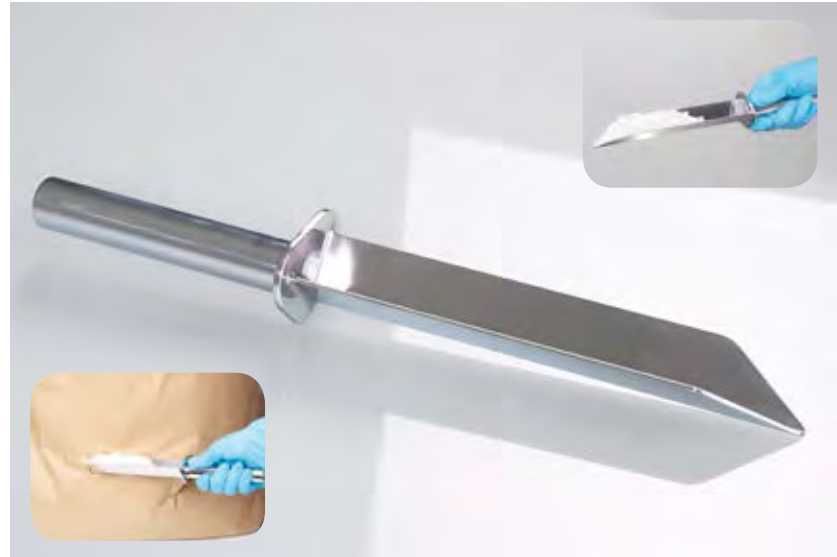

Sample spatula made of stainless steel V4A (1.4404). The highly stable and solid design of the spatula allow it to pierce solid substances or sacks and BigBags. The spatula is made of premium stainless steel, high-gloss polished and completely welded, thus completely free of undercuts. It is therefore ideally suited for taking samples of powders, granulates and pasty media, especially in food and pharmaceutical applications.

- ▶ Made completely of stainless steel V4A (1.4404)
- ▶ Very sturdy
- ▶ Easy to clean
- ▶ Autoclavable
- ▶ Can be flame-sterilized
- ▶ High-gloss polished



| Stainless steel spatula |           |                 |         |                     |               |              |
|-------------------------|-----------|-----------------|---------|---------------------|---------------|--------------|
| Insertion depth mm      | Volume ml | Total length mm | Price € | Quantity scale from | Scale price € | Item no.     |
| 188                     | 50        | 300             | 140.45  | 5                   | 130.80        | 5383-1000 N4 |

## Stainless steel scoop



In contrast to conventional scoops, the stainless steel scoop has no openings, undercuts or crevices in which residues could collect. Pore-free finishing produced by high-quality laser welding seams. The stainless steel scoop can be flame-sterilised and can therefore be made completely germ-free.

- ▶ Scoop made of stainless steel V2A (1.4301), complete with rod
- ▶ Sterilisable by flame sterilisation or steam sterilisation

### Stainless steel scoop

| Total length cm | Capacity ml | Price € | Item no.     |
|-----------------|-------------|---------|--------------|
| 115             | 1000        | 230.35  | 5354-1000 N4 |

## Mini ViscoSampler | for small quantities



Sampler for viscous substances such as pastes, mud, creams, oils. The sample is drawn in using the pump rod and directly conveyed to the sampling container. Easy cleaning for flawless sampling. Depending on the viscosity, the removable suction tip can be fitted with suction drills of 2 mm to 6 mm.

- ▶ Stainless steel V4A (1.4404), seals PTFE
- ▶ Sterilisable
- ▶ Ideal for the pharmaceutical and cosmetics industry
- ▶ Incl. suction tip 2 mm
- ▶ 15 mm Ø

### Mini ViscoSampler

| Length cm | Chamber volume ml | Price € | Quantity scale from | Scale price € | Item no.     |
|-----------|-------------------|---------|---------------------|---------------|--------------|
| 60        | 30                | 244.40  | 5                   | 218.95        | 5341-1060 N4 |
| 100       | 50                | 283.75  | 5                   | 255.80        | 5341-1100 N4 |
| 150       | 75                | 346.90  | 5                   | 316.50        | 5341-1150 N4 |

### Accessories

| Description   | Price € | Item no.     |
|---|---------|--------------|
| Suction heads for Mini ViscoSampler, suction drill 2 mm | 38.00   | 5341-1002 N4 |
| Suction heads for Mini ViscoSampler, suction drill 4 mm | 38.00   | 5341-1004 N4 |
| Suction heads for Mini ViscoSampler, suction drill 6 mm | 38.00   | 5341-1006 N4 |
| Drain safety stand (see page 57)                        | 45.30   | 5618-1000 N4 |

# ViscoSampler | sample collector for medium viscosity substances



ViscoSampler with powerful suction for viscous media. The media is drawn up and discharged using the suction flask. Made of ultra-pure, chemically inert PTFE/FEP for contamination-free sampling.

Specially developed for viscous substances such as slurries, silt, wet clay and soil samples, soil sediments, oils, emulsions, creams etc.

**Colour-coded handles** to prevent mix-up, available as optional accessories.

**Easy cleaning** - all surfaces are poreless and without crevices. Dirt accumulation is prevented. Only round screw threads tried and tested in the field of food hygiene are used. Disassembly and cleaning are extremely simple.



## QualiSampler set

The handy set, which comes complete with carrying case, combines the LiquiSampler and the ViscoSampler with practical accessories.

Models in PP or PTFE/ FEP.

- ▶ QualiSampler set consisting of:
- ▶ LiquiSampler, 100 cm
- ▶ ViscoSampler, 100 cm
- ▶ Case, five bottles, cleaning brush

## ViscoSampler

| Material              | Volume ml | Immersion depth cm | Dia. mm | Price € | Item no.     |
|-----------------------|-----------|--------------------|---------|---------|--------------|
| PP, transparent       | 160       | 60                 | 32      | 225.15  | 5331-1060 N4 |
| PP, transparent       | 300       | 100                | 32      | 265.90  | 5331-1100 N4 |
| PP, transparent       | 650       | 200                | 32      | 394.70  | 5331-1200 N4 |
| PTFE/FEP, transparent | 160       | 60                 | 32      | 302.00  | 5331-2060 N4 |
| PTFE/FEP, transparent | 300       | 100                | 32      | 342.90  | 5331-2100 N4 |
| PTFE/FEP, transparent | 650       | 200                | 32      | 484.85  | 5331-2200 N4 |



## Accessories

| Description  | Price € | Item no.     |
|--|---------|--------------|
| Handles ViscoSampler set in blue, green, yellow, white and black | 42.75   | 5331-0020 N4 |
| Cleaning brushes 25 mm dia., length 100 cm                       | 38.15   | 5304-0100 N4 |
| Drain safety stand (see page 57)                                 | 45.30   | 5618-1000 N4 |

## QualiSampler set

| Material   | Price € | Item no.     |
|------------|---------|--------------|
| PP         | 506.30  | 5330-1000 N4 |
| PTFE / FEP | 711.10  | 5330-1001 N4 |

# LiquiSampler | sample collector for liquids



LiquiSampler for liquids, according to DIN EN ISO 15528. Made of ultra pure and chemically inert PTFE/FEP or PP for contamination-free sampling.

Sampling from open and closed containers, barrels, tanks, silos, water courses. Suitable for all commercially available barrels and containers with opening of at least 32 mm in diameter.

**Push-buttons colour-coded** to prevent mix-up, available as optional accessories.

**Easy cleaning** - all surfaces are free of pores and crevices, preventing accumulation of dirt. Only round screw threads proven in foodstuffs hygiene are used. Disassembly and cleaning are extremely simple.

- ▶ Practical one-handed use at the push of a button
- ▶ With scraping ring for marking of depth and cleaning
- ▶ Transparent
- ▶ Available in PTFE/ FEP or PP transparent
- ▶ Point sampling, all-layer and soil samples possible

## Use

### All-layer sample

1. Slowly insert the LiquiSampler into the liquid with the button pressed.
2. Release the push-button, the valve closes.
3. Withdraw the lance and take out the sample.

### Point sampling/soil sample

1. Insert the LiquiSampler to the targeted point/to the ground with closed valve.
2. Press the button - the liquid flows in.
3. Release the push-button, the valve closes.
4. Pull out the LiquiSampler, take out the sample.



| LiquiSampler  |           |                    |         |         |           |    |  |  |
|---|-----------|--------------------|---------|---------|-----------|----|--|--|
| Material  | Volume ml | Immersion depth cm | Dia. mm | Price € | Item no.  |    |  |  |
| PP, transparent   | 150       | 60                 | 32      | 145.70  | 5330-1060 | N4 |  |  |
| PP, transparent   | 250       | 100                | 32      | 193.90  | 5330-1100 | N4 |  |  |
| PP, transparent   | 500       | 200                | 32      | 290.10  | 5330-1200 | N4 |  |  |
| PTFE/FEP, transparent   | 150       | 60                 | 32      | 225.15  | 5330-2060 | N4 |  |  |
| PTFE/FEP, transparent   | 250       | 100                | 32      | 300.85  | 5330-2100 | N4 |  |  |
| PTFE/FEP, transparent   | 500       | 200                | 32      | 415.20  | 5330-2200 | N4 |  |  |
| Accessories   |           |                    |         |         |           |    |  |  |
| Description   | Price €   | Item no.           |         |         |           |    |  |  |
| Push-buttons for set LiquiSampler in blue, green, yellow, white and black | 25.80     | 5330-0149          | N4      |         |           |    |  |  |
| Cleaning brushes 25 mm dia., length 100 cm                                | 38.15     | 5304-0100          | N4      |         |           |    |  |  |

# Dip Sampler, plunging siphon



Dip sampler for simple removal of liquid samples. Good view due to transparent tubes. Upper end with reflux valve, lower end with ball valve.

- ▶ PP, transparent
- ▶ Dip sampler, item no. 5315-0200, steplessly extendable from 100 cm to 200 cm
- ▶ All-layer and point sampling possible



### Use

#### All-layer sample

1. Insert the dip sampler slowly into the liquid with the valve open.
2. Close valve.
3. Pull the dip sampler back and take out the sample.

#### Point sampling/soil sample

1. Insert the dip sampler to the targeted point/to the ground with closed valve.
2. Open the valve - the liquid flows in.
3. Close the valve.
4. Pull out the dip sampler, take out the sample.

## Dip Sampler, plunging siphon

| Volume ml | Immersion depth cm | Tube Ø mm | Price € | Quantity scale from | Scale price € | Item no.     |
|-----------|--------------------|-----------|---------|---------------------|---------------|--------------|
| 140       | 50                 | 25        | 41.75   | 5                   | 38.00         | 5315-0050 N4 |
| 280       | 100                | 25        | 44.80   | 5                   | 40.80         | 5315-0100 N4 |
| 500       | 100 - 200          | 25        | 53.85   | 5                   | 48.40         | 5315-0200 N4 |



## Disposable plunging siphon



If strongly adhesive liquids are sampled, it can be a lot less expensive to dispose of the sampler than to carry out a complicated cleaning process. The disposable dip sampler were developed especially for this purpose. They are made of PE, transparent and the contents are easily visible. PE provides a surface that resists adhesion of the sample material, minimising sample retention on the dip sampler.

### Use

1. Insert the dip sampler into the liquid and fill it.
2. Close the thumbhole above the handle using your thumb.
3. Take out the dip sampler and empty the liquid into the sample bottle.

### Disposable plunging siphon

| Volume ml | Immersion depth cm | Total length cm | Tube Ø mm | Price € | Quantity scale from | Scale price € | Item no.  |    |  |  |
|-----------|--------------------|-----------------|-----------|---------|---------------------|---------------|-----------|----|--|--|
| 75        | 35                 | 50              | 27        | 8.65    | 12                  | 7.90          | 5387-0050 | N4 |  |  |
| 175       | 60                 | 75              | 27        | 16.10   | 12                  | 14.20         | 5387-0075 | N4 |  |  |
| 275       | 85                 | 100             | 27        | 22.30   | 12                  | 20.25         | 5387-0100 | N4 |  |  |

## PTFE Scoop



All parts coming into contact with the sample medium are made of pure white PTFE. Completely inert against all substances (with the exception of elementary fluoride). The rod is stabilised with a steel core which is completely encapsulated in PTFE. The 60 cm long rod can be extended to 120 cm by adding another component. The scoop PTFE with 10 ml has a strong rod with a length of 155 mm.

### PTFE Scoop

| Capacity ml | Dia. mm | Height mm | Price € | Item no.  |    |  |  |  |  |
|-------------|---------|-----------|---------|-----------|----|--|--|--|--|
| 10          | 25      | 34        | 49.55   | 5389-0010 | N2 |  |  |  |  |
| 100         | 55      | 65        | 109.65  | 5389-0100 | N2 |  |  |  |  |
| 250         | 70      | 95        | 123.20  | 5389-0250 | N2 |  |  |  |  |
| 500         | 80      | 125       | 150.65  | 5389-0500 | N2 |  |  |  |  |
| 1000        | 105     | 155       | 191.90  | 5389-1000 | N2 |  |  |  |  |

### Accessories

| Description                     | Price € | Item no.     |
|---------------------------------|---------|--------------|
| Extension for PTFE scoop, 60 cm | 86.60   | 5389-0001 N2 |

## Chemistry scoop



Scoop for aggressive liquids, complete with strong handle, entirely made of polypropylene.

- ▶ Rod length 100 cm, Ø 20 mm
- ▶ Without metal parts

| Chemistry scoop  |         |                     |               |              |
|---|---------|---------------------|---------------|--------------|
| Capacity ml   | Price € | Quantity scale from | Scale price € | Item no.     |
| 250   | 56.75   | 10                  | 51.25         | 5353-0250 N4 |
| 600   | 58.75   | 10                  | 52.80         | 5353-0500 N4 |
| 1000  | 60.15   | 10                  | 53.95         | 5353-1000 N4 |

## Stainless steel scoop



In contrast to conventional scoops, the stainless steel scoop has no openings, undercuts or crevices in which residues could collect. Pore-free finishing produced by high-quality laser welding seams.

The stainless steel scoop can be flame-sterilised and can therefore be made completely germ-free.

- ▶ Scoop made of stainless steel V2A (1.4301), complete with rod
- ▶ Sterilisable by flame sterilisation or steam sterilisation

| Stainless steel scoop   |             |         |              |  |
|---|-------------|---------|--------------|--|
| Total length cm   | Capacity ml | Price € | Item no.     |  |
| 115   | 1000        | 230.35  | 5354-1000 N4 |  |



# Liquid-Sampler | single hand operation

Sampler for thin to viscous liquids. Easy use with one-handed operation. With discharge funnel for safe filling of the sample bottles. Material V4A (1.4404).



The valve is opened with the thumb to empty the sample.



The valve is opened by attaching the sample container to empty the sample.



## Liquid-Sampler, open with thumb

| Total length cm | Container dia. mm | Capacity ml | Price € | Quantity scale from | Scale price € | Item no.  |    |
|-----------------|-------------------|-------------|---------|---------------------|---------------|-----------|----|
| 46              | 32                | 50          | 155.20  | 5                   | 151.90        | 5326-0001 | N4 |
| 54              | 32                | 100         | 171.15  | 5                   | 164.50        | 5326-0002 | N4 |

## Liquid-Sampler, place onto bottle

| Container dia. mm | Total length cm | Capacity ml | Price € | Quantity scale from | Scale price € | Item no.  |    |
|-------------------|-----------------|-------------|---------|---------------------|---------------|-----------|----|
| 32                | 45,5            | 50          | 186.35  | 5                   | 168.30        | 5326-0003 | N4 |
| 32                | 53,5            | 100         | 209.00  | 5                   | 190.20        | 5326-0004 | N4 |



② **Angular beaker**  
The beaker is adaptable to different container shapes by adjustable angle setting (up to 90°).

► Polypropylene



③ **Pendulum beaker PP**  
This beaker automatically swings to a horizontal position. Nothing can be spilt. Suitable therefore for deep and narrow shafts (Ø 150 mm).

► Polypropylene



④ **Pendulum beaker stainless steel**  
This beaker automatically swings to a horizontal position. Nothing can be spilt. Suitable therefore for deep and narrow shafts (Ø 130 mm).

► Stainless steel V2A (1.4301)

## ① **Telescopic rod**

Different tools can be attached to the telescopic rod (snap-in joint). The individual rods have been provided with an end stop. This means that one rod cannot accidentally slip out of another rod. The telescopic rods cannot be rotated radially, which means even better handling!

Telescopic rod 5355-0280, extremely short model - yet extendable up to 280 cm. Fits into every car boot!

- Increased telescopic rod rigidity by using cold-rolled profile rod
- Springs made of stainless steel

TeleScoop is a versatile sampling system with exchangeable tools for a wide range of applications. The tools (angular beaker, pendulum beaker, bottle holder, stainless steel beaker and dip net) are attached to the telescopic rod by a practical snap-in joint.

Ideal for sampling from baths, tanks, shafts, open water courses etc. Sampling depths down to 6 m can be reached with the adjustable telescopic aluminum rod.

- For industry and water treatment

# TeleScoop | for industry and water treatment



**⑤ Bottle holder**  
Holds all bottles up to 88 mm Ø. Plastic, glass or metal bottles can be securely filled in this way. Angle steplessly adjustable up to 90°.

- ▶ With universal quick tightening strap
- ▶ Polypropylene/PA



**⑥ Stainless steel beaker**  
Beaker with scraper, contents 1000 ml. Ideal for powder, granules, pastes, mud.

- ▶ Sterilisable
- ▶ Stainless steel V2A (1.4301)



**⑦ Surface catch net**  
Catch net for taking solid and organic samples from water courses.

- ▶ PVC/PA blue
- ▶ L 310 x W 280 mm
- ▶ Mesh width 2 - 5 mm



**⑧ Depth catch net**  
Catch net for taking solid and organic samples from water courses.

- ▶ PP/PA blue
- ▶ L 190 x W 430 mm
- ▶ Net depth 250 mm
- ▶ Mesh width 2 - 5 mm



| ① Telescopic rod                |             |         |                     |               |              |
|---------------------------------|-------------|---------|---------------------|---------------|--------------|
| Length infinitely variable from | No. of rods | Price € | Quantity scale from | Scale price € | Item no.     |
| 65-120 cm                       | 2           | 24.05   | 10                  | 21.90         | 5355-0120 N4 |
| 70-180 cm                       | 4           | 40.75   | 10                  | 37.65         | 5355-0180 N4 |
| 125-250 cm                      | 2           | 30.80   | 10                  | 28.70         | 5355-0250 N4 |
| 95-280 cm                       | 4           | 48.10   | 10                  | 43.50         | 5355-0280 N4 |
| 115-300 cm                      | 3           | 48.10   | 10                  | 43.50         | 5355-0300 N4 |
| 165-450 cm                      | 3           | 67.15   | 10                  | 60.15         | 5355-0450 N4 |
| 175-600 cm                      | 4           | 82.40   | 10                  | 76.40         | 5355-0600 N4 |

| Model                    | Capacity ml | Price € | Quantity scale from | Scale price € | Item no.     |
|--------------------------|-------------|---------|---------------------|---------------|--------------|
| ② Scoop angular beaker   | 600         | 46.00   | 10                  | 41.70         | 5354-0050 N4 |
| ② Scoop angular beaker   | 1000        | 46.95   | 10                  | 42.15         | 5354-0100 N4 |
| ② Scoop angular beaker   | 2000        | 51.60   | 10                  | 46.30         | 5354-0200 N4 |
| ③ Pendulum beaker PP     | 600         | 42.95   | 10                  | 38.70         | 5354-5050 N4 |
| ③ Pendulum beaker PP     | 1000        | 45.05   | 10                  | 40.35         | 5354-5100 N4 |
| ③ Pendulum beaker PP     | 2000        | 49.00   | 10                  | 44.30         | 5354-5200 N4 |
| ④ Pendulum beaker V2A    | 1000        | 163.45  | 5                   | 150.80        | 5354-3000 N4 |
| ⑤ Bottle holder          | 750         | 53.70   | 10                  | 48.20         | 5354-4100 N4 |
| ⑥ Stainless steel beaker | 1000        | 118.70  | 5                   | 106.30        | 5354-2000 N4 |
| ⑦ Surface catch net      |             | 51.75   | 5                   | 48.65         | 5354-5020 N4 |
| ⑧ Depth catch net        |             | 56.55   | 5                   | 53.10         | 5354-5010 N4 |

## Sampler Liquid CupSampler



It is possible to carry out point sampling of liquids of varying viscosity with the stainless steel Liquid CupSampler (V4A). Media-containing particles can also be sampled without difficulty. The sampler can be used in the fields of chemistry, foodstuffs and cosmetics. The cup can be unscrewed from the stem, allowing easy cleaning.

### Use

1. Place the collector at the desired depth.
2. Open the lid using the handle.  
The liquid flows in.
3. Close the filled collector and remove it.
4. Empty the sample into the sample bottle.



### Sampler Liquid CupSampler

| Capacity ml | Container dia. mm | Total length cm | Price € | Item no.     |
|-------------|-------------------|-----------------|---------|--------------|
| 100         | 55                | 100             | 688.55  | 5357-0001 N4 |



## ChemoSampler | for acids, alkalis, detergents



The ChemoSampler was developed for sampling aggressive liquids, e.g. acids, alkalis, detergents. The samples are drawn directly into the screw-on original sampling bottle. The tamper-proof bottle closure of these bottles with original safety ring ensures unadulterated sample transport. Samples can be taken from depths of as much as 200 cm, e.g. from tanks, silos or tankers, by using the extension rod.

- ▶ PP, grey
- ▶ Resistant to acids and alkalis
- ▶ Incl. sample bottle 1000 ml
- ▶ Extension rod 100 cm and two bottle sizes available as accessories.

**!** Attention! Make sure to pay attention to the "List of Chemical Resistance"!

### ChemoSampler

| Price € | Quantity scale from | Scale price € | Item no.     |
|---------|---------------------|---------------|--------------|
| 68.10   | 5                   | 59.65         | 5336-1000 N4 |

### Accessories

| Description                       | Price € | Item no.     |
|-----------------------------------|---------|--------------|
| Extension for ChemoSampler 100 cm | 33.75   | 5336-0100 N4 |
| Sampling bottle PE, 500 ml        | 2.42    | 0342-0500 N3 |
| Sampling bottle PE, 1000 ml       | 2.49    | 0342-1000 N3 |

## Bürkle worldwide

Even if we are not just round the corner,  
one of our partners is sure to be not far from you!



Are you looking for a local contact or sales partner?

Under [www.buerkle.de](http://www.buerkle.de) → Company → Distributors & Partners you can find out  
who your local direct contact to Bürkle is – even worldwide.

## MiniSampler | taking samples – comfortable, quick and clean sampling



With the vacuum sampler MiniSampler, the sample liquid only comes into contact with the suction hose and the original sample bottle. The possibility of cross-contamination is greatly reduced. Immediately after taking the sample, the bottles are sealed. The disposable suction hose can quickly be replaced. This guarantees that the samples are never contaminated. If necessary, a new hose can be used for every single sample.

Due to its small diameter (8 mm), the hose can reach narrow, seemingly inaccessible sampling areas.

### Two models:

PE MiniSampler for general sampling, max. suction height 5 m\*

PTFE MiniSampler for ultra-pure sampling, max. suction height 5 m\*

\* depending on the medium

- ▶ Also suitable for viscous oils
- ▶ Complete in a handy transport case

### Use

1. Insert the hose and the bottle into the pump.
2. Insert hose end to desired sample depth.
3. Move the pump piston back and forth and collect the sample.  
The liquid flows directly into the bottle.
4. Take off the filled bottle, close and label it.

Not for aggressive acids. Vapors could destroy pump.

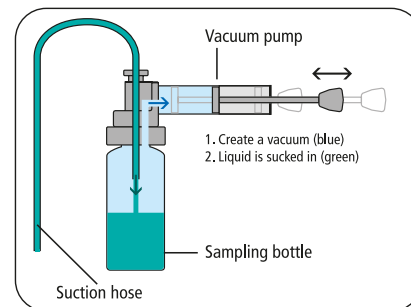

## MiniSampler PE | for general sampling



Ideal for general sampling from barrels, canisters, tanks etc. MiniSampler PE complete with accessories in transport case, contents: Vacuum pump, 10 PE bottles, 100 ml, 10 m PE suction hose 6 x 8 mm, 1 hose cutter, 1 stainless steel hose weight made of V2A (1.4301), 20 seal-it bottle seals.

## MiniSampler PTFE | for ultrapure sampling



Ideal when maximum purity is needed. MiniSampler PTFE complete with accessories in its transport case, contents: Vacuum pump, 1 sample bottle PFA 180 ml, 5 m PTFE suction hose 6 x 8 mm, 1 hose cutter, 1 stainless steel hose weight made of V2A (1.4301), 20 seal-it bottle seals.

### MiniSampler PE



| Price € | Quantity scale from | Scale price € | Item no.     |
|---------|---------------------|---------------|--------------|
| 165.50  | 5                   | 146.95        | 5305-0100 N4 |

#### Accessories

| Description  | Price € | Item no.     |
|--|---------|--------------|
| MiniSampler pump with adapter PP                                   | 71.70   | 5305-0010 N4 |
| MiniSampler standard pump  | 45.65   | 5305-0011 N4 |
| PTFE MiniSampler adapter for glass thread GL 45                    | 127.20  | 5305-0209 N4 |
| MiniSampler adapter PTFE for sample tubes PFA 6205-0090, 6205-0180 | 77.75   | 5305-1020 N2 |
| Hose cutter  | 7.50    | 0006-9506 N3 |
| Sampling bottle HDPE, 100 ml                                       | 1.61    | 0340-0100 N3 |
| Sampling bottle HDPE, 250 ml                                       | 1.96    | 0340-0250 N3 |
| Sampling bottle HDPE, 500 ml                                       | 2.31    | 0340-0500 N3 |
| Sampling bottle HDPE, 1000 ml                                      | 2.99    | 0340-1000 N3 |
| Suction hose PE on roll 6 x 8 mm, roll with 10 m                   | 14.30   | 8805-0608 N3 |
| Suction hose PE on roll 6 x 8 mm, roll with 100 m                  | 46.00   | 8878-0608 N3 |

### MiniSampler PTFE



| Price € | Quantity scale from | Scale price € | Item no.     |
|---------|---------------------|---------------|--------------|
| 271.80  | 5                   | 246.90        | 5305-0110 N4 |

#### Accessories

| Description  | Price € | Item no.     |
|--|---------|--------------|
| MiniSampler pump with adapter PP                                   | 71.70   | 5305-0010 N4 |
| MiniSampler standard pump  | 45.65   | 5305-0011 N4 |
| PTFE MiniSampler adapter for glass thread GL 45                    | 127.20  | 5305-0209 N4 |
| MiniSampler adapter PTFE for sample tubes PFA 6205-0090, 6205-0180 | 77.75   | 5305-1020 N2 |
| Hose cutter  | 7.50    | 0006-9506 N3 |
| Sample boxes PFA, 90 ml  | 56.45   | 6205-0090 N3 |
| Sample boxes PFA, 180 ml   | 73.05   | 6205-0180 N3 |
| Suction hose PTFE on roll 6 x 8 mm, roll with 5 m                  | 40.35   | 8804-0608 N3 |

## ProfiSampler | vacuum-operated sample collector for robust industrial use

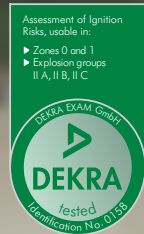

①

ProfiSampler Aluminium



①

While the MiniSampler is designed for laboratory use, the ProfiSampler has been specially developed for rough industrial use.

### Applications

Sampling liquids in barrels, tanks, lorries, railway goods wagons, ships, water courses, ground water, etc.

Vacuum samplers have the advantage that the sample liquid only comes into contact with the suction hose and the original sample bottle. The possibility of cross-contamination is greatly reduced. Immediately after taking the sample, the bottles are sealed. The disposable suction hose can quickly be replaced. This guarantees that the samples are always authentic. If necessary, a new hose can be used for every single sample.

Due to its small diameter (8 mm), the hose can reach narrow, seemingly inaccessible sampling areas.

The ProfiSampler can be extended with useful accessories developed in practice.

**⚠ Attention!** Make sure to pay attention to the "List of Chemical Resistance"!

- ▶ Three feet guarantee that the ProfiSampler stands safely
- ▶ Fill level control, automatic return flow and overflow protection through built-in venting valve
- ▶ Available with suction hose in PE, PA and PTFE wherever the highest degree of purity is required
- ▶ Can be supplied with straight suction tubes for simpler sampling, incl. transport case for tidy transport and disposal of the suction tubes
- ▶ Suction volume 200 ml, suction pressure 0.5 bar
- ▶ Suction height from liquid surface 5 m WS
- ▶ Sample bottles available in different materials and sizes



## ProfiSampler | vacuum-operated sample collector for robust industrial use

① **ProfiSampler Aluminium** for solvents and flammable liquids in Explosion Categories IIA, IIB and IIC. With bottle thread GL 45 (suitable for Schott glass bottles 100 ml to 1000 ml).

When taking samples of flammable liquids, the device must be earthed. For this, earthing cable and, possibly in addition, anti-static set should be used, see accessories.

ProfiSampler aluminium, consisting of: Vacuum pump made of aluminium, with feet, venting valve and bottle thread GL 45 with glass bottle 500 ml, 5 suction tubes PA black, 220 cm long, electrically conductive, hose cutter, brass hose weight, 20 seal-it bottle seals, earthing cable.

② **Profi Sampler PP** for general samples, for weak acids, alkalis, detergents, chemical baths. Made of solid, chemical resistant Polypropylene.

ProfiSampler PP, consisting of: Vacuum pump, made of solid PP, with feet, venting valve and bottle thread GL 40, 1 PP bottle 250 ml, 10 m PE suction hose (roll), 1 hose cutter, 1 stainless steel hose weight made of V2A (1.4301), 20 seal-it bottle seals.



③ **Straight suction tubes** (PE or PA) have the advantage that they are not slightly bent as is the standard tubing (from the roll) and can therefore be immersed absolutely vertically into the container. The suction tubes are available in transparent PE for general sampling and black PA for flammable liquids in VbF Hazard Category AI (electrically conducting). Diameter 6 x 8 mm. Contamination banned! In practice the low-priced tubes are only used once. They are then disposed of, instead of being subjected to a costly cleaning process. The tubes are not autoclavable.

④ **Transport case for straight suction tubes** for the practical transport of new suction tubes and the safe storage of used ones. Suitable for 100 suction tubes, 220 cm long.

| ① ProfiSampler Aluminium |                     |               |              |  |  |
|--------------------------|---------------------|---------------|--------------|--|--|
| Price €                  | Quantity scale from | Scale price € | Item no.     |  |  |
| 434.35                   | 5                   | 395.00        | 5305-1100 N4 |  |  |

| Accessories   |         |              |
|---|---------|--------------|
| Description   | Price € | Item no.     |
| Glass sampling bottle 100 ml, GL 45   | 6.65    | 5314-0010 N3 |
| Glass sampling bottle 250 ml, GL 45   | 11.30   | 5314-0025 N3 |
| Glass sampling bottle 500 ml, GL 45   | 10.70   | 5314-0050 N3 |
| Glass sampling bottle 1000 ml, GL 45  | 12.55   | 5314-0100 N3 |
| ③ Straight suction tube, PE transparent, 200 cm, 10 pieces                  | 106.25  | 5305-1022 N4 |
| ③ Straight suction tube, PA black, electrical conductive, 220 cm, 10 pieces | 134.65  | 5305-1024 N4 |
| ④ Transport case for straight suction tubes                                 | 122.25  | 5305-1029 N4 |
| Anti-static set   | 46.45   | 5602-1000 N4 |
| Suction hose PE on roll 6 x 8 mm, roll with 10 m                            | 14.30   | 8805-0608 N3 |
| Suction hose PE on roll 6 x 8 mm, roll with 100 m                           | 46.00   | 8878-0608 N3 |
| Suction hose PTFE on roll 6 x 8 mm, roll with 5 m                           | 40.35   | 8804-0608 N3 |

| ② Profi Sampler PP |  |  |              |  |  |
|--------------------|--|--|--------------|--|--|
| Price €            |  |  | Item no.     |  |  |
| 335.75             |  |  | 5305-1000 N4 |  |  |

| Accessories   |         |              |
|---|---------|--------------|
| Description   | Price € | Item no.     |
| ③ Straight suction tube, PE transparent, 200 cm, 10 pieces                  | 106.25  | 5305-1022 N4 |
| ③ Straight suction tube, PA black, electrical conductive, 220 cm, 10 pieces | 134.65  | 5305-1024 N4 |
| ④ Transport case for straight suction tubes                                 | 122.25  | 5305-1029 N4 |
| Sampling bottle PP, 250 ml  | 1.87    | 0319-0250 N3 |
| Suction hose PE on roll 6 x 8 mm, roll with 10 m                            | 14.30   | 8805-0608 N3 |
| Suction hose PE on roll 6 x 8 mm, roll with 100 m                           | 46.00   | 8878-0608 N3 |

## Liqui zone samplers



Up to three point samples from different depths of a liquid can be taken with the Bürkle zone sampler for liquids.

If particles separate in liquids or emulsions, if the components de-mix or they form different layers, then sampling from various depths and areas is necessary to obtain a representative sample.

With the handy carrying case, the samples can be emptied directly into the sample bottles.

The Liqui zone sampler can be easily cleaned, it has good chemical resistance and is suitable for food, because the medium only comes into contact with the hose. The suction hoses made of PE or PTFE can be adjusted to the required length and can be replaced any time as cost-effective accessories.

The sampling device is ideal for use with barrels, tanks, wells, waste water plants and water purification plants.

**!** Attention! Make sure to pay attention to the "List of Chemical Resistance"!

The manual zone sampler for liquids is operated with a vacuum pump.

The vacuum pump can reach suction of 0.5 bar and therefore has a suction height of about 4 metres.

- ▶ Suction height up to 4 m
- ▶ Suction pressure 0.5 bar



### Liqui zone sampler



Price €  
608.00

Item no.  
5329-1000

N4

## UniSampler with hose



UniSampler with PVC hose and hose weight made of stainless steel. For deep, hard-to-reach places. The mass of the metal tube drags the hose to any depth.

- ▶ Suction hose PVC, 2.50 m long
- ▶ Complete in a handy transport case incl. sample bottle PP 1000 ml, vacuum pump, universal bottle adapter, hose weight made of V2A, 20 seal-it bottle seals
- ▶ Universal bottle adapter made of PVC, for bottle necks Ø 24 mm, 32 mm, 39 mm and 50 mm nominal dimension, for sample bottles 100 - 1000 ml

### Use

1. Lower the suction hose to the required depth.
2. Attach the adapter to the sampling bottle.
3. Create a vacuum using the handpump and collect the sample.
4. Remove the filled sample bottle, close and label it.

| UniSampler with hose                    |                     |               |              |
|---|---------------------|---------------|--------------|
| Price €                                 | Quantity scale from | Scale price € | Item no.     |
| 167.10                                  | 5                   | 149.25        | 5314-2000 N4 |
| Accessories                             |                     |               |              |
| Description                             | Price €             | Item no.      |              |
| Suction hose for replacement PVC, 2,5 m | 1.84                | 5314-2002     | N4           |
| Sampling bottle PP, 100 ml              | 1.36                | 0319-0100     | N3           |
| Sampling bottle PP, 250 ml              | 1.87                | 0319-0250     | N3           |
| Sampling bottle PP, 500 ml              | 3.07                | 0319-0500     | N3           |
| Sampling bottle PP, 1000 ml             | 5.10                | 0319-1000     | N3           |

## UniSampler "Ex"



Sampler especially developed for sampling flammable liquids of Hazard Category AI (VbF, e.g. fuel). Glass bottle and hose are connected in such a way that they conduct electricity and are earthed via an earthing cable.

- ▶ Complete in a handy transport case incl. 4m hose (NBR), glass bottle 1000 ml, bottle adapter, vacuum pump, earthing cable and hose-weight made of brass
- ▶ PTB approval D-333-009 618/00

### Use

1. Earth the device.
2. Lower the suction hose to the required depth.
3. Attach the adapter to the sampling bottle.
4. Create a vacuum using the handpump and collect the sample.
5. Remove the filled sample bottle, close and label it.

The UniSampler "Ex" was developed in co-operation with the quality association Tankschutz e.V. (non-profit association for tank protection).

| UniSampler "Ex"                      |                     |               |              |
|--------------------------------------|---------------------|---------------|--------------|
| Price €                              | Quantity scale from | Scale price € | Item no.     |
| 307.75                               | 5                   | 291.30        | 5314-3000 N4 |
| Accessories                          |                     |               |              |
| Description                          | Price €             | Item no.      |              |
| Glass sampling bottle 1000 ml, GL 45 | 12.55               | 5314-0100     | N3           |

## UniSampler with suction lance



### Use

1. Set the desired sampling depth by moving the suction lance.
2. Attach the adapter to the sampling bottle.
3. Lower the suction lance into the medium.
4. Create a vacuum using the hand-pump and collect the sample.
5. Remove the filled sample bottle, close and label it.

The collection lance consists of an inner tube and an outer tube. The suction position can be varied steplessly with the outer tube within a height of 0 to 48 cm. The total length of the telescopic suction tube is 100 cm.

- ▶ Suction tube PP, suction hose PVC
- ▶ Incl. 5 sample bottles each PP 250 ml and 500 ml, vacuum pump, universal adapter for sample bottles, 20 seal-it bottle seals
- ▶ Universal bottle adapter made of PVC, for bottle necks Ø 24 mm, 32 mm, 39 mm and 50 mm nominal dimension, for sample bottles 100 - 1000 ml

### UniSampler with suction lance

| Price € | Quantity scale from | Scale price € | Item no.     |
|---------|---------------------|---------------|--------------|
| 201.35  | 5                   | 179.05        | 5314-1000 N4 |

### Accessories

| Description                 | Price € | Item no.     |
|-----------------------------|---------|--------------|
| Sampling bottle PP, 100 ml  | 1.36    | 0319-0100 N3 |
| Sampling bottle PP, 250 ml  | 1.87    | 0319-0250 N3 |
| Sampling bottle PP, 500 ml  | 3.07    | 0319-0500 N3 |
| Sampling bottle PP, 1000 ml | 5.10    | 0319-1000 N3 |

## Bürkle - Behind the scenes

There are many ways for ordering at Bürkle - but all roads lead to the Sales department.



[www.buerkle.de](http://www.buerkle.de)

You can reach us around the clock!



Are you not sure whether a product is the right for you? Just ask us:

+49 (0) 7635 / 8 27 95 - 0



As soon as you have ordered a product, Production, and Materials Management take over personally.

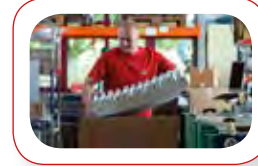

By the way: If your product is in stock and you order before 1.00 p.m., the package leaves our store the same day.



Are you in a hurry? We also offer express deliveries.

## Vampire Sampler | for sampling liquids in the field



Transportable, hose pump for liquids, independent of mains power. Ideal for sampling from barrels, tanks, wells, water separators and sewage and purification systems.

Vampire is packed in a handy transport case with: drive unit, two rechargeable batteries, battery charger, LED lamp, bottle holder, bottle LDPE 250 ml, hose pump and 5 m hose made of PE.

- ▶ Easy cleaning, liquid is only in contact with the hose
- ▶ Independent of mains power with rechargeable batteries and charger, incl. replacement battery
- ▶ Sampling directly into the original sample bottle
- ▶ Suction height up to 5 m
- ▶ Also suitable for contaminated substances or media containing particles
- ▶ Good chemical resistance
- ▶ Good delivery rate up to 2.0 l/min



### Vampire Sampler

| Price € | Quantity scale from | Scale price € | Item no.     |
|---------|---------------------|---------------|--------------|
| 763.70  | 5                   | 728.05        | 5327-1000 N2 |

### Accessories

| Description                                       | Price € | Item no.     |
|---|---------|--------------|
| Suction hose Marprene, 1m                         | 41.50   | 5327-0508 N2 |
| Sampling bottle LDPE 500 ml                       | 2.72    | 0318-0500 N3 |
| Suction hose PE on roll 6 x 8 mm, roll with 10 m  | 14.30   | 8805-0608 N3 |
| Suction hose PE on roll 6 x 8 mm, roll with 100 m | 46.00   | 8878-0608 N3 |
| Basket for sample bottles 250 ml                  | 38.50   | 5302-2025 N2 |
| Basket for sample bottles 500 ml                  | 48.05   | 5302-2051 N2 |
| Basket for sample bottles 1000 ml                 | 64.15   | 5302-2101 N2 |

## Dipping bottles



Dipping containers are used in various areas to collect liquids for sampling. Bürkle produces the most comprehensive collection of dipping containers by a long way, the right product for every use as it were. Bürkle offers dipping bottles and immersion cylinders for sediments, for the area of environmental issues, for chemically aggressive products, for petrochemistry, for the ex protection area etc. The dipping bottles for the Ex protection area are made of nickel-plated brass, therefore they do not oxidise.

Dipping vessels can be used for point sampling, all-layer samples and soil samples. Dipping vessels are heavy. Lowering requires the use of special manually-operated drum reels with a large winding diameter. Other manually-operated drum reels place too much strain on the user's wrist and could represent a health hazard. Lowering cables and chains made from different materials, as well as manually-operated drum reels, also for Ex-proof applications, available as accessories.

**!** Observe Ex-proof guidelines when sampling flammable liquids. Only use conductive lowering cables made of nonspark-producing material and conductive hand reels with grounding connection.

## Dipping bottle

Dipping bottle with glass container for sampling in sewage plants, for mud and water samples. For testing crude oil, liquid mineral oil products, fuels, special and test fuels, fuel oils, petroleum and liquid lubricants of Hazard Categories IIA and IIB. Completely made from non-spark producing materials. Dipping frame made of nickel-plated brass, easy-click closure made of electrically conductive polyamide.

- ▶ With Easy-Click, safe and practical closure for a rapid bottle exchange
- ▶ High weight (3.3 kg) for fast lowering
- ▶ Bottle made of transparent glass 1000 ml contents
- ▶ Height with handles 330 mm
- ▶ Please order the appropriate lowering cable at the same time (page 120)
- ▶ Tested for use in the Ex protection zone 0

### Use

1. Lower the dipping bottle to the required depth.
2. Pull chain/cable with a short, powerful jerk, the stopper opens.
3. The sample flows into the bottle.
4. Raise the bottle with the chain/cable.
5. Open the Easy-Click, remove the bottle.

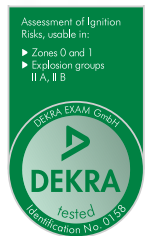

### Dipping bottle

| Capacity ml | Dia. mm | Price € | Item no.     |
|-------------|---------|---------|--------------|
| 1000        | 148     | 411.05  | 5365-4000 N4 |



## Dipping bottle Ex

Dipping bottle for testing mineral oil products Category A, Explosion Categories IIA, IIB and IIC, crude oil, liquid mineral oil products, fuels, special and test fuels, fuel oils, petroleum and liquid lubricants. Completely made from non-spark producing materials, nickel-plated

- ▶ Screw-off bottle head - easy cleaning
- ▶ Robust handle
- ▶ High weight (3.2 kg) for fast lowering
- ▶ 1000 ml contents
- ▶ Height with handles 443 mm
- ▶ Please order the appropriate lowering cable at the same time (page 120)
- ▶ Tested for use in the Ex protection zone 0



### Use

1. Lower the dipping bottle to the required depth.
2. Pull chain/cable with a short, powerful jerk, the stopper opens.
3. The sample flows into the bottle.
4. Raise the bottle with the chain/cable.
5. Empty the bottle.

### Dipping bottle Ex

| Capacity ml | Dia. mm | Price € | Item no.     |
|-------------|---------|---------|--------------|
| 1000        | 89      | 419.85  | 5365-3000 N4 |



## Immersion cylinder

Immersion cylinder for sampling crude oil, liquid mineral oil products, fuels, special and test fuels, fuel oils, petroleum and liquid lubricants in Explosion Categories IIA, IIB and IIC. Completely made from non-spark producing materials, nickel-plated.

- ▶ Screw-off top enables easy cleaning
- ▶ High weight (4.1 kg) for fast lowering
- ▶ Robust handle
- ▶ 1000 ml contents
- ▶ Height with handles 438 mm
- ▶ Please order the appropriate lowering cable at the same time (page 120)
- ▶ Tested for use in the Ex protection zone 0

### Use

#### Point sampling

1. Two lowering cables are required for this (bearer cable and hauling cable).
2. Lower the immersion cylinder to the required depth.
3. When the target has been reached, pull on the hauling cable, the valve opens.
4. The sample flows into the bottle.
5. Release the hauling cable. The valve closes. Pull the cylinder back on the bearer cable.
6. Empty the cylinder via the valve at the bottom.

#### Soil sample

1. Lower the immersion cylinder on the cable to the ground.
2. The valve opens automatically because of the immersion cylinder's own weight.
3. The sample flows into the cylinder.
4. Pull the cylinder back on the cable, the valve closes independently.
5. Empty the cylinder via the valve at the bottom.



### Immersion cylinder

| Capacity ml | Dia. mm | Price € | Item no.     |
|-------------|---------|---------|--------------|
| 1000        | 75      | 524.90  | 5365-7000 N4 |

## Dipping vessel

Dipping vessel for taking all-layer samples from tanks, tank wagons, water courses, water purification plants.

- ▶ With Easy-Flow, the flow optimised flow valve
- ▶ High weight (2.1 kg) for faster lowering
- ▶ Contents 1000 ml
- ▶ Height with handles 427 mm
- ▶ Made of non-spark producing brass or stainless steel V2A (1.4301) for Ex area
- ▶ Please order the appropriate lowering cable at the same time (page 120)
- ▶ Tested for use in the Ex protection zone 0
- ▶ Explosion Categories IIA, IIB and IIC



### Use

1. When the dipping vessel is lowered, the liquid constantly runs through it.
2. When it is pulled back, both valves close automatically.
3. Emptying at the top via the open flaps.

### Dipping vessel

| Material                 | Dia. mm | Price € | Item no.  |    |  |  |  |  |
|--------------------------|---------|---------|-----------|----|--|--|--|--|
| brass                    | 82      | 456.85  | 5365-1000 | N4 |  |  |  |  |
| stainless steel AISI 304 | 82      | 898.60  | 5365-2000 | N4 |  |  |  |  |

## Mini immersion cylinder

For sampling liquids in narrow places where access is difficult. Can also be used in curved dipping tubes and barrels with narrow openings.

Diameter only 32 mm.

- ▶ 50 ml contents
- ▶ Height 180 mm
- ▶ Weight 350 g
- ▶ Stainless steel V2A (1.4301)
- ▶ Screw-off top enables easy cleaning
- ▶ Please order the appropriate lowering cable at the same time (page 120)
- ▶ Tested for use in the Ex protection zone 0
- ▶ Explosion Categories IIA and IIB



### Use

1. When the dipping vessel is lowered, the liquid constantly runs through it.
2. When it is pulled back, both valves close automatically.
3. It can be emptied via the base valve or the upper screw-off cap.

### Mini immersion cylinder

| Capacity ml | Dia. mm | Height mm | Price € | Item no.  |    |  |  |  |  |
|-------------|---------|-----------|---------|-----------|----|--|--|--|--|
| 50          | 32      | 180       | 251.90  | 5365-5000 | N4 |  |  |  |  |



## Target immersion cylinder



Precise liquid samples can be taken with the Target immersion cylinder.

- ▶ Weight 2.5 kg
- ▶ Incl. venting lowering cable (5 m), valve and cable reel
- ▶ Screw-off top enables easy cleaning

### Use

1. Lower the immersion cylinder to the required depth on the high-tensile, closed hose.
2. When the target has been reached, open the air valve at the tube end.
3. This vents the immersion cylinder and fills it.
4. Retrieve the immersion cylinder.
5. Open the cover and pour out the sample.

| Target immersion cylinder |         |           |         |              |
|---------------------------|---------|-----------|---------|--------------|
| Capacity ml               | Dia. mm | Height mm | Price € | Item no.     |
| 500                       | 75      | 210       | 364.50  | 5365-6000 N4 |

## AquaSampler



Sampler for ground water samples from wells, pits and other sources. Fits all normal well shafts with control openings to Ø 2", without tilting or getting stuck. Ultra pure materials guarantee the highest degree of sample purity. Easy to clean thanks to rounded edges and threads.

- ▶ FEP/PTFE ultra pure, anti adhesive surface
- ▶ Without cable

### Available as accessory (page 120):

- ▶ Robust manually-operated drum reel PP
- ▶ Lowering cable, V2A-woven, PTFE coated

| AquaSampler |                 |               |         |                     |               |              |
|-------------|-----------------|---------------|---------|---------------------|---------------|--------------|
| Capacity ml | Total length cm | Outer dia. mm | Price € | Quantity scale from | Scale price € | Item no.     |
| 350         | 40              | 46            | 264.30  | 5                   | 228.95        | 5308-0350 N4 |
| 700         | 76              | 46            | 298.80  | 5                   | 278.15        | 5308-0700 N4 |
| 1050        | 107             | 46            | 345.35  | 5                   | 305.85        | 5308-1050 N4 |

## Manually-operated reels



Manually-operated drum reel PP



Manually-operated drum reel PA electrically-conductive



Manually-operated reel Ex with grounding cable

The manually-operated drum reels are used to lower dipping bottles and immersion cylinders safely to the required depth in shafts, wells and tanks and then to pull them up again. The manually-operated drum reels can be equipped with various cables or chains. If flammable or highly flammable liquids are to be collected, then electrically conductive manually-operated drum reels must be used together with an earthing cable. The dipping bottles must be made of non-sparking metal.

- ▶ High winding capacity of up to 150 m for cable 2 mm dia.
- ▶ Reel width: inner 44 mm, outer 55 mm, reel diameter: inner 100 mm, outer 180 mm

**!** Please order the required lowering cable separately.



| Manually-operated reel                           |         |           |    |
|--|---------|-----------|----|
| Model  | Price € | Item no.  |    |
| ① Manually-operated reel PP                      | 71.70   | 5309-0010 | N4 |
| ② Manually-operated reel PA                      | 122.25  | 5309-0020 | N4 |
| ③ Manually-operated reel Ex with grounding cable | 191.50  | 5309-0030 | N4 |

## Lowering cables

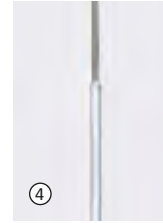

Stainless steel lowering cable, PTFE-coated

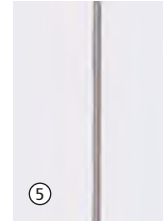

Lowering cable V2A



Lowering cable plastic

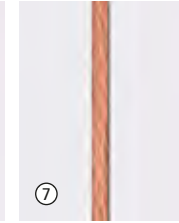

Copper cable with loops

### Lowering cables

For dipping bottles and immersion cylinders, matching manually-operated drum reels made of various materials. Tensile load max. up to 10 kg.



Lowering/hoisting chain stainless steel



Snap-hook V4A



Brass shackle

| Lowering cable                                |          |         |         |              |
|---|----------|---------|---------|--------------|
| Model   | Length m | Dia. mm | Price € | Item no.     |
| ④ Stainless steel lowering cable, PTFE-coated | 10       | 2       | 32.80   | 5309-0110 N4 |
| ④ Stainless steel lowering cable, PTFE-coated | 25       | 2       | 77.75   | 5309-0125 N4 |
| ④ Stainless steel lowering cable, PTFE-coated | 50       | 2       | 150.65  | 5309-0150 N4 |
| ⑤ Stainless steel lowering cable              | 10       | 1,25    | 25.90   | 5309-0301 N4 |
| ⑤ Stainless steel lowering cable              | 25       | 1,25    | 54.35   | 5309-0302 N4 |
| ⑤ Stainless steel lowering cable              | 50       | 1,25    | 100.10  | 5309-0305 N4 |
| ⑥ Lowering cable made of PP cord              | 10       | 2       | 10.15   | 5309-0201 N4 |
| ⑥ Lowering cable made of PP cord              | 25       | 2       | 23.10   | 5309-0202 N4 |
| ⑥ Lowering cable made of PP cord              | 50       | 2       | 44.45   | 5309-0205 N4 |
| ⑦ Copper lowering cable EX with loops         | 10       | 4,5     | 89.10   | 5309-0410 N4 |
| ⑦ Copper lowering cable EX with loops         | 25       | 4,5     | 197.55  | 5309-0425 N4 |
| ⑦ Copper lowering cable EX with loops         | 50       | 4,5     | 382.65  | 5309-0450 N4 |
| ⑧ Stainless steel chains                      | 10       | 2,3     | 95.25   | 5309-0510 N4 |
| ⑧ Stainless steel chains                      | 25       | 2,3     | 226.00  | 5309-0525 N4 |
| ⑧ Stainless steel chains                      | 50       | 2,3     | 396.40  | 5309-0550 N4 |
| ⑨ Snap hooks V4A                              |          | 5       | 7.20    | 0006-5300 N4 |
| ⑩ Shackles                                    |          | 4,5     | 10.25   | 0006-5301 N4 |

# DispoSampler – disposable samplers | for the highest standards in sampling



Bürkle disposable samplers – DispoSampler – are used to take samples of liquids, viscous media, powders and granulates. Target point samples can be taken, all-layer and cross-section samples, as well as small and large sample quantities.

Unlike conventional reusable samplers, disposable samplers do not need to be cleaned after use.



- ▶ Cleaning reusable samplers is a demanding and often complicated task, with greasy, strongly adhesive or toxic substances. Sometimes the task is even impossible
- ▶ Work processes do not have to be interrupted by cleaning
- ▶ Cross contamination is completely eliminated
- ▶ The cleaning method does not need to be validated in audits
- ▶ Time and money are saved



## Bürkle DispoSampler LaboPlast® and SteriPlast®

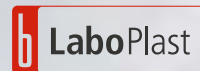

- ▶ Individually packaged
- ▶ Production, assembly and packaging in class 7 clean room (10,000)
- ▶ With EU foodstuffs and FDA approval
- ▶ Optionally sterilised by gamma rays



*Time is money – Compare the costs:*

- Bring to cleaning area
- Remove sampler
- Cleaning agent
- Work time
- Autoclaving in some cases
- Drying
- Mount sampler
- Packaging if required
- Transport and storage

*Due to the effort involved in cleaning and the costs associated with it, it is often more economical to use a Bürkle disposable sampler.*



## LiquiDispo



The LiquiDispo disposable sampler can be used to take samples of liquids from highly liquid to slightly viscous. An ergonomic handle makes it easier to draw the sample: up to 200 ml can be drawn, as with a syringe.

- ▶ Ergonomic handle
- ▶ No seals
- ▶ HDPE
- ▶ Clean room manufactured
- ▶ Optionally sterilised by gamma rays
- ▶ Ø 21 mm



| Length mm | Volume ml | Model      | Pieces per pack | Price € | Quantity scale from | Scale price € | Item no.  |    |
|-----------|-----------|------------|-----------------|---------|---------------------|---------------|-----------|----|
| 500       | 100       | standard   | 20              | 105.60  | 10                  | 100.30        | 5393-1120 | N4 |
| 500       | 100       | sterilized | 20              | 122.40  | 10                  | 116.30        | 5393-1121 | N4 |
| 1000      | 200       | standard   | 20              | 129.60  | 10                  | 123.10        | 5393-1130 | N4 |
| 1000      | 200       | sterilized | 20              | 160.80  | 10                  | 152.80        | 5393-1131 | N4 |

## DispoPipette



Simple disposable sampler for taking samples of low viscosity media. If the DispoPipette is inserted into the liquid opened, an all-layer sample is obtained. If it is closed while it is inserted up to the sampling point and then opened, a target-point sample is obtained. Very easy to operate. With two opening sizes (2,5/5,5 mm) for different viscosities.

- ▶ All-layer and target point samples possible
- ▶ HDPE
- ▶ Clean room manufactured
- ▶ Optionally sterilised by gamma rays
- ▶ Ø 21 mm



| Length mm | Volume ml | Model      | Pieces per pack | Price € | Quantity scale from | Scale price € | Item no.  |    |
|-----------|-----------|------------|-----------------|---------|---------------------|---------------|-----------|----|
| 500       | 100       | standard   | 20              | 69.60   | 10                  | 66.10         | 5393-5500 | N4 |
| 500       | 100       | sterilized | 20              | 81.60   | 10                  | 77.50         | 5393-5501 | N4 |
| 1000      | 200       | standard   | 20              | 81.60   | 10                  | 77.50         | 5393-5531 | N4 |
| 1000      | 200       | sterilized | 20              | 100.80  | 10                  | 95.80         | 5393-5532 | N4 |

## DispoTube



The ergonomic handle of the DispoTube makes it easier to work and facilitates a good grip even under difficult conditions, for example with gloves. Disposable sampler for taking samples of liquids.

- ▶ Ergonomic handle
- ▶ All-layer and target point samples possible
- ▶ HDPE
- ▶ Clean room manufactured
- ▶ Optionally sterilised by gamma rays
- ▶ Ø 21 mm



| DispoTube |           |            |                 |         |                     |               |           |    |
|-----------|-----------|------------|-----------------|---------|---------------------|---------------|-----------|----|
| Length mm | Volume ml | Model      | Pieces per pack | Price € | Quantity scale from | Scale price € | Item no.  |    |
| 500       | 100       | standard   | 20              | 79.20   | 10                  | 75.20         | 5393-6620 | N4 |
| 500       | 100       | sterilized | 20              | 91.20   | 10                  | 86.60         | 5393-6621 | N4 |
| 1000      | 200       | standard   | 20              | 96.00   | 10                  | 91.20         | 5393-6630 | N4 |
| 1000      | 200       | sterilized | 20              | 112.00  | 10                  | 106.40        | 5393-6631 | N4 |

## ViscoDispo



The ViscoDispo disposable sampler can be used to take samples of high-viscosity media up to 100.000 mPas. The ergonomically shaped handle and the very stable drawbar make it easy to draw even viscous substances.

- ▶ Ergonomic handle
- ▶ No seals
- ▶ HDPE
- ▶ Clean room manufactured
- ▶ Optionally sterilised by gamma rays
- ▶ Ø 21 mm



| ViscoDispo |           |            |                 |         |                     |               |           |    |
|------------|-----------|------------|-----------------|---------|---------------------|---------------|-----------|----|
| Length mm  | Volume ml | Model      | Pieces per pack | Price € | Quantity scale from | Scale price € | Item no.  |    |
| 500        | 100       | standard   | 20              | 105.60  | 10                  | 100.30        | 5393-3320 | N4 |
| 500        | 100       | sterilized | 20              | 122.40  | 10                  | 116.30        | 5393-3321 | N4 |
| 1000       | 200       | standard   | 20              | 129.60  | 10                  | 123.10        | 5393-3330 | N4 |
| 1000       | 200       | sterilized | 20              | 160.80  | 10                  | 152.80        | 5393-3331 | N4 |

## PowderDispo



PowderDispo is the ideal disposable sampler for cross-section samples of powdery or slightly cohesive substances. A complete all-layer sample can be taken from bags or smaller containers with the lance.

- ▶ HDPE
- ▶ Clean room manufactured
- ▶ Optionally sterilised by gamma rays
- ▶ Ø 21 mm



| Length mm | Volume ml | Model        | Pieces per pack | Price € | Quantity scale from | Scale price € |  | Item no.     |
|-----------|-----------|--------------|-----------------|---------|---------------------|---------------|--|--------------|
| 300       | 60        | standard     | 20              | 88.80   | 10                  | 84.40         |  | 5393-5510 N4 |
| 300       | 60        | sterilized   | 20              | 100.80  | 10                  | 95.80         |  | 5393-5511 N4 |
| 500       | 100       | standard     | 20              | 112.80  | 10                  | 107.20        |  | 5393-5522 N4 |
| 500       | 100       | sterilisiert | 20              | 103.20  | 10                  | 98.00         |  | 5393-5521 N4 |

## DispoPicker



Disposable sampler for powders and small-grain bulk materials. Because the tip is closed, the sample material cannot trickle back out of the sample lance. DispoPicker is ideally suited for cross-section samples.

- ▶ HDPE
- ▶ Clean room manufactured
- ▶ Optionally sterilised by gamma rays
- ▶ Ø 21 mm



| Length mm | Volume ml | Model      | Pieces per pack | Price € | Quantity scale from | Scale price € |  | Item no.     |
|-----------|-----------|------------|-----------------|---------|---------------------|---------------|--|--------------|
| 300       | 60        | standard   | 20              | 79.20   | 10                  | 75.20         |  | 5393-5540 N4 |
| 300       | 60        | sterilized | 20              | 91.20   | 10                  | 86.60         |  | 5393-5541 N4 |
| 500       | 100       | standard   | 20              | 91.20   | 10                  | 86.60         |  | 5393-5550 N4 |
| 500       | 100       | sterilized | 20              | 103.20  | 10                  | 98.00         |  | 5393-5551 N4 |

## DispoLance



The DispoLance disposable sampler can be used for taking large and small sample quantities quickly and easily, directly from bags. The sampler is suitable for free-flowing powders and small-grain granulates. The DispoLance sampler pierces into the container with the sturdy tip and the sample flows through the open inner tube directly into the container or bag that is held underneath.

- ▶ Variable sample quantity
- ▶ HDPE
- ▶ Clean room manufactured
- ▶ Optionally sterilised by gamma rays
- ▶ Nominal width 14 mm
- ▶ Ø 21 mm



### DispoLance

| Length mm | Model      | Pieces per pack | Price € | Quantity scale from | Scale price € | Item no.     |
|-----------|------------|-----------------|---------|---------------------|---------------|--------------|
| 300       | standard   | 20              | 81.60   | 10                  | 77.50         | 5393-5560 N4 |
| 300       | sterilized | 20              | 93.60   | 10                  | 88.90         | 5393-5561 N4 |
| 500       | standard   | 20              | 98.40   | 10                  | 93.50         | 5393-5570 N4 |
| 500       | sterilized | 20              | 110.40  | 10                  | 104.90        | 5393-5571 N4 |

### Accessories

#### Description

Sampling bag SteriBag see page 132

## MicroDispo

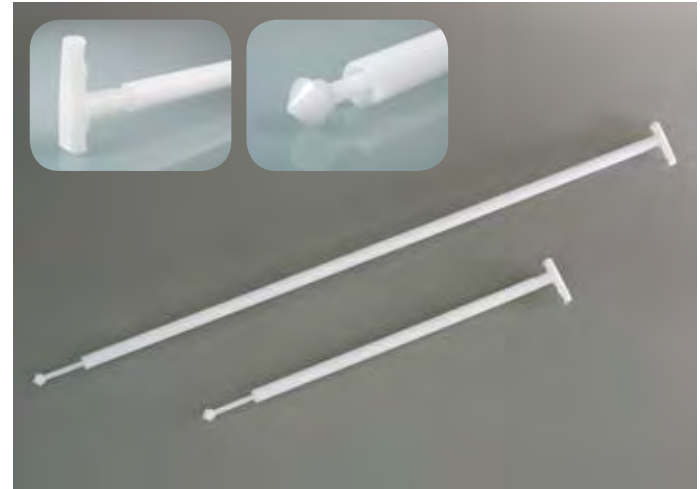

Quite small sample quantities (10 ml) can be taken with MicroDispo. Especially in pharmaceutical applications it often happens that only a small quantity can or should be extracted for analysis. Using the disposable sampler, precise target point samples can be taken of free-flowing powders and small-grain bulk materials.

- ▶ Ergonomic handle
- ▶ HDPE
- ▶ Clean room manufactured
- ▶ Optionally sterilised by gamma rays
- ▶ Ø 21 mm



### MicroDispo

| Length mm | Volume ml | Model      | Pieces per pack | Price € | Quantity scale from | Scale price € | Item no.     |
|-----------|-----------|------------|-----------------|---------|---------------------|---------------|--------------|
| 500       | 10        | standard   | 20              | 117.20  | 10                  | 111.30        | 5393-2240 N4 |
| 500       | 10        | sterilized | 20              | 135.90  | 10                  | 129.10        | 5393-2241 N4 |
| 1000      | 10        | standard   | 20              | 143.90  | 10                  | 136.70        | 5393-2250 N4 |
| 1000      | 10        | sterilized | 20              | 178.50  | 10                  | 169.60        | 5393-2251 N4 |

# MultiDispo



Disposable zone samplers for taking samples from multiple layers of the sample material. Suitable for free-flowing powders and small-grain granulates. The representative all-layer sample can be emptied directly through the open handle into a sample container.

- ▶ Easy emptying through the opening in the handle (Ø 14 mm)
- ▶ HDPE
- ▶ Clean room manufactured
- ▶ Optionally sterilised by gamma rays
- ▶ Ø 25 mm



## MultiDispo

| Length mm | Volume ml | Model      | Pieces per pack | Price € | Quantity scale from | Scale price € | Item no.     |
|-----------|-----------|------------|-----------------|---------|---------------------|---------------|--------------|
| 500       | 100       | standard   | 20              | 172.50  | 10                  | 163.90        | 5393-4440 N4 |
| 500       | 100       | sterilized | 20              | 191.40  | 10                  | 181.80        | 5393-4441 N4 |
| 1000      | 200       | standard   | 20              | 209.70  | 10                  | 199.20        | 5393-4450 N4 |
| 1000      | 200       | sterilized | 20              | 229.00  | 10                  | 217.60        | 5393-4451 N4 |





## TargetDispo



TargetDispo is used to take a target point sample at a position in the sample material that has previously been precisely determined. The sampler pierces into the powder or granulate while closed. When it reaches the sample removal point it is opened and then closed again. In this way a precise target-point sample is obtained. The sample can simply be emptied through the open handle.

- ▶ Easy emptying through the opening in the handle (Ø 14 mm)
- ▶ HDPE
- ▶ Clean room manufactured
- ▶ Optionally sterilised by gamma rays
- ▶ Ø 25 mm



| TargetDispo |           |            |                 |         |                     |               |           |    |  |  |
|-------------|-----------|------------|-----------------|---------|---------------------|---------------|-----------|----|--|--|
| Length mm   | Volume ml | Model      | Pieces per pack | Price € | Quantity scale from | Scale price € | Item no.  |    |  |  |
| 500         | 100       | standard   | 20              | 149.80  | 10                  | 142.30        | 5393-4460 | N4 |  |  |
| 500         | 100       | sterilized | 20              | 164.90  | 10                  | 156.70        | 5393-4461 | N4 |  |  |
| 1000        | 200       | standard   | 20              | 181.50  | 10                  | 172.40        | 5393-4470 | N4 |  |  |
| 1000        | 200       | sterilized | 20              | 199.70  | 10                  | 189.70        | 5393-4471 | N4 |  |  |

## ZoneDispo



The ZoneDispo disposable all-layer sampler is used in sampling to collect a representative all-layer sample from three different layers. Suitable for free-flowing powders and small-grain granulates. The collected sample can be secured and transported in the closed sampler.

- ▶ HDPE
- ▶ Clean room manufactured
- ▶ Optionally sterilised by gamma rays
- ▶ Ø 25 mm



| ZoneDispo |           |            |                 |         |                     |               |           |    |  |  |
|-----------|-----------|------------|-----------------|---------|---------------------|---------------|-----------|----|--|--|
| Length mm | Volume ml | Model      | Pieces per pack | Price € | Quantity scale from | Scale price € | Item no.  |    |  |  |
| 500       | 100       | standard   | 20              | 156.80  | 10                  | 149.00        | 5393-4420 | N4 |  |  |
| 500       | 100       | sterilized | 20              | 174.00  | 10                  | 165.30        | 5393-4421 | N4 |  |  |
| 1000      | 200       | standard   | 20              | 185.00  | 10                  | 175.80        | 5393-4430 | N4 |  |  |
| 1000      | 200       | sterilized | 20              | 208.00  | 10                  | 197.60        | 5393-4431 | N4 |  |  |

## SteriPlast® from Bürkle



### SteriPlast

Bürkle SteriPlast® products – scoops, spatulas and spoons – are high-quality, ergonomically shaped disposable products that are specially designed and optimised for sampling purposes. They are produced, assembled and individually packed in Bürkle's own clean room and then sterilised by gamma rays (min. 10 kGy).



**The SteriPlast® products thus meet all the requirements for absolutely sterile sampling with first class certification.**



Clean room production

### SteriPlast Bio

SteriPlast® bio-products are only manufactured with renewable raw materials and then also sterilised by gamma rays (min. 10 kGy). To create a completely sustainable product, the individual packaging is also made of bio-PE. This is 100 % recyclable and is manufactured without fossil raw materials. This also involves a CO<sub>2</sub> saving as well as a reduction of the greenhouse effect.



Individually packed



Gamma ray sterilised

**The highest purity and ecological sustainability combined perfectly!**

## SteriPlast® Bio sample scoop



The SteriPlast® Bio sample scoop made of green PE is produced in our clean room of class 7 (10,000), individually packaged in bio-PE film for disposable use and then sterilised by gamma rays. Green PE bio-plastic has all the suitable properties of conventional polyethylene but is manufactured from renewable raw materials and can be completely recycled.

The sample scoop is ideal for powders, granulates and pastes.

- ▶ Product and packaging made of renewable raw materials
- ▶ Green PE, white
- ▶ Individually packaged and sterilised by gamma rays
- ▶ Production and packaging according to clean room class 7
- ▶ With EU foodstuffs and FDA approval

### SteriPlast® Bio sample scoop

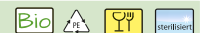

| Capacity ml | Length mm | Pieces per pack | Price € | Quantity scale from | Scale price € | Item no.     |
|-------------|-----------|-----------------|---------|---------------------|---------------|--------------|
| 25          | 141       | 10              | 16,40   | 10                  | 15,10         | 5379-1001 N4 |
| 50          | 160       | 10              | 16,95   | 10                  | 15,60         | 5379-1003 N4 |
| 100         | 205       | 10              | 17,50   | 10                  | 16,10         | 5379-1005 N4 |
| 150         | 216       | 10              | 17,90   | 10                  | 16,45         | 5379-1007 N4 |

## SteriPlast® sample scoop

The SteriPlast® sample scoop made of polystyrene is produced and assembled in our clean room of class 7 (10,000), individually packaged for disposable use and then sterilised by gamma rays.

The sample scoop is ideal for powders, granulates and pastes.

The scoop with transparent cover can be closed immediately after sampling and the sterility and exclusion of contamination can therefore be safeguarded.

- ▶ PS, white
- ▶ Individually packaged and sterilised by gamma rays
- ▶ Production, assembly and packaging according to clean room class 7
- ▶ With EU foodstuffs and FDA approval



Ergonomics were particularly important to us for the design of the sample scoop. The scoop stands horizontally due to the special handle design and the slightly angled front edge and can therefore be put down without the sample material trickling out.

### SteriPlast® sample scoop

| Capacity ml | Model         | Length mm | Pieces per pack | Price € | Quantity scale from | Scale price € | Item no.  |    |
|-------------|---------------|-----------|-----------------|---------|---------------------|---------------|-----------|----|
| 25          | without cover | 141       | 10              | 14.90   | 10                  | 13.70         | 5378-1001 | N4 |
| 25          | with cover    | 142       | 10              | 22.65   | 10                  | 20.85         | 5378-1002 | N4 |
| 50          | without cover | 160       | 10              | 15.40   | 10                  | 14.15         | 5378-1003 | N4 |
| 50          | with cover    | 161       | 10              | 23.30   | 10                  | 21.45         | 5378-1004 | N4 |
| 100         | without cover | 205       | 10              | 15.90   | 10                  | 14.65         | 5378-1005 | N4 |
| 100         | with cover    | 206       | 10              | 23.95   | 10                  | 22.05         | 5378-1006 | N4 |
| 150         | without cover | 216       | 10              | 16.30   | 10                  | 15.00         | 5378-1007 | N4 |
| 150         | with cover    | 218       | 10              | 24.50   | 10                  | 22.55         | 5378-1008 | N4 |
| 250         | without cover | 232       | 10              | 19.90   | 10                  | 18.30         | 5378-1013 | N4 |
| 250         | with cover    | 235       | 10              | 33.85   | 10                  | 31.15         | 5378-1014 | N4 |
| 500         | without cover | 280       | 10              | 35.20   | 10                  | 32.40         | 5378-1015 | N4 |
| 500         | with cover    | 283       | 10              | 59.85   | 10                  | 55.05         | 5378-1016 | N4 |



## SteriPlast® sample spatula



The SteriPlast® sample spatula made of polystyrene is produced and assembled in our clean room of class 7 (10,000), individually packaged for disposable use and then sterilised by gamma rays. As a result of the long, ergonomically-shaped, stable handle and a sharp blade, it is possible to even penetrate directly into containers such as paper or plastic sacks. The sample spatula is ideal for sampling powders, granulates and pastes. The scoop with transparent sealing sleeve can be closed again immediately after sampling and the exclusion of contamination can be safeguarded for the sterile sample taken.

- ▶ PS, white
- ▶ Individually packaged and sterilised by gamma rays
- ▶ Production, assembly and packaging according to clean room class 7
- ▶ With EU foodstuffs and FDA approval

| SteriPlast® sample spatula |                 |                    |                 |         |                     |               |           |    |  |
|----------------------------|-----------------|--------------------|-----------------|---------|---------------------|---------------|-----------|----|--|
| Model                      | Total length mm | Insertion depth mm | Pieces per pack | Price € | Quantity scale from | Scale price € | Item no.  |    |  |
| without sleeve             | 263             | 150                | 10              | 13.45   | 10                  | 12.10         | 5378-1009 | N4 |  |
| with sleeve                | 268             | 150                | 10              | 20.20   | 10                  | 18.20         | 5378-1010 | N4 |  |

## SteriPlast® Bio sample spatula



The SteriPlast® Bio sample spatula made of green PE is produced in our clean room of class 7 (10,000), individually packaged in bio-PE film for disposable use and then sterilised by gamma rays. Green PE bio-plastic has all the suitable properties of conventional polyethylene and can be completely recycled but is manufactured from renewable raw materials. As a result of the long, ergonomically-shaped, stable handle and a sharp blade, it is possible to even penetrate directly into containers such as paper or plastic sacks. The sample spatula is ideal for sampling powders, granulates and pastes.

- ▶ Product and packaging made of renewable raw materials
- ▶ Green PE, white
- ▶ Individually packaged and sterilised by gamma rays
- ▶ Production and packaging according to clean room class 7
- ▶ With EU foodstuffs and FDA approval

| SteriPlast® Bio sample spatula |                    |                 |         |                     |               |           |    |  |  |
|--------------------------------|--------------------|-----------------|---------|---------------------|---------------|-----------|----|--|--|
| Total length mm                | Insertion depth mm | Pieces per pack | Price € | Quantity scale from | Scale price € | Item no.  |    |  |  |
| 263                            | 150                | 10              | 14.80   | 10                  | 13.30         | 5379-1009 | N4 |  |  |

## SteriPlast® sample spoon



The SteriPlast® sample spoon made of polystyrene is produced in our clean room of class 7 (10,000), individually packaged for disposable use and then sterilised by gamma rays. The sample spoon is available in two sizes, 2.5 ml (similar to a tea-spoon) and 10 ml (similar to a tablespoon), and is ideal for sampling powders, granulates and fluids.

- ▶ PS, white
- ▶ Individually packaged and sterilised by gamma rays
- ▶ Production and packaging according to clean room class 7
- ▶ With EU foodstuffs and FDA approval

### SteriPlast® sample spoon

| Length mm | Capacity ml | Pieces per pack | Price € | Quantity scale from | Scale price € | Item no.     |
|-----------|-------------|-----------------|---------|---------------------|---------------|--------------|
| 127       | 2,5         | 100             | 32.30   | 10                  | 30.35         | 5378-1011 N4 |
| 170       | 10          | 100             | 34.40   | 10                  | 32.35         | 5378-1012 N4 |

## SteriPlast® Bio sample spoon



The SteriPlast® Bio sample spoon made of green PE is produced in our clean room of class 7 (10,000), individually packaged in bio-PE film for disposable use and then sterilised by gamma rays. Green PE bio-plastic has all the suitable properties of conventional polyethylene but is manufactured from renewable raw materials and can be completely recycled.

The sample spoon is available in two sizes, 2.5 ml (similar to a tea-spoon) and 10 ml (similar to a tablespoon), and is ideal for sampling powders, granulates and fluids.

- ▶ Product and packaging made of renewable raw materials
- ▶ Green PE, white
- ▶ Individually packaged and sterilised by gamma rays
- ▶ Production and packaging according to clean room class 7
- ▶ With EU foodstuffs and FDA approval

### SteriPlast® Bio sample spoon

| Length mm | Capacity ml | Pieces per pack | Price € | Quantity scale from | Scale price € | Item no.     |
|-----------|-------------|-----------------|---------|---------------------|---------------|--------------|
| 127       | 2,5         | 100             | 37.15   | 10                  | 34.90         | 5379-1011 N4 |
| 170       | 10          | 100             | 39.55   | 10                  | 37.20         | 5379-1012 N4 |

## Sampling bag SteriBag | the sterilised packaging bag

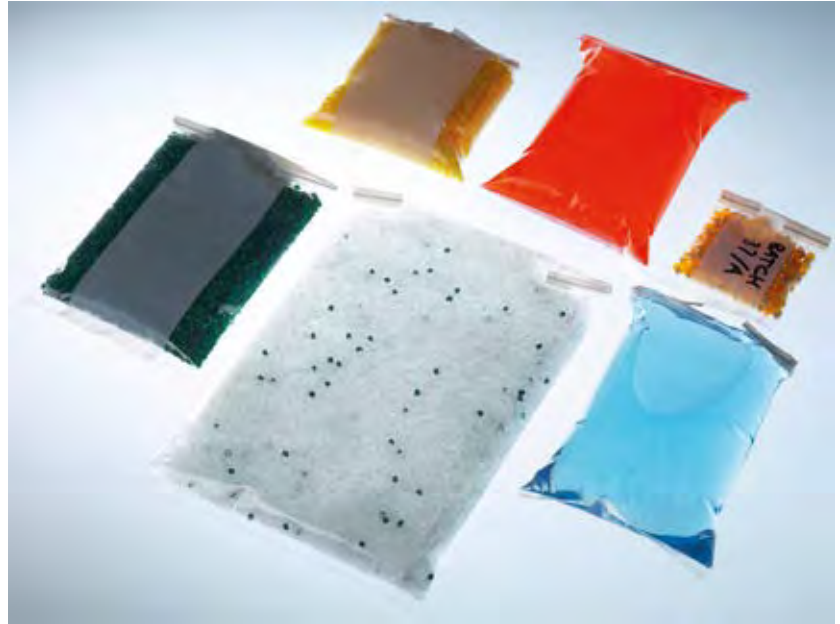
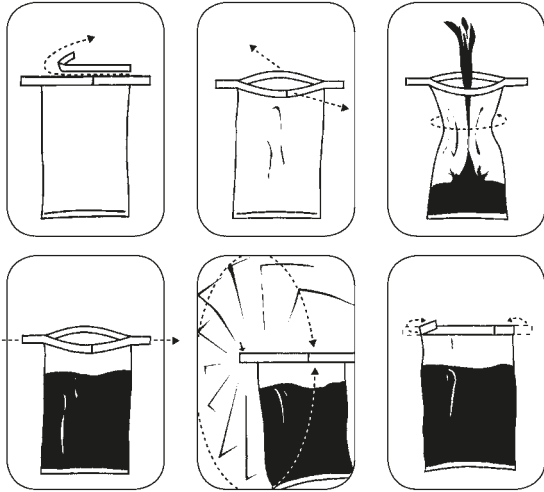

The sterilised sampling bag SteriBag for samples in chemistry, pharmaceuticals, medicine, veterinary science and foodstuffs etc.

The bags are made of polyethylene and are therefore exceptionally tearproof and leakproof.

The SteriBag sampling bag is distinguished by its safe handling. When used according to instructions, samples are guaranteed sterile.

Integrated safety: The tab-ends are sealed in plastic film to prevent skin injuries.

- ▶ Sterilised
- ▶ Can be labelled
- ▶ Leakproof
- ▶ Save space
- ▶ Transparent
- ▶ With practical closure to tear-open
- ▶ Proven millions of times

**Bulk prices**

### Sampling bag SteriBag

| Capacity ml | Model                  | L x W mm  | Pieces per pack | Price € | Quantity scale from | Scale price € | Item no.  |    |
|-------------|------------------------|-----------|-----------------|---------|---------------------|---------------|-----------|----|
| 60          | without labelling area | 127 x 76  | 500             | 112.50  | 6                   | 106.55        | 5344-0060 | N3 |
| 60          | with labelling area    | 127 x 76  | 500             | 122.25  | 6                   | 116.20        | 5344-0061 | N3 |
| 150         | without labelling area | 178 x 76  | 500             | 116.20  | 6                   | 108.90        | 5344-0180 | N3 |
| 150         | with labelling area    | 178 x 76  | 500             | 125.90  | 6                   | 119.75        | 5344-0181 | N3 |
| 450         | without labelling area | 229 x 114 | 500             | 136.70  | 6                   | 130.70        | 5344-0540 | N3 |
| 450         | with labelling area    | 229 x 114 | 500             | 145.15  | 6                   | 136.70        | 5344-0541 | N3 |
| 650         | without labelling area | 229 x 140 | 500             | 152.45  | 6                   | 143.95        | 5344-0720 | N3 |
| 650         | with labelling area    | 229 x 140 | 500             | 174.20  | 6                   | 166.95        | 5344-0721 | N3 |
| 900         | without labelling area | 305 x 114 | 500             | 158.55  | 6                   | 151.25        | 5344-0810 | N3 |
| 900         | with labelling area    | 305 x 114 | 500             | 168.15  | 6                   | 159.75        | 5344-0811 | N3 |
| 1650        | without labelling area | 305 x 178 | 250             | 121.00  | 12                  | 116.20        | 5344-1650 | N3 |
| 1650        | with labelling area    | 305 x 178 | 250             | 136.70  | 12                  | 125.90        | 5344-1651 | N3 |

## SteriBag StandUp sample bag

SteriBag StandUp is a sterile sample bag with a stand-up base. The special bottom unfolds as soon as the bag is filled. This makes SteriBag StandUp stable and able to stand on its own without a separate stand or support, leaving both your hands free to take the sample and fill the bag. The wire bracket at the closure keeps the bag open, making it easy and convenient to fill.

The sample bag is the ideal space-saving, unbreakable, inexpensive and sterile replacement for bottles and beakers.

Can be used for samples available as liquids, powders, solids and pastes; suitable for foods and can be frozen.

The stable standing SteriBag StandUp sample bag is easy and safe to transport.

SteriBag StandUp, the sample bag for easy handling of samples.

- ▶ Stands stably
- ▶ Protected against discharge
- ▶ Sterilised
- ▶ With labelling field



**Bulk prices**

### SteriBag StandUp sample bag

| Capacity ml | L x W mm | Pieces per pack | Price € | Quantity scale from | Scale price € | Item no.     |
|-------------|----------|-----------------|---------|---------------------|---------------|--------------|
| 400         | 229x114  | 500             | 179.25  | 5                   | 170.25        | 5344-0400 N3 |
| 600         | 229x152  | 500             | 187.35  | 5                   | 177.95        | 5344-0600 N3 |



## SteriPlast® sampling tube



**b** SteriPlast

Sterile sampling tube with removable handle and tightly closing sealing cover. The lid can be opened with one hand and is then at a 90° angle. Liquid/condensate in the lid goes into an absorbing channel integrated into the lid, nothing is lost, nothing can drip. The sterile sampling tube with a handle of 24 cm in length enables a clean sample to be placed directly in the sampling container. This mainly prevents cross-contamination.

- ▶ Polypropylene, blue transparent
- ▶ Sterile, packed separately

**\* Bulk prices**

### SteriPlast® sampling tube

| Capacity ml | Dia. mm | Height mm | Price € | Quantity scale from | Scale price € | Item no.  |    |
|-------------|---------|-----------|---------|---------------------|---------------|-----------|----|
| 90          | 43      | 80        | 3.28    | 150                 | 2.91          | 6206-0101 | N3 |

## SteriPlast® syringe



The syringe is used to take sterile samples and store them. The sample amount can be read off from the printed contents graduation. The syringe is supplied in a sterile package and is ready for immediate use. The syringe can be extended to any length with additional tubing. A Luer adapter is supplied for the 100 ml syringe.

- ▶ PP, transparent
- ▶ Contents graduation
- ▶ Sterilised, packed separately

**b** SteriPlast

**\* Bulk prices**

### SteriPlast® syringe

| Capacity ml | Pieces per pack | Division ml | Price € | Quantity scale from | Scale price € | Item no.  |    |
|-------------|-----------------|-------------|---------|---------------------|---------------|-----------|----|
| 50          | 10              | 1           | 17.40   | 6                   | 15.75         | 5325-0060 | N4 |
| 100         | 10              | 2           | 52.00   | 5                   | 44.25         | 5325-0100 | N4 |



## PharmaSpoon | for ultrapure sampling



PharmaSpoon for taking samples of powdery substances, intermediate products and material in the pharmaceutical industry. Special materials with excellent surface qualities must be used for this to prevent cross-contamination. Our PharmaSpoon fulfils these requirements. Made of stainless steel V4A (1.4404), surface highly polished by hand (not electro-polished!). The excellent surface properties of the PharmaSpoon provide significant advantages.

- ▶ Possible residues are even visible in the trace sector ( $\mu\text{g}$  sector)
- ▶ The surface is easy to clean
- ▶ The PharmaSpoon is also suitable for sterile sampling

**i** The PharmaSpoon was developed by an internationally known pharmaceutical company in Basel, Switzerland, and its usefulness has been confirmed in actual practice.

| PharmaSpoon     |         |                     |               |              |
|-----------------|---------|---------------------|---------------|--------------|
| Total length mm | Price € | Quantity scale from | Scale price € | Item no.     |
| 650             | 463.45  | 5                   | 370.75        | 5324-0001 N2 |

## Sample-spoon



Sampling spoon for withdrawing small quantities of samples. This specially shaped spoon lets you reach almost every corner in a container and prevents samples from trickling out.

- ▶ Made of AISI 304 (1.4301) stainless steel
- ▶ Largely chemical resistant (not against acids and alkalis)

| Sample-spoon |         |                     |               |              |
|--------------|---------|---------------------|---------------|--------------|
| Length mm    | Price € | Quantity scale from | Scale price € | Item no.     |
| 150          | 12.90   | 10                  | 11.70         | 5320-0150 N4 |
| 180          | 18.85   | 10                  | 17.00         | 5320-0180 N4 |
| 210          | 29.60   | 10                  | 26.90         | 5320-0210 N4 |
| 300          | 35.80   | 10                  | 32.70         | 5320-0300 N4 |
| 400          | 39.00   | 10                  | 35.50         | 5320-0400 N4 |

## Scoop AISI 304



- ▶ Stainless steel V2A (1.4301)
- ▶ Sterilisable
- ▶ Robust

## EasyScoop



When sampling bulk goods with a high specific weight, conventional scoops subject the user's wrist to great stress. EasyScoop with its centrally arranged inner grip is ergonomically designed and ensures easy and safe work. As EasyScoop is considerably shorter than conventional scoops, it is easier to take samples from narrow containers.

- ▶ Made of light aluminium, bright-anodised

### Scoop AISI 304

| Capacity ml | Dia. mm | Price € | Quantity scale from | Scale price € | Item no.  |  |  |  |
|-------------|---------|---------|---------------------|---------------|-----------|---|---|---|
| 120         | 50      | 20.10   | 5                   | 20.00         | 5370-0120 | N3  |   |   |
| 450         | 75      | 22.65   | 5                   | 22.10         | 5370-0450 | N3  |   |   |
| 1000        | 100     | 26.95   | 5                   | 24.85         | 5370-1000 | N3  |   |   |
| 1500        | 120     | 30.85   | 5                   | 28.75         | 5370-1500 | N3  |   |   |
| 2500        | 150     | 40.50   | 5                   | 40.00         | 5370-2000 | N3  |   |   |

### EasyScoop

| Capacity ml | Length mm | Weight g | Price € | Item no.  |  |
|-------------|-----------|----------|---------|-----------|---|
| 1500        | 200       | 325      | 24.85   | 5356-1500 | N2  |
| 2000        | 300       | 575      | 32.70   | 5356-2000 | N2  |

## FoodScoop



Very stable hand scoop for various applications, particularly suited for the food industry. Seamless connection of scoop and hollow handle, therefore without crevices and edges. Especially smooth, highly polished surface.

- ▶ Especially sturdy model
- ▶ Stainless steel V2A (1.4301)
- ▶ With handy suspension eyelet

| FoodScoop   |                 |           |         |                     |               |              |  |  |  |
|-------------|-----------------|-----------|---------|---------------------|---------------|--------------|--|--|--|
| Capacity ml | Total length mm | L x W mm  | Price € | Quantity scale from | Scale price € | Item no.     |  |  |  |
| 100         | 215             | 120 x 60  | 19.95   | 5                   | 18.30         | 5371-0100 N3 |  |  |  |
| 200         | 230             | 140 x 75  | 27.20   | 5                   | 24.95         | 5371-0200 N3 |  |  |  |
| 250         | 245             | 155 x 85  | 30.00   | 5                   | 27.70         | 5371-0250 N3 |  |  |  |
| 350         | 290             | 180 x 100 | 33.70   | 5                   | 30.95         | 5371-0350 N3 |  |  |  |
| 500         | 350             | 220 x 130 | 44.55   | 5                   | 40.90         | 5371-0500 N3 |  |  |  |

## PharmaScoop



This sample scoop has been developed in order to meet the high requirements of the pharmaceutical industry, such as those contained in the FDA regulations.

Like all samplers for the pharmaceutical industry, they are made of stainless steel V4A without edges, crevices or undercuts in which sample residues could collect and contaminate subsequent samples. The highly polished inner and outer surfaces of the scoop therefore meet all the requirements for GMP compliance in production and sampling.

- ▶ Stainless steel V4A (1.4401)
- ▶ GMP conform
- ▶ Highly polished

| PharmaScoop |         |           |         |              |  |  |  |  |
|-------------|---------|-----------|---------|--------------|--|--|--|--|
| Capacity ml | Dia. mm | Length mm | Price € | Item no.     |  |  |  |  |
| 10          | 25      | 45        | 59.10   | 5324-0010 N2 |  |  |  |  |
| 50          | 38      | 70        | 100.10  | 5324-0011 N2 |  |  |  |  |
| 100         | 50      | 100       | 136.00  | 5324-0012 N2 |  |  |  |  |
| 500         | 95      | 140       | 136.55  | 5324-0018 N2 |  |  |  |  |
| 750         | 95      | 210       | 140.65  | 5324-0013 N2 |  |  |  |  |
| 1000        | 110     | 235       | 155.65  | 5324-0014 N2 |  |  |  |  |
| 1250        | 125     | 195       | 160.55  | 5324-0015 N2 |  |  |  |  |
| 1700        | 135     | 230       | 166.80  | 5324-0016 N2 |  |  |  |  |
| 2500        | 185     | 215       | 198.95  | 5324-0017 N2 |  |  |  |  |

# Stainless steel measuring spoons



Stainless steel measuring spoon in a set of 4, as a measuring aid for fast and easy measuring from 1.25 to 15 ml. The volume is engraved on the handle of each measuring spoon.

- ▶ Stainless steel V2A (1.4301)
- ▶ Volumes: 1.25 ml, 2.5 ml, 5 ml, 15 ml
- ▶ Spoon high-gloss finished, handle matt polished

## Stainless steel measuring spoons

|             |         |                     |               |              |
|-------------|---------|---------------------|---------------|--------------|
| Capacity ml | Price € | Quantity scale from | Scale price € | Item no.     |
| 1,25 - 15   | 11.50   | 10                  | 10.00         | 5334-8000 N4 |



## Volumetric spoons



The capacity is printed on the spoon handle. Available as a set with 8 volumetric spoons or separate in bags of 100 volumetric spoons.

- ▶ Polystyrene, blue
- ▶ Round shape, easy emptying

| Volumetric spoons |             |                 |         |                     |               |           |    |  |
|-------------------|-------------|-----------------|---------|---------------------|---------------|-----------|----|--|
| Model             | Capacity ml | Pieces per pack | Price € | Quantity scale from | Scale price € | Item no.  |    |  |
| set with 8 spoons | 0,5 - 50    | 8               | 7.50    | 10                  | 6.80          | 5334-0001 | N4 |  |
| pack              | 0,5         | 100             | 39.70   | 10                  | 35.70         | 5334-0005 | N4 |  |
| pack              | 1           | 100             | 39.70   | 10                  | 35.70         | 5334-0010 | N4 |  |
| pack              | 2,5         | 100             | 45.15   | 10                  | 40.65         | 5334-0025 | N4 |  |
| pack              | 5           | 100             | 46.45   | 10                  | 41.80         | 5334-0050 | N4 |  |
| pack              | 10          | 100             | 46.75   | 10                  | 42.00         | 5334-0100 | N4 |  |
| pack              | 15          | 100             | 49.80   | 10                  | 44.90         | 5334-0150 | N4 |  |
| pack              | 25          | 100             | 55.05   | 10                  | 49.55         | 5334-0250 | N4 |  |
| pack              | 50          | 100             | 86.15   | 10                  | 77.20         | 5334-0500 | N4 |  |

## Measuring scoops



Universal graduated shovel for filling and measuring of powders and granules. For exact metering, the graduated shovel is to be overfilled and the excess at the upper edge of the shovel is to be wiped off.

- ▶ PP, white
- ▶ High chemical-resistance
- ▶ Calibrated volume when full to the brim

| Measuring scoops |           |         |                     |               |           |    |  |
|------------------|-----------|---------|---------------------|---------------|-----------|----|--|
| Capacity ml      | L x W mm  | Price € | Quantity scale from | Scale price € | Item no.  |    |  |
| 2                | 60 x 21   | 0.35    | 48                  | 0.34          | 9614-0002 | N3 |  |
| 5                | 82 x 27   | 0.41    | 48                  | 0.38          | 9614-0005 | N3 |  |
| 10               | 100 x 34  | 0.44    | 48                  | 0.43          | 9614-0010 | N3 |  |
| 25               | 135 x 44  | 0.66    | 48                  | 0.60          | 9614-0025 | N3 |  |
| 50               | 160 x 55  | 0.97    | 48                  | 0.88          | 9614-0050 | N3 |  |
| 100              | 200 x 70  | 1.46    | 48                  | 1.33          | 9614-0100 | N3 |  |
| 250              | 260 x 90  | 3.14    | 24                  | 2.84          | 9614-0250 | N3 |  |
| 500              | 315 x 118 | 4.75    | 24                  | 4.27          | 9614-0500 | N3 |  |
| 1000             | 385 x 134 | 5.55    | 24                  | 5.00          | 9614-1000 | N3 |  |

# LaboPlast® from Bürkle – the quality brand for laboratories and science

LaboPlast® is the Bürkle brand for high-quality plastic products that have been specially designed and developed to optimally meet the demanding and in part special requirements in laboratories, industry and science. Here LaboPlast® stands for the best quality, excellent craftsmanship and outstanding material properties.

**Test the products and get to know and appreciate our LaboPlast® product lines!**

LaboPlast® bio-products are only manufactured from renewable raw materials. To create a completely sustainable product, the individual packaging is also made of bio-PE. This is 100 % recyclable and is manufactured without fossil raw materials. This also involves a CO<sub>2</sub> saving as well as a reduction of the greenhouse effect.

**The highest quality and ecological sustainability combined perfectly!**



## LaboPlast® scoop, disposable



The LaboPlast® disposable scoop made of polystyrene is produced and assembled in our clean room of class 7 (10,000) and individually packaged for disposable use.

The disposable scoop is ideal for powders, granulates and pastes.

The scoop with transparent cover can be closed immediately after sampling and the exclusion of contamination can therefore be safeguarded.

- ▶ PS, white
- ▶ Individually packaged
- ▶ Production, assembly and packaging according to clean room class 7
- ▶ With EU foodstuffs and FDA approval

LaboPlast® scoop, disposable

| Ca-<br>pacity<br>ml | Model         | Length<br>mm | Pieces<br>per pack | Price € | Quantity<br>scale from | Scale<br>price € | Item no.  |    |  |
|---------------------|---------------|--------------|--------------------|---------|------------------------|------------------|-----------|----|--|
| 25                  | without cover | 141          | 10                 | 13.70   | 10                     | 12.60            | 5378-0001 | N4 |  |
| 25                  | with cover    | 142          | 10                 | 21.40   | 10                     | 19.70            | 5378-0002 | N4 |  |
| 50                  | without cover | 160          | 10                 | 14.15   | 10                     | 13.00            | 5378-0003 | N4 |  |
| 50                  | with cover    | 161          | 10                 | 22.05   | 10                     | 20.30            | 5378-0004 | N4 |  |
| 100                 | without cover | 205          | 10                 | 14.65   | 10                     | 13.50            | 5378-0005 | N4 |  |
| 100                 | with cover    | 206          | 10                 | 22.70   | 10                     | 20.90            | 5378-0006 | N4 |  |
| 150                 | without cover | 216          | 10                 | 15.00   | 10                     | 13.80            | 5378-0007 | N4 |  |
| 150                 | with cover    | 218          | 10                 | 23.20   | 10                     | 21.35            | 5378-0008 | N4 |  |
| 250                 | without cover | 232          | 10                 | 18.30   | 10                     | 16.85            | 5378-0013 | N4 |  |
| 250                 | with cover    | 235          | 10                 | 31.10   | 10                     | 28.65            | 5378-0014 | N4 |  |
| 500                 | without cover | 280          | 10                 | 32.40   | 10                     | 29.80            | 5378-0015 | N4 |  |
| 500                 | with cover    | 283          | 10                 | 55.10   | 10                     | 50.70            | 5378-0016 | N4 |  |

## LaboPlast® Bio scoop



The LaboPlast® Bio disposable scoop made of green PE is produced in our clean room of class 7 (10,000) and individually packaged in bio-PE film for disposable use.

Green PE bio-plastic has all the suitable properties of conventional polyethylene but is manufactured from renewable raw materials and can be completely recycled.

- ▶ Product and packaging made of renewable raw materials
- ▶ Bio-PE, white
- ▶ Individually packaged
- ▶ Production and packaging according to clean room class 7
- ▶ With EU foodstuffs and FDA approval

LaboPlast® Bio scoop

| Capacity ml | Length mm | Pieces per<br>pack | Price € | Quantity<br>scale from | Scale<br>price € | Item no.  |    |  |  |
|-------------|-----------|--------------------|---------|------------------------|------------------|-----------|----|--|--|
| 25          | 141       | 10                 | 15.10   | 10                     | 13.90            | 5379-0001 | N4 |  |  |
| 50          | 160       | 10                 | 15.60   | 10                     | 14.35            | 5379-0003 | N4 |  |  |
| 100         | 205       | 10                 | 16.10   | 10                     | 14.80            | 5379-0005 | N4 |  |  |
| 150         | 216       | 10                 | 16.50   | 10                     | 15.20            | 5379-0007 | N4 |  |  |

## LaboPlast® spatula, disposable



The LaboPlast® disposable spatula made of polystyrene is produced and assembled in our clean room of class 7 (10,000) and individually packaged for disposable use.

As a result of the long, ergonomically-shaped, stable handle and a sharp blade, it is possible to even penetrate directly into containers such as paper or plastic sacks. The disposable spatula is ideal for sampling powders, granulates and pastes.

The spatula with transparent sealing sleeve can be closed again immediately after sampling and the exclusion of contamination can be safeguarded for the sample taken.

- ▶ PS, white
- ▶ Individually packaged
- ▶ Production, assembly and packaging according to clean room class 7
- ▶ With EU foodstuffs and FDA approval

### LaboPlast® spatula, disposable

| Model          | Total length mm | Insertion depth mm | Pieces per pack | Price € | Quantity scale from | Scale price € | Item no.  |    |
|----------------|-----------------|--------------------|-----------------|---------|---------------------|---------------|-----------|----|
| without sleeve | 263             | 150                | 10              | 12.35   | 10                  | 11.10         | 5378-0009 | N4 |
| with sleeve    | 268             | 150                | 10              | 19.10   | 10                  | 17.20         | 5378-0010 | N4 |



## LaboPlast® Bio spatula



The LaboPlast® Bio disposable spatula made of green PE is produced in our clean room of class 7 (10,000) and individually packaged in bio-PE film for disposable use.

Green PE bio-plastic has all the suitable properties of conventional polyethylene and can be completely recycled but is manufactured from renewable raw materials.

As a result of the long, ergonomically-shaped, stable handle and a sharp blade, it is possible to even penetrate directly into containers such as paper or plastic sacks. The spatula is ideal for sampling powders, granulates and pastes.

- ▶ Product and packaging made of renewable raw materials
- ▶ Green PE, white
- ▶ Individually packaged
- ▶ Production and packaging according to clean room class 7
- ▶ With EU foodstuffs and FDA approval

### LaboPlast® Bio spatula

| Total length mm | Insertion depth mm | Pieces per pack | Price € | Quantity scale from | Scale price € | Item no.  |    |
|-----------------|--------------------|-----------------|---------|---------------------|---------------|-----------|----|
| 263             | 150                | 10              | 13.60   | 10                  | 12.25         | 5379-0009 | N4 |





## LaboPlast® spoon, disposable



The LaboPlast® disposable spoon made of polystyrene is produced in our clean room of class 7 (10,000) and individually packaged for disposable use.

The spoon is available in two sizes, 2.5 ml (similar to a teaspoon) and 10 ml (similar to a tablespoon), and is ideal for sampling powders, granulates and fluids.

- ▶ PS, white
- ▶ Individually packaged
- ▶ Production and packaging according to clean room class 7
- ▶ With EU foodstuffs and FDA approval

### LaboPlast® spoon, disposable

| Length mm | Capacity ml | Pieces per pack | Price € | Quantity scale from | Scale price € | Item no.  |    |  |
|-----------|-------------|-----------------|---------|---------------------|---------------|-----------|----|--|
| 127       | 2,5         | 100             | 31.00   | 10                  | 29.15         | 5378-0011 | N4 |  |
| 170       | 10          | 100             | 33.00   | 10                  | 31.00         | 5378-0012 | N4 |  |

## LaboPlast® Bio spoon



The LaboPlast® Bio disposable spoon made of green PE is produced in our clean room of class 7 (10,000) and individually packaged in bio-PE film for disposable use.

Green PE bio-plastic has all the suitable properties of conventional polyethylene but is manufactured from renewable raw materials and can be completely recycled.

The disposable spoon is available in two sizes, 2.5 ml (similar to a teaspoon) and 10 ml (similar to a tablespoon), and is ideal for sampling powders, granulates and fluids.

- ▶ Product and packaging made of renewable raw materials
- ▶ Green PE, white
- ▶ Individually packaged
- ▶ Production and packaging according to clean room class 7
- ▶ With EU foodstuffs and FDA approval

### LaboPlast® Bio spoon

| Length mm | Capacity ml | Pieces per pack | Price € | Quantity scale from | Scale price € | Item no.  |    |  |  |
|-----------|-------------|-----------------|---------|---------------------|---------------|-----------|----|--|--|
| 127       | 2,5         | 100             | 34.10   | 10                  | 32.05         | 5379-0011 | N4 |  |  |
| 170       | 10          | 100             | 36.35   | 10                  | 34.15         | 5379-0012 | N4 |  |  |

## Plastic scoops and scrapers

Iron scoops are loud, they can be dented, they rust and they are heavy. Plastic scoops have none of these disadvantages and are also hygienic because they are made in one piece and have a non-stick surface. They also have a high chemical resistance, they are unbreakable and, depending on the version, may be anti-static, anti-microbial, suitable for use with food and available in different colours (cadmium-free) – all valuable advantages!

Depending on the version the scoops may be anti-static, anti-microbial, suitable for use with food and available in different colors (cadmium-free).

The scoops and scrapers are made of polypropylene and contain additives for different applications:

- ▶ Industry: green
- ▶ Foodstuffs: white

### Six products:

- ▶ Scraper with fixed handle
- ▶ Hand scoop
- ▶ Filling scoop, ideal for sampling
- ▶ 2-part shovel with D-grip
- ▶ 2-part shovel with T-grip
- ▶ 1-part shovel reduces contamination

Pharmaceuticals, biotechnology, foods, feed, chemistry, industry, agriculture, fish farming, sampling, veterinary use.

**The shape of the food scoops corresponds to the industrial scoops on page 145.**



### Scoops and scrapers for foodstuffs

Polypropylene's easy-to-clean, smooth and pore-free surface makes these scoops extremely suitable for the food sector. The scoops can be also used for boiling products.

- ▶ For foodstuffs (FDA and (EU) Nr. 10/2011)

| ① Hand scoops for foodstuffs |                 |          |         |                     |               |              |  |  |  |  |
|------------------------------|-----------------|----------|---------|---------------------|---------------|--------------|--|--|--|--|
| L x W mm                     | Total length cm | Weight g | Price € | Quantity scale from | Scale price € | Item no.     |  |  |  |  |
| 315 x 247                    | 52,7            | 509      | 20.65   | 5                   | 18.45         | 8300-1010 N3 |  |  |  |  |

| ② Filling scoops for foodstuffs |                 |          |         |                     |               |              |  |  |  |  |
|---------------------------------|-----------------|----------|---------|---------------------|---------------|--------------|--|--|--|--|
| W x D x L mm                    | Total length cm | Weight g | Price € | Quantity scale from | Scale price € | Item no.     |  |  |  |  |
| 110 x 150 x 250                 | 25              | 90       | 5.55    | 5                   | 5.10          | 8300-5010 N3 |  |  |  |  |
| 138 x 187 x 310                 | 31              | 187      | 9.15    | 5                   | 8.35          | 8300-5011 N3 |  |  |  |  |
| 167 x 230 x 355                 | 35              | 289      | 10.15   | 5                   | 9.05          | 8300-5012 N3 |  |  |  |  |

| ⑤ 1-part shovels for foodstuffs |                  |                 |          |         |                     |               |              |  |  |  |
|---------------------------------|------------------|-----------------|----------|---------|---------------------|---------------|--------------|--|--|--|
| Handle                          | W x D x L mm     | Total length cm | Weight g | Price € | Quantity scale from | Scale price € | Item no.     |  |  |  |
| D                               | 279 x 362 x 1107 | 111             | 1564     | 77.75   | 5                   | 69.20         | 8300-0010 N3 |  |  |  |
| D                               | 347 x 410 x 1100 | 110             | 1882     | 81.65   | 5                   | 72.85         | 8300-0011 N3 |  |  |  |

  

| ③ 2-part shovel for foodstuffs |                 |                 |          |         |                     |               |              |  |  |  |
|--------------------------------|-----------------|-----------------|----------|---------|---------------------|---------------|--------------|--|--|--|
| Handle                         | W x D x L mm    | Total length cm | Weight g | Price € | Quantity scale from | Scale price € | Item no.     |  |  |  |
| T                              | 247 x 315 x 966 | 97              | 1040     | 49.40   | 5                   | 44.30         | 8300-2010 N3 |  |  |  |

| ④ Scrapers for foodstuffs |          |         |                     |               |              |  |  |  |  |  |
|---------------------------|----------|---------|---------------------|---------------|--------------|--|--|--|--|--|
| L x W mm                  | Weight g | Price € | Quantity scale from | Scale price € | Item no.     |  |  |  |  |  |
| 205 x 75                  | 44       | 5.10    | 5                   | 4.07          | 8300-4011 N3 |  |  |  |  |  |
| 250 x 110                 | 80       | 6.55    | 10                  | 5.25          | 8300-4010 N3 |  |  |  |  |  |



# Plastic scoops and scrapers

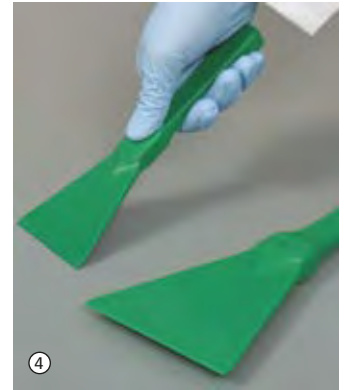
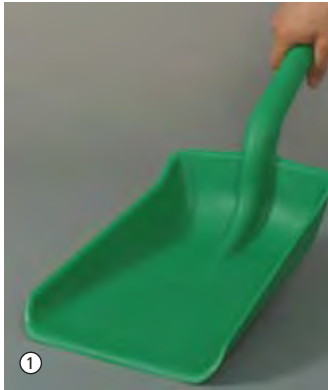



## Scoops and scrapers for industry

With anti-static additive, ideal for robust use in chemistry and industry. Polypropylene has a high resistance to chemicals and temperatures. The scoops are unbreakable, easy to clean and light-weight.



### ► Anti-static

| ① Hand shovel for industry |                 |          |         |                     |               |           |   |
|----------------------------|-----------------|----------|---------|---------------------|---------------|-----------|---|
| L x W mm                   | Total length cm | Weight g | Price € | Quantity scale from | Scale price € | Item no.  |   |
| 315 x 247                  | 51,5            | 509      | 23.65   | 5                   | 21.55         | 8300-1003 | N3  |
| 350 x 257                  | 58,7            | 810      | 37.20   | 5                   | 33.75         | 8300-1001 | N3  |



  

| ② Filling scoops for industry |                 |          |         |                     |               |           |   |
|-------------------------------|-----------------|----------|---------|---------------------|---------------|-----------|---|
| W x D x L mm                  | Total length cm | Weight g | Price € | Quantity scale from | Scale price € | Item no.  |   |
| 110 x 150 x 250               | 25              | 90       | 5.55    | 10                  | 5.10          | 8300-5001 | N3  |
| 138 x 187 x 310               | 31              | 187      | 8.65    | 5                   | 7.90          | 8300-5002 | N3  |
| 167 x 230 x 355               | 35              | 289      | 10.15   | 5                   | 9.05          | 8300-1002 | N3  |

| ③ 2-part shovel for industry |                  |                 |          |         |                     |               |   |    |
|------------------------------|------------------|-----------------|----------|---------|---------------------|---------------|---|----|
| Handle                       | W x D x L mm     | Total length cm | Weight g | Price € | Quantity scale from | Scale price € | Item no.  |    |
| T                            | 247 x 315 x 966  | 97              | 1004     | 49.40   | 5                   | 44.30         | 8300-2001   | N3 |
| D                            | 257 x 350 x 1045 | 104,5           | 1280     | 63.15   | 5                   | 55.65         | 8300-3006   | N3 |

| ④ Scrapers for industry |          |         |                     |               |           |    |   |
|-------------------------|----------|---------|---------------------|---------------|-----------|----|---|
| L x W mm                | Weight g | Price € | Quantity scale from | Scale price € | Item no.  |    |   |
| 205 x 75                | 44       | 5.10    | 10                  | 4.07          | 8300-4001 | N3 |   |
| 250 x 110               | 80       | 6.55    | 10                  | 5.25          | 8300-4002 | N3 |   |

## BeefSteaker | as per HACCP



Meat sampler for taking bacteriological samples from the surfaces of dead animals in slaughterhouses and in butchers' shops (cattle, pigs, sheep, goats and horses). The BeefSteaker is used to cut out a 25 mm round sample from the animal's skin. The stainless steel (1.4034) cutter allows the sample to be cut out easily.

The BeefSteaker can also be used for other sampling purposes (histology, medicine, food and semi-luxury articles, cheese factories, agriculture).

The BeefSteaker can be steam-sterilised or flamed. A hole in the crown prevents air compression and is used for ejecting the sample.

| BeefSteaker                |         |              |  |  |
|----------------------------|---------|--------------|--|--|
| Dia. mm                    | Price € | Item no.     |  |  |
| 25                         | 185.30  | 5388-1000 N4 |  |  |
| Accessories                |         |              |  |  |
| Description                | Price € | Item no.     |  |  |
| Transport case BeefSteaker | 10.50   | 3600-0101 N3 |  |  |

## IceSampler | for frozen, pasty materials

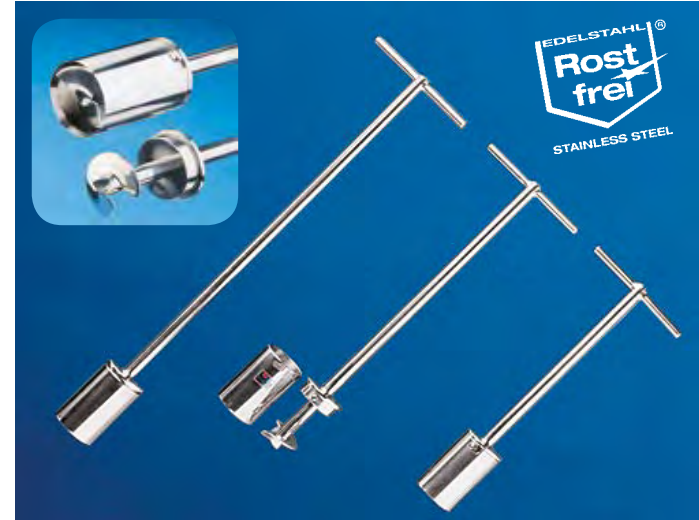

Sampler developed for sampling from frozen, highly viscous, paste-like materials such as ice-cream and similar substances. The drill-shaped cutter screws itself into the frozen goods independently when being rotated.

The collection cylinder can easily be detached via a bayonet connection. The sample is then available and can be removed.

- ▶ Stainless steel V4A (1.4404), electro-polished
- ▶ Sterilisable
- ▶ Easy cleaning
- ▶ Collection cylinder 38 mm Ø

| IceSampler |           |         |              |  |
|------------|-----------|---------|--------------|--|
| Length mm  | Volume ml | Price € | Item no.     |  |
| 300        | 50        | 396.40  | 5339-0300 N2 |  |
| 550        | 50        | 422.35  | 5339-0550 N2 |  |
| 1050       | 50        | 448.20  | 5339-1050 N2 |  |

# Ice borer | for deep-frozen and semi-solid substances



Sampler for deep-frozen and semi-solid substances products in the food industry. The sharp sawing crown of the very robust hollow borer rapidly cuts into the sample. A cylindrical sample (cross-sectional sample) of up to 20 cm can be cut out. Ice borer consisting of three parts: Borer, borer head for use in conventional drills and rod for pressing the cylindrical sample out of the borer head.

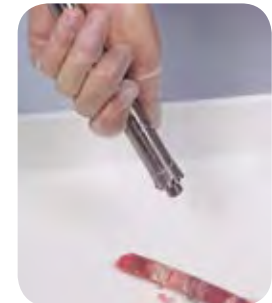

- ▶ Stainless steel V4A (1.4404/1.4571)
- ▶ Sterilisable
- ▶ 20 cm boring depth

| Ice borer     |               |                   |         |              |  |  |  |
|---------------|---------------|-------------------|---------|--------------|--|--|--|
| Inner dia. mm | Outer dia. mm | Drilling depth mm | Price € | Item no.     |  |  |  |
| 16            | 21            | 200               | 254.40  | 5323-0200 N4 |  |  |  |
| 50            | 54            | 200               | 432.15  | 5323-2010 N4 |  |  |  |

## Soil sampler GeoSampler | soil sampling



Soil sampler for light soils, meadows and lawns. The foot bar of model 5350-5006 makes work much easier.

- ▶ Stainless steel

### Soil sampler GeoSampler

| Model            | Total length cm | Flute length mm | Outer dia. mm | Inner flute dia. mm | Weight g | Price € | Item no.     |
|------------------|-----------------|-----------------|---------------|---------------------|----------|---------|--------------|
| without foot bar | 56              | 300             | 17            | 11                  | 550      | 75.35   | 5350-5003 N2 |
| with foot bar    | 81              | 300             | 20            | 14                  | 1500     | 96.35   | 5350-5006 N2 |

## Soil sampler Puerckhauer | soil sampling



Very robust Puerckhauer-sampler for heavy and stony soils. Model 5350-5018 has a conically-tapered 60 cm tip which makes it much easier to extract the driven-in sampler. Ideal for N-min sampling 0 – 90 cm.

- ▶ Depth graduation 10 cm divisions
- ▶ Attachable handle, with non-slip plastic grips
- ▶ Reinforced impact head
- ▶ Stainless steel

### Soil sampler Puerckhauer

| Total length cm | Flute length mm | Outer dia. top mm | Outer dia. bottom mm | Inner flute dia. mm | Weight g | Price € | Item no.     |
|-----------------|-----------------|-------------------|----------------------|---------------------|----------|---------|--------------|
| 81              | 600             | 20                | 20                   | 13                  | 2400     | 245.40  | 5350-5012 N2 |
| 117,5           | 1000            | 28                | 25                   | 18                  | 3800     | 543.25  | 5350-5018 N2 |

## Mole with handle and bar

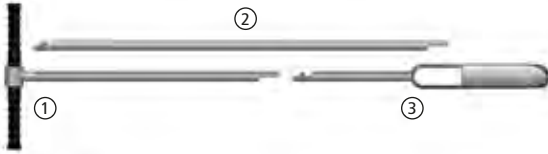

Very robust model with specially hardened forged drill bits. For determining soil properties, moisture and structure. The shape of the Mole's drill bits ensures minimum friction when drilling and removing the Mole from the ground. This reduces physical effort to a minimum.

The Mole has different components. Handle with 75 cm rod, extension rod 100 cm if necessary and one of seven available drill bits, each of which is designed for a particular soil type. The components can be combined without any problems. Extension rods can extend the working depth of the Mole down to 5 m.

Please order drill bits separately!

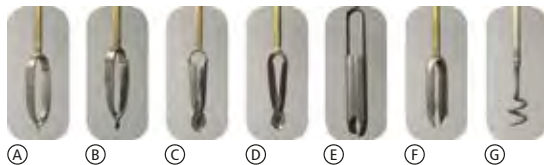

| ① Mole with handle and bar         |           |         |              |
|------------------------------------|-----------|---------|--------------|
| Model                              | Length cm | Price € | Item no.     |
| handle with rod, without drill bit | 75        | 161.40  | 5350-1005 N4 |
| 📦 Accessories                      |           |         |              |
| Description                        |           | Price € | Item no.     |
| ② Extension for mole               |           | 75.35   | 5350-1010 N4 |
| Transport case LxWxH 123x25x11 cm  |           | 95.25   | 3600-2120 N4 |

## Drill bits for mole

There are various drill bits for Mole, which are each designed for very specific soil properties:

### Ⓐ Clay and damp soil

With narrow side panels for minimum soil friction/resistance. As wet soils are usually very cohesive, the soil still adheres to the bit very well.

### Ⓑ Sand

With broad side panels and therefore a large retention capacity for the sand.

### Ⓒ Coarse sand

With extra broad side panels enclosing even more of the bit so that even coarse sandy soils and very dry soils are retained.

### Ⓓ Combination

Retains both strongly cohesive and less cohesive soils.

### Ⓔ Riverside

Very suitable for drilling in hard, encrusted soils and soils mixed with fine gravel. The drill cutters project from the drill itself, so that friction is greatly reduced.

### Ⓕ Gravel drill

With slightly rounded, oblique scoops which pull themselves downward in the gravel. Any stones present are clamped between the drill sides. Finer soil material (coarse sand with fine gravel) is retained in the drill bit.

### Ⓖ Stone catcher

The stone catcher is used to collect and remove stones that prevent proper sampling with one of the other drill bits.

## ③ Drill bits for mole

| Model                | Price € | Quantity scale from | Scale price € | Item no.     |
|----------------------|---------|---------------------|---------------|--------------|
| Ⓐ clay and wet soils | 106.25  | 5                   | 100.10        | 5350-1015 N4 |
| Ⓑ sand               | 127.20  | 5                   | 121.25        | 5350-1020 N4 |
| Ⓒ coarse sand        | 185.00  | 5                   | 171.80        | 5350-1025 N4 |
| Ⓓ combination        | 121.05  | 5                   | 113.75        | 5350-1030 N4 |
| Ⓔ riverside          | 185.00  | 5                   | 169.40        | 5350-1035 N4 |
| Ⓕ gravel drill       | 155.85  | 5                   | 149.40        | 5350-1040 N4 |
| Ⓖ stone catcher      | 139.60  | 5                   | 133.50        | 5350-1045 N4 |

## MiniTherm



This immersion/insertion thermometer is suitable for measuring temperatures in gases, soft or powdered substances and liquids.

New: The mini thermometer in watertight design can simply be rinsed under flowing water or even cleaned in a dishwasher.

- ▶ Easy and quick battery replacement, battery included
- ▶ Sensor directly in the measuring tip
- ▶ Handy
- ▶ Many uses

### MiniTherm



| Model      | Measuring range °C | Length mm | Dia. mm | IP Code | Price € | Item no.     |
|------------|--------------------|-----------|---------|---------|---------|--------------|
| standard   | -50 to +150        | 133       | 4       | 41      | 37.45   | 5384-0011 N2 |
| watertight | -20 to +230        | 120       | 4       | 67      | 55.25   | 5384-0012 N2 |

## SnowPack® dry ice machine



SnowPack® enables you to obtain a -79 °C dry ice tablet weighing 50 or 250 g within a few moments, without complicated technology and without electricity! You can therefore obtain low-cost cooling to very low temperatures at any time you like.

SnowPack® is often used in hospitals, universities, schools, institutes, laboratories, in the chemical industry and in materials testing facilities.

Examples of use: Lowering the temperature in cooling baths or cold traps, pre-cooling tissue samples, ensuring safe transport or embedding biological substances, freezing blood and tissue samples, studies in chemistry, physics and materials technology, etc.

Dry ice is easy to handle, odourless and flavourless. The SnowPack® dry ice machine can be installed on any commercial CO<sub>2</sub>-bottle with a standpipe (without pressure regulator) (thread W 21.80 x 1/14" according to DIN 477-1 No. 6). These often exist in many production facilities and laboratories anyway. If this is not the case, a bottle can be rented for a small price from a local specialist gas distributor. For more info see page 226.

### SnowPack® dry ice machine

| Model         | Tablet dia. x H mm | Weight g | Gas escape time ca. min | Tablets per 22 kg bottle | Price € | Item no.     |
|---------------|--------------------|----------|-------------------------|--------------------------|---------|--------------|
| SnowPack® 50  | 50 x 30            | 50       | 0,5                     | approx. 90               | 194.85  | 9805-0030 N4 |
| SnowPack® 250 | 80 x 60            | 250      | 1                       | approx. 16               | 239.45  | 9805-0200 N4 |



# Sample containers | for neat, safe and reliable transport from sampling to analysis



## Sample boxes, aseptic

Sample box with tightly closing sealing cover. The lid can be opened with one hand and its hinge angle is 90°. Liquid/condensate in the lid runs into an absorbing groove integrated in the lid, nothing is lost, nothing can drip. The box is completely tight, has no crevices, is therefore easy to fill and can be emptied without residues. The sample box is produced under aseptic conditions. It is autoclavable and suitable for deep freezing.

- ▶ PP, transparent
- ▶ Aseptic
- ▶ With area for labelling and graduation



## Sample container, round

Sample box with screw lid. Ideal for taking samples and transport. Available in two material qualities: highly transparent PP for powder, pastes, liquids, or PFA for super pure collection of samples. Emptying without residues because there are no crevices.

- ▶ PP or PFA autoclavable
- ▶ Thick sides
- ▶ Sample container PFA not suitable for food



## Sample tubes aseptic, with seal

The sample boxes are manufactured in the cleanroom and sealed in the injection moulding machine at over 100°C, so that the insides of the boxes are virtually sterile. This method makes the boxes absolutely leakproof, as the cap and box adapt ideally to each other during the cooling process. No crevices, therefore easy to fill and can be emptied without residues. With tamper-evident seal which guarantees virtual sterility until the first opening. After opening, it can be sealed again with a practical seal.

- ▶ PP, transparent
- ▶ Aseptic
- ▶ With graduation
- ▶ Sterilisable

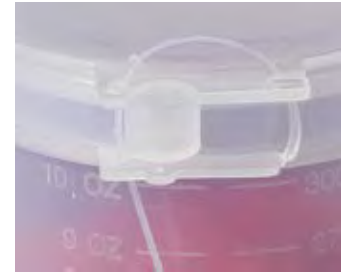

### Sample boxes, aseptic

| Capacity ml | Height mm | Dia. mm | Model                                     | Price € | Quantity scale from | Scale price € | Item no.     |
|-------------|-----------|---------|---|---------|---------------------|---------------|--------------|
| 50          | 78        | 31      | with labeling area and graduation         | 0.32    | 650                 | 0.30          | 6206-0060 N3 |
| 90          | 80        | 43      | with labeling area and graduation at 80ml | 0.37    | 350                 | 0.34          | 6206-0100 N3 |
| 300         | 88        | 75      | graduated                                 | 0.97    | 240                 | 0.90          | 6206-0300 N3 |

### Sample container, round

| Material | Capacity ml | Inner dia. mm | Outer dia. mm | Height with cap mm | Price € | Quantity scale from | Scale price € | Item no.     |
|----------|-------------|---------------|---------------|--------------------|---------|---------------------|---------------|--------------|
| PP       | 60          | 35            | 50            | 93                 | 7.50    | 10                  | 6.55          | 6203-0060 N3 |
| PP       | 180         | 50            | 65            | 119                | 10.80   | 10                  | 9.50          | 6203-0180 N3 |
| PFA      | 90          | 50            | 65            | 65                 | 56.45   | 10                  | 51.45         | 6205-0090 N3 |
| PFA      | 180         | 50            | 65            | 119                | 73.05   | 10                  | 64.80         | 6205-0180 N3 |

### Sample tubes aseptic, with seal

| Capacity ml | Height mm | Dia. mm | Price € | Quantity scale from | Scale price € | Item no.     |
|-------------|-----------|---------|---------|---------------------|---------------|--------------|
| 55          | 84        | 29      | 0.35    | 90                  | 0.33          | 6207-0055 N3 |
| 340         | 119       | 63      | 0.62    | 90                  | 0.55          | 6207-0340 N3 |

## Tubes with screw cap



Shapely packing container with screw cap. Emptying without residues because there are no crevices, cost-effective.

- ▶ PP, white
- ▶ Sterilisable

### Tubes with screw cap

| Capacity ml | Dia. mm | Height mm | Price € | Quantity scale from | Scale price € | Item no.  |    |
|-------------|---------|-----------|---------|---------------------|---------------|-----------|----|
| 12          | 25      | 31        | 0.22    | 100                 | 0.19          | 6214-0012 | N3 |
| 25          | 31      | 40        | 0.32    | 100                 | 0.27          | 6214-0025 | N3 |
| 60          | 41      | 56        | 0.57    | 100                 | 0.46          | 6214-0060 | N3 |
| 90          | 52      | 52        | 0.64    | 100                 | 0.52          | 6214-0090 | N3 |
| 125         | 52      | 67        | 0.73    | 100                 | 0.57          | 6214-0125 | N3 |
| 250         | 68      | 79        | 1.19    | 100                 | 0.93          | 6214-0250 | N3 |
| 625         | 90      | 113       | 1.29    | 70                  | 1.04          | 6214-0600 | N3 |
| 1000        | 102     | 129       | 3.19    | 80                  | 2.48          | 6214-1000 | N3 |

## Sample beaker with cover



Sample beaker with liquid-tight red screw-on cover. The sample beakers are aseptic and suitable for use with food. The beakers can be autoclaved without the cover.

- ▶ PP beaker, LDPE cover
- ▶ Temperature resistance of beaker  $-20^{\circ}\text{C}/+120^{\circ}\text{C}$ , cover  $-80^{\circ}\text{C}/+75^{\circ}\text{C}$
- ▶ Aseptic

### Sample beaker with cover

| Capacity ml | Dia. mm | Height mm | Price € | Quantity scale from | Scale price € | Item no.  |    |
|-------------|---------|-----------|---------|---------------------|---------------|-----------|----|
| 125         | 52      | 74        | 0.91    | 380                 | 0.73          | 7103-0125 | N3 |

## Aluminium bottle | light, unbreakable, seamless

## Sealable wide-necked bottles



The aluminium bottle is particularly suited for storing, transport or sending substances and reference samples which have to be stored completely unaltered. Other properties: can be completely emptied without residues, odour-neutral, impervious to light, rustproof.

Sturdy bottle with sealing eyelets on the screw cap and the bottle. Particularly suited for sending samples. Seals provide increased sample authenticity. Easy to fill due to wide opening. Particularly suitable for viscous media, powder, granules and pastes.

- ▶ Pure aluminium (material AL 99.5)
- ▶ With tamper-evident screw cap made of PP with aluminium inner seal
- ▶ Suitable for food
- ▶ With UN approval (for 60-1200 ml)

- ▶ HDPE
- ▶ Leakproof
- ▶ Easy to fill due to wide-necked opening

| Aluminium bottle |         |                    |             |         |                     |               |           |    |  |
|------------------|---------|--------------------|-------------|---------|---------------------|---------------|-----------|----|--|
| Capacity ml      | Dia. mm | Height with cap mm | UN approval | Price € | Quantity scale from | Scale price € | Item no.  |    |  |
| 38               | 35      | 70                 | no          | 1.42    | 387                 | 1.30          | 0327-0038 | N3 |  |
| 60               | 40      | 88                 | 1B1/X/250   | 1.55    | 304                 | 1.41          | 0327-0060 | N3 |  |
| 120              | 57      | 97                 | 1B1/X/250   | 1.86    | 143                 | 1.68          | 0327-0120 | N3 |  |
| 300              | 57      | 160                | 1B1/X/250   | 2.48    | 149                 | 2.42          | 0327-0300 | N3 |  |
| 600              | 74      | 192                | 1B1/X/250   | 3.60    | 84                  | 3.51          | 0327-0600 | N3 |  |
| 1200             | 88      | 248                | 1B1/X/250   | 4.27    | 130                 | 4.07          | 0327-1200 | N3 |  |

| Sealable wide-necked bottles     |                   |                     |                    |         |                     |               |           |           |  |    |
|----------------------------------|-------------------|---------------------|--------------------|---------|---------------------|---------------|-----------|-----------|--|----|
| Capacity ml                      | Container dia. mm | Neck dia. inside mm | Height with cap mm | Price € | Quantity scale from | Scale price € | Item no.  |           |  |    |
| 250                              | 64                | 26,5                | 118                | 2.35    | 50                  | 2.03          | 0322-0250 | N3        |  |    |
| 500                              | 78                | 40                  | 147                | 2.42    | 50                  | 2.12          | 0322-0500 | N3        |  |    |
| 1000                             | 100               | 50                  | 186                | 4.96    | 50                  | 4.12          | 0322-1000 | N3        |  |    |
| 2000                             | 120               | 50                  | 230                | 5.65    | 50                  | 4.88          | 0322-2000 | N3        |  |    |
| Accessories                      |                   |                     |                    |         |                     |               |           |           |  |    |
| Description                      |                   |                     |                    |         |                     |               | Price €   | Item no.  |  |    |
| SampleSafe seal, red, 100 pieces |                   |                     |                    |         |                     |               | 70.55     | 5399-2902 |  | N2 |

## Table of contents containers



- 156 – 162 Narrow-necked bottles
- 163 – 166 Wide-necked bottles
- 167 – 172 Wash bottles and dropping bottles
- 174 – 175 Aluminium bottles
- 176 – 181 Boxes
- 179 – 181 Sample containers
- 182 – 188 Canisters, wide-mouth containers
- 188 – 189 Storage/stacking containers
- 190 – 193 Tubs, big containers
- 194 – 195 Safety containers
- 196 – 197 Packaging buckets, packaging bags



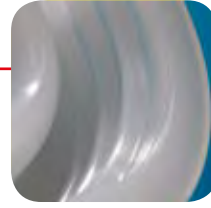

## Containers

Bottles, tubes, jerry cans

# Narrow-necked bottles for universal use | easy to handle and squeeze, reliable outflow



Universal bottles for storing, packing, lab, taking samples, sampling and transport of liquids.

- ▶ With screw cap
- ▶ LDPE, transparent
- ▶ With wash bottle closure  
see Page 170
- ▶ With dropper cap  
see Page 172

**\* Bulk prices**

## Narrow-necked bottles for universal use

| Capacity ml | Container dia. mm | Height with cap mm | Neck dia. inside mm | Thread dia. mm | Price € | Quantity scale from | Scale price € | Item no.     |
|-------------|-------------------|--------------------|---------------------|----------------|---------|---------------------|---------------|--------------|
| 10          | 26                | 47                 | 9                   | 14             | 0.50    | 100                 | 0.38          | 0302-0010 N3 |
| 20          | 32                | 58                 | 9                   | 14             | 0.55    | 100                 | 0.43          | 0302-0020 N3 |
| 30          | 35                | 67                 | 9                   | 14             | 0.65    | 100                 | 0.52          | 0302-0030 N3 |
| 50          | 40                | 86                 | 13                  | 18             | 0.85    | 100                 | 0.62          | 0302-0050 N3 |
| 100         | 45                | 106                | 13                  | 18             | 0.93    | 100                 | 0.64          | 0302-0100 N3 |
| 200         | 58                | 134                | 13                  | 18             | 1.59    | 25                  | 1.28          | 0302-0200 N3 |
| 250         | 60                | 140                | 18                  | 25             | 1.62    | 50                  | 1.30          | 0302-0250 N3 |
| 500         | 75                | 173                | 18                  | 25             | 2.42    | 50                  | 1.86          | 0302-0500 N3 |
| 1000        | 95                | 213                | 21                  | 28             | 3.66    | 50                  | 2.69          | 0302-1000 N3 |
| 2000        | 120               | 263                | 21                  | 28             | 6.50    | 50                  | 4.88          | 0302-2000 N3 |
| 3000        | 139               | 306                | 24                  | 32             | 11.10   | 20                  | 8.30          | 0302-3000 N3 |
| 5000        | 163               | 360                | 31                  | 40             | 15.35   | 10                  | 13.40         | 0302-5000 N3 |



## Round bottles with snap closure



Handy round bottles with snap-action hinged lid, especially suited for cosmetic liquids, emulsions, creams and oils. Sampling possible per portion.

- ▶ HDPE transparent
- ▶ Snap closure with hole  $\varnothing$  3 mm
- ▶ Cost-effective and shapely

**Bulk prices**

### Round bottles with snap closure

| Capacity ml | Height with cap mm | Thread dia. mm | Price € | Quantity scale from | Scale price € | Item no.  |    |  |  |  |
|-------------|--------------------|----------------|---------|---------------------|---------------|-----------|----|--|--|--|
| 100         | 115                | 22             | 0.97    | 50                  | 0.89          | 0308-0100 | N3 |  |  |  |
| 250         | 143                | 22             | 1.23    | 50                  | 1.10          | 0308-0250 | N3 |  |  |  |
| 500         | 182                | 25             | 1.57    | 50                  | 1.50          | 0308-0500 | N3 |  |  |  |
| 1000        | 221                | 25             | 2.31    | 72                  | 2.10          | 0308-1000 | N3 |  |  |  |

## Tall-form bottles



Universal bottle for storing, packing, lab, sampling.

- ▶ LDPE, transparent
- ▶ Leakproof
- ▶ With screw cap
- ▶ Matching dropper cap is available as accessory

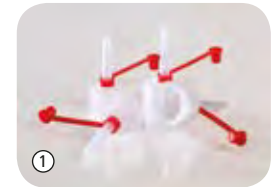

### Tall-form bottles

| Capacity ml | Dia. mm | Height mm | Neck dia. inside mm | Thread dia. mm | Price € | Quantity scale from | Scale price € | Item no.  |    |  |  |  |
|-------------|---------|-----------|---------------------|----------------|---------|---------------------|---------------|-----------|----|--|--|--|
| 100         | 45      | 98        | 13                  | 18             | 0.93    | 100                 | 0.71          | 0314-0100 | N3 |  |  |  |
| 250         | 61      | 128       | 18                  | 25             | 1.47    | 50                  | 1.10          | 0314-0250 | N3 |  |  |  |
| 500         | 77      | 162       | 18                  | 25             | 2.29    | 50                  | 1.72          | 0314-0500 | N3 |  |  |  |
| 1000        | 95      | 198       | 21,6                | 28             | 3.42    | 50                  | 2.47          | 0314-1000 | N3 |  |  |  |

### Accessories

| Description                              | Price € | Item no.     |
|--|---------|--------------|
| ① Dropper cap fits for thread dia. 18 mm | 0.31    | 0300-3018 N3 |
| ① Dropper cap fits for thread dia. 25 mm | 0.39    | 0300-3025 N3 |
| ① Dropper cap fits for thread dia. 28 mm | 0.42    | 0300-3028 N3 |

# The purity of disposable products and ecological sustainability combined perfectly!



With our new LaboPlast® Bio and SteriPlast® Bio product lines, we offer you products that features all the properties for high-quality sampling. The improved specifications in this area can in part only be realised with disposable products. However to take into account environmental awareness and to safeguard ecologically sustainable trade, we now also offer these disposable products made of bio-plastic.



LaboPlast® bio-products are only manufactured from renewable raw materials. SteriPlast® bio-products are also sterilised by gamma rays. To create a completely sustainable product, the individual packaging is also made of bio-PE. This is 100 % recyclable and is manufactured without fossil raw materials. This also involves a CO<sub>2</sub> saving as well as a reduction of the greenhouse effect.



Sugarcane  
100% renewable raw material



100% recyclable



**I'm green**

**Green PE**

Reduces CO<sub>2</sub> (2.1 t/t PE)  
Reduces the greenhouse effect

**b** LaboPlast  
Bio

**b** SteriPlast  
Bio

## Optimum product properties

- ▶ A perfect match for sampling purposes
- ▶ With EU foodstuffs and FDA approval
- ▶ Mainly manufactured, assembled and packed in Bürkle's own clean room
- ▶ SteriPlast® Bio sterilised by gamma rays is also available

## Environmentally friendly and sustainable

- ▶ Product and packaging made of bio-plastic
- ▶ Made of sustainable raw materials, dispensing with fossil materials
- ▶ CO<sub>2</sub> saving and thus reduction of the greenhouse effect
- ▶ 100 % recyclable
- ▶ Sugarcane, 100 % renewable raw material – reduces CO<sub>2</sub> (2.1 t/t PE) – reduces the greenhouse effect



## Narrow-necked bio-bottles PE

The narrow-necked bio-bottles are manufactured from green PE biopolymer. This material has the same outstanding properties as conventional PE and can be recycled. However it is manufactured from renewable raw materials instead of fossils. Green PE therefore helps to reduce CO<sub>2</sub> emissions and protect the environment.

- ▶ With screw connection
- ▶ Manufactured from renewable raw materials
- ▶ Green LDPE



### Narrow-necked bio-bottles PE

| Capacity ml | Container dia. mm | Height with cap mm | Neck dia. inside mm | Thread dia. mm | Price € | Quantity scale from | Scale price € | Item no.     |
|-------------|-------------------|--------------------|---------------------|----------------|---------|---------------------|---------------|--------------|
| 10          | 26                | 47                 | 9                   | 14             | 0.63    | 100                 | 0.50          | 0303-0010 N3 |
| 20          | 32                | 58                 | 9                   | 14             | 0.68    | 100                 | 0.55          | 0303-0020 N3 |
| 50          | 40                | 86                 | 13                  | 18             | 1.01    | 100                 | 0.78          | 0303-0050 N3 |
| 100         | 45                | 106                | 13                  | 18             | 1.10    | 100                 | 0.81          | 0303-0100 N3 |
| 250         | 60                | 140                | 18                  | 25             | 1.83    | 100                 | 1.51          | 0303-0250 N3 |
| 500         | 75                | 173                | 18                  | 25             | 2.65    | 100                 | 2.00          | 0303-0500 N3 |
| 1000        | 95                | 213                | 21                  | 28             | 4.00    | 100                 | 2.79          | 0303-1000 N3 |



## Laboratory bottle PET sterile



Sterile laboratory bottle for use in laboratories and chemical handling areas. Good product presentation due to crystal-clear PET. Space-saving and absolutely leakproof. Ideal for storing and packing liquids.

- ▶ Sterile SAL 10<sup>-3</sup> (according to ISO 11137)
- ▶ PET crystal-clear
- ▶ With tamper-proof closure
- ▶ With moulded-in raised graduation

Laboratory bottle PET sterile

| Capacity ml | L x W mm | Height with cap mm | Neck dia. inside mm | Price € | Quantity scale from | Scale price € | Item no.  |    |  |  |  |
|-------------|----------|--------------------|---------------------|---------|---------------------|---------------|-----------|----|--|--|--|
| 125         | 53 x 53  | 105                | 32                  | 1.36    | 336                 | 1.22          | 0370-0125 | N3 |  |  |  |
| 250         | 64 x 64  | 132                | 32                  | 1.51    | 144                 | 1.37          | 0370-0250 | N3 |  |  |  |
| 500         | 76 x 76  | 173                | 32                  | 2.30    | 120                 | 2.08          | 0370-0500 | N3 |  |  |  |
| 1000        | 96 x 96  | 212                | 32                  | 3.11    | 48                  | 2.86          | 0370-1000 | N3 |  |  |  |

## Laboratory bottles with graduation PC



High-quality laboratory bottle made of polycarbonate for universal use. Shatterproof at room temperature. Easily operated screw thread, safe pouring, with moulded-in raised contents graduation.

- ▶ Polycarbonate crystal-clear, autoclavable
- ▶ With screw cap PP
- ▶ Guaranteed leakproof
- ▶ With moulded-in raised graduation

Laboratory bottles with graduation PC

| Capacity ml | L x W mm  | Height with cap mm | Neck dia. inside mm | Thread dia. mm | Price € | Quantity scale from | Scale price € | Item no.  |    |  |  |  |
|-------------|-----------|--------------------|---------------------|----------------|---------|---------------------|---------------|-----------|----|--|--|--|
| 125         | 55 x 55   | 109                | 28                  | 37             | 7.20    | 6                   | 6.35          | 0316-0125 | N2 |  |  |  |
| 250         | 61 x 61   | 145                | 28                  | 37             | 8.95    | 6                   | 8.25          | 0316-0250 | N2 |  |  |  |
| 1000        | 95 x 95   | 218                | 28                  | 37             | 21.05   | 4                   | 19.15         | 0316-1000 | N2 |  |  |  |
| 2000        | 116 x 116 | 275                | 39                  | 53             | 48.95   | 6                   | 44.55         | 0316-2000 | N2 |  |  |  |

## Narrow-necked square bottle



Cost-effective square bottle for packing and storing of liquids, powders and granules.

- ▶ HDPE, transparent, shatterproof
- ▶ Special labelling area for labels or manual lettering
- ▶ Leakproof

### Narrow-necked square bottle

| Capacity ml | L x W mm | Height with cap mm | Neck dia. inside mm | Thread dia. mm | Price € | Quantity scale from | Scale price € | Item no.  |    |  |  |  |
|-------------|----------|--------------------|---------------------|----------------|---------|---------------------|---------------|-----------|----|--|--|--|
| 20          | 27 x 27  | 51                 | 13                  | 18             | 0.46    | 100                 | 0.43          | 0331-0020 | N3 |  |  |  |
| 50          | 33 x 34  | 77                 | 13                  | 18             | 0.57    | 100                 | 0.55          | 0331-0050 | N3 |  |  |  |
| 100         | 43 x 43  | 78                 | 17,5                | 25             | 0.71    | 100                 | 0.64          | 0331-0100 | N3 |  |  |  |

## Narrow-necked square bottle, screw cap



Cost-effective square bottle for packing and storing of liquids.

- ▶ HDPE, transparent, shatterproof
- ▶ Special labelling area for labels or manual lettering
- ▶ Suitable as a disposable bottle
- ▶ Leakproof
- ▶ With screw cap



### Narrow-necked square bottle with screw cap

| Capacity ml | L x W mm | Height with cap mm | Thread dia. mm | Neck dia. inside mm | Price € | Quantity scale from | Scale price € | Item no.  |    |  |  |  |
|-------------|----------|--------------------|----------------|---------------------|---------|---------------------|---------------|-----------|----|--|--|--|
| 100         | 41 x 33  | 113                | 18             | 13                  | 0.62    | 100                 | 0.57          | 0332-0100 | N3 |  |  |  |
| 250         | 51 x 43  | 160                | 25             | 17,5                | 0.90    | 50                  | 0.84          | 0332-0250 | N3 |  |  |  |
| 500         | 68 x 53  | 182                | 25             | 17,5                | 1.09    | 50                  | 1.01          | 0332-0500 | N3 |  |  |  |
| 1000        | 89 x 66  | 230                | 25             | 17,5                | 1.73    | 50                  | 1.57          | 0332-1000 | N3 |  |  |  |

### Accessories

| Description                            | Price € | Item no.     |
|--|---------|--------------|
| Dropper cap fits for thread dia. 18 mm | 0.31    | 0300-3018 N3 |
| Dropper cap fits for thread dia. 25 mm | 0.39    | 0300-3025 N3 |

# Narrow-neck reagent bottle



Universal bottles for storing, packing, taking samples, sampling and transport of liquids.

- ▶ HDPE, transparent
- ▶ PP tamper-evident screw cap, blue

**Bulk prices**

## Narrow-neck reagent bottle

| Capacity ml | L x W mm  | Height capless mm | Thread dia. mm | Neck dia. inside mm | Price € | Quantity scale from | Scale price € | Item no.     |
|-------------|-----------|-------------------|----------------|---------------------|---------|---------------------|---------------|--------------|
| 100         | 45 x 45   | 108               | 32             | 17                  | 1.61    | 100                 | 1.49          | 0340-0100 N3 |
| 250         | 60 x 60   | 136               | 32             | 17                  | 1.96    | 50                  | 1.90          | 0340-0250 N3 |
| 500         | 74 x 74   | 170               | 32             | 17                  | 2.31    | 50                  | 2.21          | 0340-0500 N3 |
| 1000        | 85 x 85   | 221               | 32             | 17                  | 2.99    | 72                  | 2.84          | 0340-1000 N3 |
| 2500        | 122 x 122 | 272               | 45             | 28                  | 7.30    | 27                  | 6.55          | 0340-2500 N3 |



## Wide-neck reagent bottle



The reagent bottle is particularly suited for storing, packing, taking samples, sampling and transport of granules and paste-like media.

- ▶ HDPE, transparent
- ▶ PP tamper-evident screw cap, blue
- ▶ UN approval for bulk goods (see page 265)

**Bulk prices**

### Wide-neck reagent bottle

| Capacity ml | L x W mm  | Height capless mm | Thread dia. mm | Neck dia. inside mm | UN approval | Price € | Quantity scale from | Scale price € | Item no.     |
|-------------|-----------|-------------------|----------------|---------------------|-------------|---------|---------------------|---------------|--------------|
| 50          | 36 x 36   | 89                | 28             | 21                  | no          | 1.59    | 700                 | 1.46          | 0342-0050 N3 |
| 100         | 45 x 45   | 101               | 32             | 24                  | UN3H1/X0.3  | 1.44    | 582                 | 1.31          | 0342-0100 N3 |
| 250         | 59 x 59   | 130               | 45             | 35                  | UN3H1/X0.8  | 2.09    | 273                 | 1.88          | 0342-0250 N3 |
| 500         | 75 x 75   | 162               | 54             | 43                  | UN3H1/X1.5  | 2.42    | 124                 | 2.23          | 0342-0500 N3 |
| 750         | 83 x 83   | 188               | 54             | 43                  | UN3H1/X2.5  | 2.44    | 90                  | 2.30          | 0342-0750 N3 |
| 1000        | 85 x 85   | 214               | 54             | 43                  | UN3H1/X2.5  | 2.49    | 81                  | 2.41          | 0342-1000 N3 |
| 1500        | 108 x 108 | 209               | 80             | 69                  | UN3H1/X4    | 3.96    | 42                  | 3.64          | 0342-1500 N3 |
| 2500        | 122 x 122 | 260               | 80             | 69                  | UN3H1/X5    | 5.25    | 27                  | 4.63          | 0342-2500 N3 |
| 4000        | 142 x 142 | 294               | 80             | 69                  | UN3H1/X5.5  | 6.55    | 15                  | 5.95          | 0342-4000 N3 |

# Wide-necked bottle | easy to fill and clean, compact form, unbreakable



Sturdy bottle with wide-necked opening and screw cap. Particularly suitable for viscous media, powder, granules and pastes. Leakproof.

- ▶ LDPE or PP
- ▶ LDPE coloured brown for light-sensitive liquids

Individual customer-specific printing possible - please ask us!

## Wide-necked bottle

| Material | Capacity ml | Colour      | Dia. mm | Height mm | Neck dia. inside mm | Thread dia. mm | Price € | Quantity scale from | Scale price € | Item no.     |
|----------|-------------|-------------|---------|-----------|---------------------|----------------|---------|---------------------|---------------|--------------|
| LDPE     | 50          | transparent | 40      | 80        | 24                  | 32             | 0.98    | 100                 | 0.79          | 0318-0050 N3 |
| LDPE     | 100         | transparent | 48      | 95        | 24                  | 32             | 1.29    | 100                 | 0.96          | 0318-0100 N3 |
| LDPE     | 200         | transparent | 59      | 114       | 30                  | 40             | 1.75    | 384                 | 1.44          | 0318-0200 N3 |
| LDPE     | 250         | transparent | 64      | 127       | 31                  | 40             | 1.67    | 50                  | 1.29          | 0318-0250 N3 |
| LDPE     | 500         | transparent | 77      | 158       | 39                  | 50             | 2.72    | 50                  | 2.07          | 0318-0500 N3 |
| LDPE     | 750         | transparent | 88      | 176       | 39                  | 50             | 4.03    | 98                  | 3.20          | 0318-0750 N3 |
| LDPE     | 1000        | transparent | 94      | 207       | 50                  | 65             | 4.52    | 50                  | 3.51          | 0318-1000 N3 |
| LDPE     | 1500        | transparent | 108     | 232       | 50                  | 65             | 6.50    | 46                  | 5.25          | 0318-1500 N3 |
| LDPE     | 2000        | transparent | 120     | 252       | 50                  | 65             | 7.05    | 50                  | 5.30          | 0318-2000 N3 |
| PP       | 100         | transparent | 48      | 95        | 24                  | 32             | 1.36    | 100                 | 1.02          | 0319-0100 N3 |
| PP       | 250         | transparent | 64      | 127       | 31                  | 40             | 1.87    | 50                  | 1.39          | 0319-0250 N3 |
| PP       | 500         | transparent | 77      | 158       | 39                  | 50             | 3.07    | 100                 | 2.31          | 0319-0500 N3 |
| PP       | 1000        | transparent | 94      | 207       | 50                  | 65             | 5.10    | 50                  | 3.87          | 0319-1000 N3 |
| LDPE     | 250         | brown       | 64      | 127       | 31                  | 40             | 2.15    | 50                  | 1.62          | 0320-0250 N3 |
| LDPE     | 500         | brown       | 77      | 158       | 39                  | 50             | 3.66    | 50                  | 2.69          | 0320-0500 N3 |
| LDPE     | 1000        | brown       | 94      | 207       | 50                  | 65             | 6.40    | 50                  | 5.10          | 0320-1000 N3 |

## Wide-necked square bottle



Cost-effective square bottle for packing and storing of liquids, powders and granules.

- ▶ HDPE, transparent, shatterproof
- ▶ Special labelling area for labels or manual lettering
- ▶ Leakproof

### Wide-necked square bottle

| Capacity ml | L x W mm | Height with cap mm | Neck dia. inside mm | Thread dia. mm | Price € | Quantity scale from | Scale price € | Item no.  |    |  |
|-------------|----------|--------------------|---------------------|----------------|---------|---------------------|---------------|-----------|----|--|
| 250         | 59 x 59  | 110,5              | 30                  | 50             | 2.34    | 100                 | 1.92          | 0338-0250 | N3 |  |
| 500         | 68 x 68  | 146                | 30                  | 50             | 2.86    | 100                 | 2.39          | 0338-0500 | N3 |  |
| 1000        | 90 x 90  | 170                | 50                  | 65             | 2.79    | 50                  | 2.58          | 0338-1000 | N3 |  |

## Multi-Bottles with graduation



Bottle for universal use. The medium-sized bottle opening ensures good filling and safe pouring.

- ▶ Bottle HDPE, lid PP
- ▶ Embossed contents scale
- ▶ Absolutely leakproof
- ▶ With screw cap

**Bulk prices**

### Multi-Bottles with graduation

| Capacity ml | Container dia. mm | Height capless mm | Neck dia. inside mm | Division ml | Thread dia. mm | Price € | Quantity scale from | Scale price € | Item no.  |    |  |
|-------------|-------------------|-------------------|---------------------|-------------|----------------|---------|---------------------|---------------|-----------|----|--|
| 100         | 46                | 99,5              | 19                  | 25          | 25             | 1.08    | 20                  | 1.00          | 0301-0100 | N3 |  |
| 250         | 61                | 129,5             | 24                  | 50          | 28             | 1.53    | 10                  | 1.41          | 0301-0250 | N3 |  |
| 500         | 76                | 161               | 30,8                | 50          | 40             | 2.44    | 10                  | 2.26          | 0301-0500 | N3 |  |
| 1000        | 97                | 203               | 39,2                | 100         | 50             | 4.01    | 4                   | 3.69          | 0301-1000 | N3 |  |

## Bottle with child safety lock, narrow neck



Narrow-neck bottles with child-safe, press and turn safety closure. The cover also has a tamper-proof ring which makes it evident when the bottle has been opened for the first time.

- ▶ Ideal for storing hazardous substances
- ▶ HDPE, transparent
- ▶ PP child-safe, screw-on tamper-proof closure

### Bottle with child safety lock, narrow neck

| Capacity ml | L x W mm | Height capless mm | Price € | Quantity scale from | Scale price € | Item no.     |
|-------------|----------|-------------------|---------|---------------------|---------------|--------------|
| 100         | 45 x 45  | 108               | 2.19    | 100                 | 2.07          | 0341-0100 N3 |
| 250         | 60 x 60  | 136               | 2.47    | 100                 | 2.34          | 0341-0250 N3 |
| 500         | 74 x 74  | 170               | 2.79    | 50                  | 2.64          | 0341-0500 N3 |
| 1000        | 85 x 85  | 221               | 3.42    | 72                  | 3.00          | 0341-1000 N3 |

## Sealable wide-necked bottles



Sturdy bottle with sealing eyelets on the screw cap and the bottle. Particularly suited for sending samples. Seals provide increased sample authenticity. Easy to fill due to wide opening. Particularly suitable for viscous media, powder, granules and pastes.

- ▶ HDPE
- ▶ Leakproof
- ▶ Easy to fill due to wide-necked opening

### Sealable wide-necked bottles

| Capacity ml | Container dia. mm | Neck dia. inside mm | Height with cap mm | Price € | Quantity scale from | Scale price € | Item no.     |
|-------------|-------------------|---------------------|--------------------|---------|---------------------|---------------|--------------|
| 250         | 64                | 26,5                | 118                | 2.35    | 50                  | 2.03          | 0322-0250 N3 |
| 500         | 78                | 40                  | 147                | 2.42    | 50                  | 2.12          | 0322-0500 N3 |
| 1000        | 100               | 50                  | 186                | 4.96    | 50                  | 4.12          | 0322-1000 N3 |
| 2000        | 120               | 50                  | 230                | 5.65    | 50                  | 4.88          | 0322-2000 N3 |

### Accessories

| Description                      | Price € | Item no.     |
|----------------------------------|---------|--------------|
| SampleSafe seal, red, 100 pieces | 70.55   | 5399-2902 N2 |



## Spray bottle with pump vaporizer



### LaboPlast

Spray bottles with pump vapouriser and safety cap for the pump. Liquids can be finely vapourised at the push of a button in an environmentally compatible way. The transparent bottles make identification of contents easy. The protective cover prevents unintentional pressing of the pump and acts as a dust cover.

- Bottle made of HDPE, spray pump made of PP and stainless steel

### Spray bottle with pump vaporizer

| Capacity ml | Dia. mm | Height with cap mm | Price € | Quantity scale from | Scale price € | Item no.     |
|-------------|---------|--------------------|---------|---------------------|---------------|--------------|
| 20          | 28      | 85                 | 1.97    | 100                 | 1.75          | 0309-3002 N3 |
| 50          | 35      | 110                | 1.88    | 100                 | 1.63          | 0309-3005 N3 |
| 100         | 37      | 161                | 1.32    | 100                 | 1.25          | 0309-3100 N3 |
| 250         | 50      | 222                | 1.56    | 100                 | 1.45          | 0309-3025 N3 |

# Spray bottle



Pressureless spray bottle made of LDPE with long-life hand pump. The functioning of each individual sprayer is tested during manufacture.

Areas of application: Industry, laboratories, production, leisure, household. Suitable for agricultural pesticides and detergents.

- ▶ Media-contacting parts PP, PE and stainless steel
- ▶ Nozzle 0.6 mm diameter, nozzle steplessly adjustable
- ▶ Spray volume per stroke: 1.2 ml ± 0.1



## Spray bottle

| Capacity ml | Height with cap mm | Neck dia. inside mm | Price € | Quantity scale from | Scale price € | Item no.     |
|-------------|--------------------|---------------------|---------|---------------------|---------------|--------------|
| 250         | 220                | 18                  | 4.77    | 180                 | 4.27          | 0309-1025 N4 |
| 500         | 240                | 18                  | 5.40    | 80                  | 4.83          | 0309-1050 N4 |
| 1000        | 295                | 17,5                | 5.55    | 50                  | 5.10          | 0309-1100 N4 |

## Spray bottle Turn 'n' Spray | Spray bottle with overhead valve



- ▶ Uninterrupted spraying, even over your head
- ▶ Parts in contact with media made of PP, PE, silicon and stainless steel
- ▶ Nozzle diameter 0.6 mm, nozzle is continuously adjustable
- ▶ Amount sprayed per stroke: 1.2 ml ± 0.1

Spraying over your head is not possible with standard spray bottles. As soon as the suction tube is no longer immersed in liquid, you can't spray any more. No so with our overhead spray bottle Turn'n'Spray. It features a special technology that allows you to spray from any position. That means you can spray practically and conveniently from any direction and reach hard-to-access places easily and without straining.

The high-quality, refillable quality spray bottle can be used again and again.

### Spray bottle Turn 'n' Spray

| Capacity ml | Height with cap mm | Neck dia. inside mm | Price € | Quantity scale from | Scale price € | Item no.     |
|-------------|--------------------|---------------------|---------|---------------------|---------------|--------------|
| 250         | 220                | 18                  | 7.05    | 180                 | 6.00          | 0309-0002 N4 |
| 500         | 240                | 18                  | 7.70    | 80                  | 6.70          | 0309-0005 N4 |
| 1000        | 295                | 17,5                | 8.10    | 50                  | 7.15          | 0309-0010 N4 |

## Pressure sprayer



Pressure sprayer, robust industrial quality for disinfection, cleaning, plant protection, thin layer chromatography, technical and sanitary use. The hand pump is used to produce a pressure of up to 4 bar in the container. Spraying can then take place by pressing a button.

- ▶ Media-contacting parts PP, PE, glass-fibre-reinforced PA, V2A, FKM
- ▶ Bottle made of HDPE
- ▶ Nozzle diameter 0.6 mm
- ▶ Adjustable spray jet
- ▶ Graduation up to 1500 ml
- ▶ Temperature max. 30 °C
- ▶ Spraying lance extension 30 cm available as accessory

### Pressure sprayer

| Capacity ml | Container dia. mm | Height with cap mm | Neck dia. inside mm | Price € | Quantity scale from | Scale price € | Item no.     |
|-------------|-------------------|--------------------|---------------------|---------|---------------------|---------------|--------------|
| 1500        | 142               | 315                | 45                  | 32.50   | 10                  | 29.10         | 0309-0100 N4 |

### Accessories

| Description  | Price € | Item no.     |
|--|---------|--------------|
| Spraying lance extension for pressure sprayer, 30 cm | 20.75   | 0309-0101 N4 |

## Wash bottle



The swan-neck jet produces a fine, straight spray with no lateral spatter. Dangerous lateral spatter does not occur.

- ▶ LDPE
- ▶ Transparent
- ▶ Immersion tube can be pulled up



### Wash bottle

| Capacity ml | Dia. mm | Height mm | Price € | Quantity scale from | Scale price € | Item no.     |
|-------------|---------|-----------|---------|---------------------|---------------|--------------|
| 100         | 45      | 200       | 1.47    | 100                 | 1.35          | 0310-0010 N3 |
| 250         | 61      | 225       | 1.99    | 100                 | 1.85          | 0310-0025 N3 |
| 500         | 75      | 270       | 2.60    | 100                 | 2.37          | 0310-0050 N3 |
| 1000        | 98      | 315       | 4.27    | 50                  | 3.89          | 0310-0100 N3 |

## Wide-necked wash bottle



Wash bottle with medium overprint as well as hazard and safety instructions (health statements/physical statements) based on the GHS system with substance name in German, English, French and Spanish, GHS pictograms and CAS number.

- ▶ Safe filling due to wide-necked opening 39 mm neck diameter
- ▶ LDPE yellow transparent with light protection
- ▶ Contents 500 ml



### Wide-necked wash bottle

| Print                   | Colour      | Price € | Quantity scale from | Scale price € | Item no.  |    |  |
|-------------------------|-------------|---------|---------------------|---------------|-----------|----|--|
| without label - neutral | yellow      | 6.85    | 100                 | 6.30          | 0310-3050 | N3 |  |
| Distilled water         | transparent | 7.70    | 100                 | 6.60          | 0310-3051 | N3 |  |
| Methanol                | green       | 7.70    | 100                 | 6.60          | 0310-3052 | N3 |  |
| Ethanol                 | orange      | 7.70    | 100                 | 6.60          | 0310-3053 | N3 |  |
| Isopropanol             | blue        | 7.70    | 100                 | 6.60          | 0310-3054 | N3 |  |
| Acetone                 | red         | 7.70    | 100                 | 6.60          | 0310-3055 | N3 |  |

## Safety wash bottle

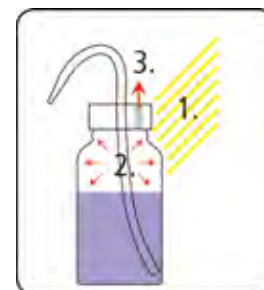

The vapour-permeable membrane reliably prevents leaking of the contents.

If the room temperature increases, or the sun shines into the lab, conventional wash bottles will drip because of the increased inner pressure. The venting valve ensures that the excess pressure can escape and dripping is prevented. With leakproof venting valve, contents cannot leak when bottle has fallen over as with wash bottles with ball valve or venting hole.

- ▶ Safe filling due to wide-necked opening 39 mm neck diameter
- ▶ Permanent print according to GHS with substance name in German, English, French and Spanish, GHS pictograms and CAS number
- ▶ LDPE yellow transparent with light protection
- ▶ Contents 500 ml



### Safety wash bottle

| Print                   | Price € | Quantity scale from | Scale price € | Item no.  |    |  |
|-------------------------|---------|---------------------|---------------|-----------|----|--|
| without label - neutral | 8.95    | 12                  | 8.05          | 0310-2056 | N3 |  |
| Distilled water         | 8.95    | 12                  | 8.05          | 0310-2050 | N3 |  |
| Methanol                | 8.95    | 12                  | 8.05          | 0310-2052 | N3 |  |
| Ethanol                 | 8.95    | 12                  | 8.05          | 0310-2054 | N3 |  |
| Isopropanol             | 8.95    | 12                  | 8.05          | 0310-2055 | N3 |  |
| Acetone                 | 8.95    | 12                  | 8.05          | 0310-2051 | N3 |  |

## Dropping bottles | for controlled dosing drop by drop



Dropping bottles are particularly suitable for liquids which must be dispensed in small amounts, drop by drop or as a fine jet.

- ▶ Cut off dropper tip before first use
- ▶ Can be reclosed using the captive cap provided
- ▶ LDPE
- ▶ Captive cap and dropper cap PE



### Dropping bottles

| Capacity ml | Container dia. mm | Height with cap mm | Neck dia. inside mm | Thread dia. mm | Price € | Quantity scale from | Scale price € | Item no.  |    |  |  |
|-------------|-------------------|--------------------|---------------------|----------------|---------|---------------------|---------------|-----------|----|--|--|
| 10          | 26                | 76                 | 9                   | 14             | 0.51    | 100                 | 0.48          | 0306-0010 | N3 |  |  |
| 20          | 32                | 88                 | 9                   | 14             | 0.56    | 100                 | 0.54          | 0306-0020 | N3 |  |  |
| 30          | 35                | 96                 | 9                   | 14             | 0.68    | 50                  | 0.62          | 0306-0030 | N3 |  |  |
| 50          | 40                | 116                | 13                  | 18             | 0.86    | 50                  | 0.82          | 0306-0050 | N3 |  |  |
| 100         | 45                | 136                | 13                  | 18             | 0.94    | 25                  | 0.90          | 0306-0100 | N3 |  |  |
| 250         | 61                | 170                | 18                  | 25             | 1.64    | 25                  | 1.57          | 0306-0250 | N3 |  |  |
| 500         | 75                | 204                | 18                  | 25             | 2.44    | 20                  | 2.33          | 0306-0500 | N3 |  |  |
| 1000        | 95                | 248                | 21                  | 28             | 3.66    | 10                  | 3.52          | 0306-1000 | N3 |  |  |

## Drop-Boy



Bottle with drop dispenser and separate screw cap.

- ▶ Cut off dropper tip before first use
- ▶ Reclosable
- ▶ Precise drop dosing

### Drop-Boy

| Capacity ml | Dia. mm | Height capless mm | Price € | Quantity scale from | Scale price € | Item no.  |    |
|-------------|---------|-------------------|---------|---------------------|---------------|-----------|----|
| 10          | 24      | 50                | 0.63    | 100                 | 0.57          | 0307-0010 | N3 |
| 25          | 31,3    | 64,5              | 0.80    | 100                 | 0.73          | 0307-0025 | N3 |
| 50          | 40      | 77                | 0.93    | 100                 | 0.84          | 0307-0050 | N3 |

## UN-Bottle



This bottle reduces packaging costs! UN tested and approved. Bottle made of HDPE, leakproof, complete with PR tamper-evident closure with PTFE seal. The bottles are excellent for packaging purposes, sampling, sending samples, storage and shipping via the postal service.

- ▶ Absolutely leakproof
- ▶ With UN approval for liquids (see page 265)
- ▶ Transparent
- ▶ Bell-shaped caps with or without degassing on request

### UN-Bottle

| Capacity ml | Height capless mm | Neck dia. inside mm | UN approval  | Price € | Quantity scale from | Scale price € | Item no.  |    |
|-------------|-------------------|---------------------|--------------|---------|---------------------|---------------|-----------|----|
| 500         | 177               | 29                  | 1H1/X1.9/250 | 3.48    | 120                 | 3.08          | 0304-0500 | N3 |
| 1000        | 212               | 29                  | 3H1/X1.9/250 | 4.39    | 64                  | 4.21          | 0304-1000 | N3 |
| 2500        | 282               | 29                  | 3H1/X1.9/250 | 8.05    | 26                  | 7.40          | 0304-2500 | N3 |

## Bottle carrier



### Bottle carrier

For 6 bottles up to max. 95 mm Ø.

- ▶ PP



### Bottle carrier box

For 8 bottles up to max. 95 mm Ø. With closed floor which can be used as spill trough.

- ▶ HDPE
- ▶ Inside measurements: Length 390 mm, width 110 mm
- ▶ Suitable for food

### Bottle carrier

| No. of bottles | Container dia. mm | Outer dimension of rim L x W x H mm | Price € | Quantity scale from | Scale price € | Item no.     |
|----------------|-------------------|-------------------------------------|---------|---------------------|---------------|--------------|
| 6              | 95                | 310x210x305                         | 11.50   | 10                  | 10.60         | 0361-0006 N3 |

### Bottle carrier box

| No. of bottles | Container dia. mm | Outer dimension of rim L x W x H mm | Price € | Quantity scale from | Scale price € | Item no.     |
|----------------|-------------------|-------------------------------------|---------|---------------------|---------------|--------------|
| 8              | 95                | 420x300x210                         | 24.65   | 10                  | 22.40         | 0361-0008 N3 |

## Aluminium bottle | light, unbreakable, seamless

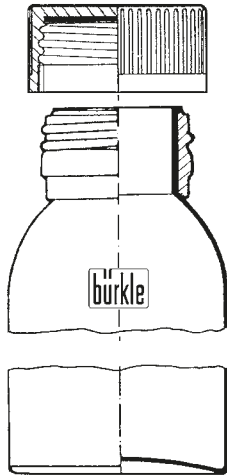

The aluminium bottle is particularly suited for storing, transport or sending substances and reference samples which have to be stored completely unaltered. Other properties: can be completely emptied without residues, odour-neutral, impervious to light, rustproof.

- ▶ Pure aluminium (material AL 99.5)
- ▶ With tamper-evident screw cap made of PP with aluminium inner seal
- ▶ Suitable for food
- ▶ With UN approval (for 60-1200 ml), see page 265



### Aluminium bottle

| Capacity ml | Dia. mm | Height with cap mm | UN approval | Price € | Quantity scale from | Scale price € | Item no.     |
|-------------|---------|--------------------|-------------|---------|---------------------|---------------|--------------|
| 38          | 35      | 70                 | no          | 1.42    | 387                 | 1.30          | 0327-0038 N3 |
| 60          | 40      | 88                 | 1B1/X/250   | 1.55    | 304                 | 1.41          | 0327-0060 N3 |
| 120         | 57      | 97                 | 1B1/X/250   | 1.86    | 143                 | 1.68          | 0327-0120 N3 |
| 300         | 57      | 160                | 1B1/X/250   | 2.48    | 149                 | 2.42          | 0327-0300 N3 |
| 600         | 74      | 192                | 1B1/X/250   | 3.60    | 84                  | 3.51          | 0327-0600 N3 |
| 1200        | 88      | 248                | 1B1/X/250   | 4.27    | 130                 | 4.07          | 0327-1200 N3 |





## Transport bottle aluminium UN | UN-approval for dangerous goods



The UN code is printed onto the bottles in black.



With tamper-evident screw cap made of PP with aluminium inner seal.



Aluminium transport bottles with screw cap close safely and tightly and are approved for packaging type I (X). The UN code is printed onto the bottles in black.

- ▶ Pure aluminium (material AL 99.5)
- ▶ UN approved (see page 265)
- ▶ With eyelets, sealable

### Transport bottle aluminium UN

| Capacity ml | Dia. mm | Height mm | UN approval | Price € | Quantity scale from | Scale price € | Item no.     |
|-------------|---------|-----------|-------------|---------|---------------------|---------------|--------------|
| 125         | 50      | 105       | 1B1/X/250   | 15.35   | 10                  | 13.75         | 0329-0125 N3 |
| 250         | 65      | 140       | 1B1/X/250   | 18.05   | 50                  | 16.45         | 0329-0250 N3 |
| 500         | 80      | 145       | 1B1/X/250   | 22.10   | 30                  | 20.35         | 0329-0500 N3 |
| 1250        | 100     | 205       | 1B1/X/250   | 23.95   | 45                  | 21.80         | 0329-1250 N3 |



## Tubes with screw cap



Shapely packing container with screw cap. Emptying without residues because there are no crevices, cost-effective.

- ▶ PP, white
- ▶ Sterilisable

### Tubes with screw cap

| Capacity ml | Dia. mm | Height mm | Price € | Quantity scale from | Scale price € | Item no.  |    |
|-------------|---------|-----------|---------|---------------------|---------------|-----------|----|
| 12          | 25      | 31        | 0.22    | 100                 | 0.19          | 6214-0012 | N3 |
| 25          | 31      | 40        | 0.32    | 100                 | 0.27          | 6214-0025 | N3 |
| 60          | 41      | 56        | 0.57    | 100                 | 0.46          | 6214-0060 | N3 |
| 90          | 52      | 52        | 0.64    | 100                 | 0.52          | 6214-0090 | N3 |
| 125         | 52      | 67        | 0.73    | 100                 | 0.57          | 6214-0125 | N3 |
| 250         | 68      | 79        | 1.19    | 100                 | 0.93          | 6214-0250 | N3 |
| 625         | 90      | 113       | 1.29    | 70                  | 1.04          | 6214-0600 | N3 |
| 1000        | 102     | 129       | 3.19    | 80                  | 2.48          | 6214-1000 | N3 |

## Wide-necked boxes, round



Wide-necked containers with very good shatter resistance for convenient filling. Particularly suited for storing or shipping powders and granules.

- ▶ HDPE, transparent, shatterproof
- ▶ Screw lid made of PP with seal made of PE

**Bulk prices**

### Wide-necked boxes, round

| Capacity ml | Dia. mm | Neck dia. inside mm | Height capless mm | Price € | Quantity scale from | Scale price € | Item no.  |    |
|-------------|---------|---------------------|-------------------|---------|---------------------|---------------|-----------|----|
| 100         | 48      | 31                  | 77                | 1.32    | 100                 | 1.18          | 6282-0100 | N3 |
| 250         | 65      | 41                  | 98                | 1.92    | 100                 | 1.69          | 6282-0250 | N3 |
| 500         | 80      | 53                  | 122               | 2.44    | 100                 | 2.20          | 6282-0500 | N3 |
| 750         | 94      | 53                  | 130               | 2.75    | 108                 | 2.67          | 6282-0750 | N3 |
| 1000        | 100     | 67                  | 153               | 3.05    | 75                  | 2.95          | 6282-1000 | N3 |
| 1500        | 114     | 67                  | 173               | 3.96    | 48                  | 3.55          | 6282-1500 | N3 |
| 2000        | 126     | 67                  | 192               | 4.94    | 40                  | 4.47          | 6282-2000 | N3 |

## Wide-necked boxes, square shaped | clear or brown material



The wide opening of the container enables easy filling with liquid, powder or granules such as tablets, capsules, dyes, shipments of samples, specimens etc. Also suitable for gift packages and hobby articles. For light-sensitive material, brown transparent wide-necked containers are particularly suited.

- ▶ PETG crystal-clear
- ▶ PVC highly transparent or brown transparent
- ▶ Screw lid PP, black, seal made of PE

### Wide-necked boxes, square shaped

| Material               | Capacity ml | Length mm | Width mm | Height with cap mm | Neck dia. inside mm | Price € | Quantity scale from | Scale price € | Item no.     |
|------------------------|-------------|-----------|----------|--------------------|---------------------|---------|---------------------|---------------|--------------|
| PETG crystal clear     | 50          | 38        | 38       | 63                 | 23                  | 1.00    | 162                 | 0.93          | 0357-0050 N3 |
| PETG crystal clear     | 100         | 46        | 46       | 75                 | 31                  | 1.16    | 80                  | 1.04          | 0357-0100 N3 |
| PETG crystal clear     | 200         | 59        | 59       | 91                 | 41                  | 1.79    | 100                 | 1.61          | 0357-0200 N3 |
| PETG crystal clear     | 500         | 80        | 80       | 111                | 54                  | 2.60    | 100                 | 2.36          | 0357-0500 N3 |
| PETG crystal clear     | 1000        | 95        | 95       | 152                | 69                  | 3.40    | 96                  | 3.27          | 0357-1000 N3 |
| PVC highly transparent | 50          | 38        | 38       | 63                 | 23                  | 0.84    | 162                 | 0.74          | 0355-0050 N3 |
| PVC highly transparent | 100         | 46        | 46       | 75                 | 31                  | 0.97    | 80                  | 0.92          | 0355-0100 N3 |
| PVC highly transparent | 200         | 59        | 59       | 91                 | 41                  | 1.45    | 100                 | 1.33          | 0355-0200 N3 |
| PVC highly transparent | 300         | 66        | 66       | 98                 | 41                  | 1.61    | 100                 | 1.48          | 0355-0300 N3 |
| PVC highly transparent | 500         | 80        | 80       | 111                | 54                  | 2.12    | 100                 | 1.94          | 0355-0500 N3 |
| PVC highly transparent | 750         | 92        | 92       | 120                | 69                  | 2.53    | 114                 | 2.33          | 0355-0750 N3 |
| PVC highly transparent | 1000        | 95        | 95       | 152                | 69                  | 2.83    | 96                  | 2.60          | 0355-1000 N3 |
| PVC highly transparent | 2000        | 120       | 120      | 190                | 69                  | 4.63    | 44                  | 4.20          | 0355-2000 N3 |
| PVC amber transparent  | 100         | 46        | 46       | 75                 | 31                  | 0.96    | 80                  | 0.87          | 0356-0100 N3 |
| PVC amber transparent  | 200         | 59        | 59       | 91                 | 41                  | 1.44    | 100                 | 1.32          | 0356-0200 N3 |



## All-purpose tubes with screw cap



Contents can be recognised easily due to the transparent sides. Emptying without residues.

- ▶ PP, transparent, screw lid PE
- ▶ No crevices

### All-purpose tubes with screw cap; transparent

| Capacity ml | Container dia. mm | Height mm | Price € | Quantity scale from | Scale price € | Item no.     |
|-------------|-------------------|-----------|---------|---------------------|---------------|--------------|
| 250         | 104               | 50        | 3.69    | 25                  | 3.28          | 6202-0250 N3 |
| 500         | 104               | 100       | 4.75    | 14                  | 4.33          | 6202-0500 N3 |
| 1000        | 126               | 126       | 8.55    | 12                  | 7.90          | 6202-1000 N3 |

## All-purpose boxes, square



Box for storing, packing, taking samples, sampling and transport of pastes, granules, powders, soil samples and frozen goods (-40°C up to briefly + 95°C). Ideal use of space, can be stacked. Complete with press-in lid.

- ▶ PE, transparent
- ▶ Can be deep frozen
- ▶ No crevices

### All-purpose boxes, square shaped

| Capacity ml | L x W x H mm    | Price € | Quantity scale from | Scale price € | Item no.     |
|-------------|-----------------|---------|---------------------|---------------|--------------|
| 500         | 103 x 103 x 64  | 2.12    | 20                  | 1.93          | 6250-0500 N3 |
| 1000        | 103 x 103 x 127 | 3.28    | 16                  | 2.86          | 6250-1000 N3 |
| 1000        | 208 x 103 x 64  | 4.01    | 18                  | 3.64          | 6250-1001 N3 |
| 1500        | 208 x 103 x 94  | 5.35    | 20                  | 4.88          | 6250-1500 N3 |
| 2000        | 208 x 208 x 64  | 7.30    | 20                  | 6.45          | 6250-2000 N3 |
| 2000        | 255 x 103 x 94  | 6.55    | 20                  | 5.95          | 6250-2300 N3 |
| 3200        | 208 x 208 x 94  | 8.05    | 14                  | 7.40          | 6250-3300 N3 |

### All-purpose boxes, round

| Capacity ml | Outer dia. bottom mm | Outer dia. top mm | Height mm | Price € | Quantity scale from | Scale price € | Item no.     |
|-------------|----------------------|-------------------|-----------|---------|---------------------|---------------|--------------|
| 250         | 60                   | 78                | 90        | 2.59    | 60                  | 2.36          | 6210-0250 N3 |
| 500         | 75                   | 95                | 127       | 2.92    | 24                  | 2.67          | 6210-0500 N3 |
| 1000        | 118                  | 136               | 110       | 3.83    | 20                  | 3.40          | 6210-1001 N3 |
| 2000        | 148                  | 169               | 143       | 6.05    | 25                  | 5.50          | 6210-2000 N3 |

## Sample boxes, aseptic



Sample box with tightly closing sealing cover. The lid can be opened with one hand and its hinge angle is 90°. Liquid/condensate in the lid runs into an absorbing groove integrated in the lid, nothing is lost, nothing can drip. The box is completely tight, has no crevices, is therefore easy to fill and can be emptied without residues. The sample box is produced under aseptic conditions. It is autoclavable and suitable for deep freezing.

- ▶ PP, transparent
- ▶ Aseptic
- ▶ With area for labelling and graduation

**\* Bulk prices**

### Sample boxes, aseptic

| Capacity ml | Height mm | Dia. mm | Model                                     | Price € | Quantity scale from | Scale price € | Item no.  |    |
|-------------|-----------|---------|---|---------|---------------------|---------------|-----------|----|
| 50          | 78        | 31      | with labeling area and graduation         | 0.32    | 650                 | 0.30          | 6206-0060 | N3 |
| 90          | 80        | 43      | with labeling area and graduation at 80ml | 0.37    | 350                 | 0.34          | 6206-0100 | N3 |
| 300         | 88        | 75      | graduated                                 | 0.97    | 240                 | 0.90          | 6206-0300 | N3 |



## Sample tubes aseptic, with seal



The sample boxes are manufactured in the cleanroom and sealed in the injection moulding machine at over 100°C, so that the insides of the boxes are virtually sterile. This method makes the boxes absolutely leakproof, as the cap and box adapt ideally to each other during the cooling process. No crevices, therefore easy to fill and can be emptied without residues. With tamper-evident seal which guarantees virtual sterility until the first opening. After opening, it can be sealed again with a practical seal.

- ▶ PP, transparent
- ▶ Aseptic
- ▶ With graduation
- ▶ Sterilisable

### Sample tubes aseptic, with seal

| Capacity ml | Height mm | Dia. mm | Price € | Quantity scale from | Scale price € | Item no.  |    |
|-------------|-----------|---------|---------|---------------------|---------------|-----------|----|
| 55          | 84        | 29      | 0.35    | 90                  | 0.33          | 6207-0055 | N3 |
| 340         | 119       | 63      | 0.62    | 90                  | 0.55          | 6207-0340 | N3 |

## Sample container, round



Sample box with screw lid. Ideal for taking samples and transport. Available in two material qualities: highly transparent PP for powder, pastes, liquids, or PFA for super pure collection of samples. Emptying without residues because there are no crevices.

- ▶ PP or PFA autoclavable
- ▶ Thick sides
- ▶ Sample container PFA not suitable for food

### Sample container, round

| Material | Capacity ml | Inner dia. mm | Outer dia. mm | Height with cap mm | Price € | Quantity scale from | Scale price € | Item no.  |    |
|----------|-------------|---------------|---------------|--------------------|---------|---------------------|---------------|-----------|----|
| PP       | 60          | 35            | 50            | 93                 | 7.50    | 10                  | 6.55          | 6203-0060 | N3 |
| PP       | 180         | 50            | 65            | 119                | 10.80   | 10                  | 9.50          | 6203-0180 | N3 |
| PFA      | 90          | 50            | 65            | 65                 | 56.45   | 10                  | 51.45         | 6205-0090 | N3 |
| PFA      | 180         | 50            | 65            | 119                | 73.05   | 10                  | 64.80         | 6205-0180 | N3 |

## Sample beaker with cover



Sample beaker with liquid-tight red screw-on cover. The sample beakers are aseptic and suitable for use with food. The beakers can be autoclaved without the cover.

- ▶ PP beaker, LDPE cover
- ▶ Temperature resistance of beaker  $-20^{\circ}\text{C}/+120^{\circ}\text{C}$ , cover  $-80^{\circ}\text{C}/+75^{\circ}\text{C}$
- ▶ Aseptic

## SteriPlast® sampling tube



Sterile sampling tube with removable handle and tightly closing sealing cover. The lid can be opened with one hand and is then at a  $90^{\circ}$  angle. Liquid/condensate in the lid goes into an absorbing channel integrated into the lid, nothing is lost, nothing can drip. The sterile sampling tube with a handle of 24 cm in length enables a clean sample to be placed directly in the sampling container. This mainly prevents cross-contamination.

- ▶ Polypropylene, blue transparent
- ▶ Sterile, packed separately



### Sample beaker with cover

| Capacity ml | Dia. mm | Height mm | Price € | Quantity scale from | Scale price € | Item no.  |    |
|-------------|---------|-----------|---------|---------------------|---------------|-----------|----|
| 125         | 52      | 74        | 0.91    | 380                 | 0.73          | 7103-0125 | N3 |

### SteriPlast® sampling tube

| Capacity ml | Dia. mm | Height mm | Price € | Quantity scale from | Scale price € | Item no.  |    |
|-------------|---------|-----------|---------|---------------------|---------------|-----------|----|
| 90          | 43      | 80        | 3.28    | 150                 | 2.91          | 6206-0101 | N3 |

Flachmann - the compact jerrycan | for more content on less shelf width

**b** LaboPlast

**Flachmann - the compact jerrycan**

The compact jerrycan Flachmann is ideal as a space-saving canister with its width of 6.5 cm. Different liquids can be stored and decanted in a small space. Flachmann can also be stored lying on its side e. g. in a refrigerator. It is very stable due to ribbed structure and thick sides. Using the support stand for two or three canisters, any number of canisters can safely be placed in the open. The compact jerrycan can also be used as a settling canister.



①



②



③

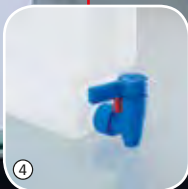

④



## Flachmann - the compact jerrycan | for more content on less shelf width



- ▶ With or without threaded connector 3/4"
- ▶ PP, transparent
- ▶ With tamper-proof closure
- ▶ Canister without valve autoclavable
- ▶ With moulded, indestructible litre graduation
- ▶ Canister support made of aluminium for secure stand as accessory
- ▶ Spigot StopCock with rotatable discharge angle and Compact spigot, which fits canisters equipped with glands with threads 3/4", available as accessory

### Flachmann - the compact jerrycan

| Model                        | Capacity l | Width mm | Depth mm | Height mm | Opening dia. mm | Price € | Quantity scale from | Scale price € | Item no.  |    |
|------------------------------|------------|----------|----------|-----------|-----------------|---------|---------------------|---------------|-----------|----|
| without threaded connector   | 5          | 65       | 335      | 335       | 41              | 27.40   | 10                  | 24.65         | 0435-1050 | N4 |
| with threaded connector 3/4" | 5          | 65       | 335      | 335       | 41              | 29.25   | 10                  | 26.20         | 0435-2050 | N4 |

### Accessories

| Description  | Price € | Item no.     |
|--|---------|--------------|
| ① Support stand for two compact jerrycans                        | 20.00   | 0435-9102 N4 |
| ① Support stand for three compact jerrycans                      | 21.30   | 0435-9103 N4 |
| ② Venting valve in screw cap                                     | 12.15   | 0435-9200 N4 |
| ③ StopCock angled (see page 44)                                  | 20.30   | 0525-1000 N4 |
| ④ Compact spigot (see page 45)                                   | 13.25   | 0530-1000 N4 |
| Closure cap 3/4"   | 4.84    | 0600-0090 N4 |
| ⑤ Set consisting of one compact jerrycan and one spigot Compact  | 38.50   | 0435-3000 N4 |
| ⑥ Set consisting of one compact jerrycan and one spigot StopCock | 46.50   | 0435-0001 N4 |



Canister for storage or transport. Canister with UN transport approval and tamper-evident seal.

- ▶ HDPE
- ▶ UN approval 3H1/X1.9/250 (see page 265)
- ▶ Screw lid with drain cock available as accessory

**\* Bulk prices**

## Jerrycans

| Capacity l | L x W x H mm    | Weight g | Neck dia. inside mm | Thread | Colour      | Price € | Quantity scale from | Scale price € | Item no.     |
|------------|-----------------|----------|---------------------|--------|-------------|---------|---------------------|---------------|--------------|
| 5          | 190 x 145 x 251 | 250      | 40,5                | DIN50  | transparent | 5.10    | 16                  | 4.58          | 1427-0005 N3 |
| 10         | 230 x 190 x 310 | 450      | 40,5                | DIN50  | transparent | 6.40    | 10                  | 5.70          | 1427-0010 N3 |
| 20         | 290 x 246 x 385 | 950      | 48,5                | DIN60  | blue        | 17.00   | 6                   | 15.50         | 1427-0020 N3 |
| 30         | 320 x 284 x 435 | 1250     | 48,5                | DIN60  | blue        | 24.45   | 6                   | 22.15         | 1427-0030 N3 |

## Accessories

| Description                                   | Price € | Item no.     |
|---|---------|--------------|
| Screw closure DIN50 with spigot for jerrycans | 7.25    | 1427-9102 N3 |
| Screw closure DIN60 with spigot for jerrycans | 8.05    | 1427-9100 N3 |
| Original screw cap DIN50                      | 0.57    | 1427-9105 N3 |
| Original screw cap DIN60                      | 1.14    | 1427-9106 N3 |

## Electrically conductive canister with UN approval

Canister made of electrically conductive HDPE for preventing ignition sources. The canisters are capable of diverting a charge (surface resistance  $<10^9$  ohms) and can be earthed, which makes them suitable for use with flammable liquids.

- ▶ HDPE, capable of diverting a charge
- ▶ With carrying handle and screw cap
- ▶ With UN approval for transport, see page 265
- ▶ Stackable

 Note the "List of Chemical Resistance"!



### Electrically conductive canister with UN approval

| Capacity l | L x W x H mm    | UN approval  | Thread | Weight g | Price € | Quantity scale from | Scale price € | Item no.  |  |
|------------|-----------------|--------------|--------|----------|---------|---------------------|---------------|-----------|---|
| 10         | 300 x 200 x 258 | 3H1/Y1.5/200 | DIN 61 | 770      | 26.25   | 16                  | 24.15         | 1428-0010 | N4  |
| 20         | 300 x 200 x 495 | 3H1/Y1.5/150 | DIN 61 | 1320     | 36.10   | 10                  | 33.25         | 1428-0020 | N4  |
| 30         | 364 x 240 x 455 | 3H1/Y1.5/150 | DIN 61 | 1350     | 42.70   | 5                   | 38.60         | 1428-0030 | N4  |

## Wide-necked jerrycans with/without threaded connector

Wide-necked canister with extremely wide filling opening (88 mm), easy to clean on the inside, which is particularly important when storing sensitive substances. Carrying handles and screw lid guarantee safe and convenient transport. The wide-necked canister can also be used as a settling canister. Via a threaded connector just above the base, a spigot or other accessories with an inner thread of 3/4" can be attached.

- ▶ HDPE, transparent
- ▶ UV stabilised
- ▶ Self-adhesive blue litre graduation and spigots available as accessory



### Wide-necked jerrycans with/without threaded connector

| Model                        | Capacity l | Width mm | Depth mm | Height mm | Ventilation dia. mm | Price € | Quantity scale from | Scale price € | Item no.  |    |  |  |
|------------------------------|------------|----------|----------|-----------|---------------------|---------|---------------------|---------------|-----------|----|--|--|
| without threaded connector   | 5          | 130      | 290      | 280       | 18                  | 24.75   | 6                   | 22.10         | 0431-0005 | N3 |  |  |
| without threaded connector   | 10         | 137      | 310      | 400       | 18                  | 35.20   | 5                   | 31.75         | 0431-0010 | N3 |  |  |
| without threaded connector   | 20         | 165      | 365      | 485       | -                   | 55.05   | 3                   | 49.50         | 0431-0020 | N3 |  |  |
| without threaded connector   | 30         | 240      | 365      | 485       | -                   | 69.20   | 2                   | 60.60         | 0431-0030 | N3 |  |  |
| with threaded connector 3/4" | 5          | 130      | 290      | 280       | 18                  | 31.75   | 6                   | 28.45         | 0431-1005 | N3 |  |  |
| with threaded connector 3/4" | 10         | 137      | 310      | 400       | 18                  | 45.55   | 5                   | 41.65         | 0431-1010 | N3 |  |  |
| with threaded connector 3/4" | 20         | 165      | 365      | 485       | -                   | 68.10   | 3                   | 59.75         | 0431-1020 | N3 |  |  |
| with threaded connector 3/4" | 30         | 240      | 365      | 485       | -                   | 81.65   | 2                   | 72.85         | 0431-1030 | N3 |  |  |

### Accessories

| Description                               | Price € | Item no.     |
|---|---------|--------------|
| Graduation for wide-necked jerrycans 5 l  | 5.25    | 0431-9051 N3 |
| Graduation for wide-necked jerrycans 10 l | 5.25    | 0431-9011 N3 |
| Graduation for wide-necked jerrycans 20 l | 5.25    | 0431-9021 N3 |
| Graduation for wide-necked jerrycans 30 l | 5.25    | 0431-9031 N3 |
| StopCock angled (see page 44)             | 20.30   | 0525-1000 N4 |
| Compact spigot (see page 45)              | 13.25   | 0530-1000 N4 |
| Closure cap 3/4"                          | 4.84    | 0600-0090 N4 |

## Storage bottles, with/without threaded connector

Robust storage bottle with particularly thick sides with sturdy carrying handle for safe transport and storage. Blue litre graduation printed on. The venting valve (accessory) lets air into the container in order to prevent a vacuum in the bottle. The canister can also be used as a settling canister. Via a threaded connector, a spigot or other accessories with an inner thread/cap nut of 3/4" can be attached.

- ▶ HDPE
- ▶ Bottle opening diameter 50 mm



### Storage bottles, with/without threaded connector

| Model                      | Capacity l | Container dia. mm | Height capless mm | Handles | Price € | Quantity scale from | Scale price € | Item no.     |
|----------------------------|------------|-------------------|-------------------|---------|---------|---------------------|---------------|--------------|
| without threaded connector | 5          | 167               | 330               | 1       | 25.60   | 11                  | 23.20         | 0401-0005 N3 |
| without threaded connector | 10         | 206               | 427               | 1       | 34.40   | 6                   | 31.20         | 0401-0010 N3 |
| without threaded connector | 25         | 278               | 580               | 2       | 71.10   | 5                   | 64.90         | 0401-0025 N3 |
| without threaded connector | 60         | 346               | 830               | 2       | 137.10  | 4                   | 125.60        | 0401-0060 N3 |
| with threaded connector    | 5          | 167               | 330               | 1       | 35.20   | 11                  | 32.05         | 0402-0005 N3 |
| with threaded connector    | 10         | 206               | 427               | 1       | 44.00   | 6                   | 39.70         | 0402-0010 N3 |
| with threaded connector    | 25         | 278               | 580               | 2       | 81.25   | 5                   | 74.85         | 0402-0025 N3 |
| with threaded connector    | 60         | 346               | 830               | 2       | 140.80  | 4                   | 130.70        | 0402-0060 N3 |

### Accessories

| Description                          | Price € | Item no.     |
|--------------------------------------|---------|--------------|
| Ventilation seal for storage bottles | 17.40   | 0401-9100 N3 |
| ① StopCock angled (see page 44)      | 20.30   | 0525-1000 N4 |
| ② Compact spigot (see page 45)       | 13.25   | 0530-1000 N4 |

## Wide-mouth containers with handle



Container with 2.3 l and 4.4 l contents and particularly wide opening. Therefore ideal for filling with bulk goods of all kinds. Products such as spices, tea, granulates can be packaged, stored or displayed as samples in these containers. Space-saving square shape.

- ▶ Safe handling with integral handle
- ▶ Transparent polyethylene provides good view of contents
- ▶ Leakproof wide-necked lid
- ▶ 0317-2300 with tamper-evident screw cap made of blue PP, 0317-4400 with screw cap made of LDPE

### Wide-mouth containers with handle

| Capacity ml | L x W mm  | Height with cap mm | Neck dia. inside mm | Thread dia. mm | Price € | Quantity scale from | Scale price € | Item no.     |  |  |  |
|-------------|-----------|--------------------|---------------------|----------------|---------|---------------------|---------------|--------------|--|--|--|
| 2300        | 135 x 135 | 192                | 68,5                | 80             | 8.65    | 36                  | 8.05          | 0317-2300 N3 |  |  |  |
| 4400        | 142 x 142 | 263                | 109                 | 120            | 10.70   | 52                  | 10.20         | 0317-4400 N3 |  |  |  |

## Universal storage containers



Practical storage containers with closed gripping edges for safe transport of pourable or liquid contents. Rounded inner edges and smooth inner surfaces for easy cleaning enable use in the food-stuffs/hygiene sector.

- ▶ HDPE, white
- ▶ Can be stacked

Attention! Make sure to pay attention to the "List of Chemical Resistance"!

### Universal storage containers

| Capacity l | Outer dimension of rim L x W x H mm | Inner dimension L x W x H mm | Price € | Quantity scale from | Scale price € | Item no.     |  |  |  |
|------------|-------------------------------------|------------------------------|---------|---------------------|---------------|--------------|--|--|--|
| 29         | 660 x 450 x 130                     | 600 x 400 x 120              | 28.35   | 10                  | 25.90         | 3418-0129 N2 |  |  |  |
| 48         | 660 x 450 x 220                     | 600 x 400 x 210              | 40.35   | 10                  | 36.70         | 3418-0148 N2 |  |  |  |
| 94         | 660 x 450 x 410                     | 600 x 400 x 400              | 60.75   | 10                  | 55.05         | 3418-0194 N2 |  |  |  |

### Accessories

| Description                                    | Price € | Item no.     |
|--|---------|--------------|
| Lid for universal storage containers, PS white | 18.85   | 3418-0001 N2 |

# Storage and stacking containers



Stable storage containers made of durable PP with external reinforcement ribs.

- ▶ Temperature resistant from -40°C to +90°C
- ▶ According to Euro standards
- ▶ Lid and transport rollers available as accessory



Transport roller



Lids for storage and stacking containers

## Storage and stacking containers

| Capacity l | Outer dimension of rim L x W x H mm | Inner dimension L x W x H mm | Price € | Quantity scale from | Scale price € | Item no.     |
|------------|-------------------------------------|------------------------------|---------|---------------------|---------------|--------------|
| 11         | 400 x 300 x 120                     | 367 x 267 x 116              | 17.95   | 10                  | 16.50         | 3414-0111 N2 |
| 17         | 400 x 300 x 180                     | 367 x 267 x 176              | 21.95   | 10                  | 20.10         | 3414-0117 N2 |
| 23         | 400 x 300 x 220                     | 367 x 267 x 216              | 29.15   | 10                  | 25.75         | 3414-0120 N2 |
| 23         | 600 x 400 x 120                     | 567 x 367 x 114              | 29.10   | 10                  | 26.55         | 3414-0123 N2 |
| 38         | 600 x 400 x 180                     | 567 x 367 x 176              | 37.05   | 10                  | 33.55         | 3414-0138 N2 |
| 45         | 600 x 400 x 220                     | 567 x 367 x 216              | 42.15   | 10                  | 38.40         | 3414-0148 N2 |
| 64         | 600 x 400 x 320                     | 567 x 367 x 316              | 49.15   | 10                  | 44.75         | 3414-0164 N2 |
| 80         | 600 x 400 x 420                     | 567 x 367 x 416              | 55.65   | 10                  | 50.60         | 3414-0181 N2 |



### Accessories

| Description                                      | Price € | Item no.     |
|--|---------|--------------|
| Lid for storage/stacking containers 400 x 300 mm | 11.20   | 3414-0001 N2 |
| Lid for storage/stacking containers 600 x 400 mm | 17.95   | 3414-0002 N2 |

### Transport trolley for containers

| Model            | Price € | Quantity scale from | Scale price € | Item no.     |
|------------------|---------|---------------------|---------------|--------------|
| for 600 x 400 mm | 79.70   | 10                  | 72.40         | 3414-9900 N2 |

## Tubs, round



Tub for every purpose, with strong edge and practical carrying handles for safe transport. A lid can be delivered for every tub.

- ▶ Tub made of HDPE
- ▶ Temperature resistant from -30° to +70°
- ▶ Suitable for food
- ▶ High degree of chemical resistance

**!** Attention! Make sure to pay attention to the "List of Chemical Resistance"!

| Tubs, round |                       |         |              |
|-------------|-----------------------|---------|--------------|
| Capacity l  | Dia. top/below x H mm | Price € | Item no.     |
| 40          | 370/330 x 440         | 44.20   | 3482-0040 N3 |
| 50          | 370/330 x 555         | 52.70   | 3482-0050 N3 |
| 75          | 460/400 x 535         | 63.15   | 3482-0075 N3 |
| 110         | 460/420 x 710         | 132.15  | 3482-0110 N3 |

| Accessories                           |         |           |    |
|---------------------------------------|---------|-----------|----|
| Description                           | Price € | Item no.  |    |
| Lids for tubs, round, for 370 mm dia. | 10.80   | 3482-0401 | N3 |
| Lids for tubs, round, for 460 mm dia. | 24.35   | 3482-0751 | N3 |

## Mixing/dosing container



The containers close completely tight. They have thick sides, they are seamless, impact resistant and stressfree sintered. The wide-necked opening enables safe filling.

- ▶ LDPE
- ▶ With 3/4" inner thread at the container base
- ▶ Opening Ø 150 mm
- ▶ Suitable for food

| Mixing/dosing container |         |           |            |         |              |
|-------------------------|---------|-----------|------------|---------|--------------|
| Capacity l              | Dia. mm | Height mm | Division l | Price € | Item no.     |
| 60                      | 450     | 600       | 10         | 137.05  | 3460-0060 N2 |
| 100                     | 465     | 850       | 10         | 185.30  | 3460-0100 N2 |
| 200                     | 560     | 1020      | 20         | 296.40  | 3460-0200 N2 |
| 500                     | 815     | 1140      | 50         | 567.90  | 3460-0500 N2 |



## Disposal kegs, wide-mouth containers



The wide-necked container is approved for bulk goods. Used for disposal or storage. For liquids, powders or granules. Can be closed tightly and sealed.

- ▶ HDPE
- ▶ Temperature resistant from -20°C to + 80°C
- ▶ UN transport approval 1H2/X, see page 265

### Disposal kegs, wide-mouth containers

| Capacity l | Container dia. mm | Height with cap mm | Opening dia. mm | Price € | Quantity scale from | Scale price € | Item no.  |    |  |  |
|------------|-------------------|--------------------|-----------------|---------|---------------------|---------------|-----------|----|--|--|
| 3,6        | 198               | 171                | 136             | 14.40   | 10                  | 13.05         | 1105-0003 | N3 |  |  |
| 6          | 198               | 263                | 136             | 18.50   | 10                  | 16.80         | 1105-0006 | N3 |  |  |
| 10         | 274               | 238                | 203             | 25.75   | 10                  | 25.35         | 1105-0010 | N3 |  |  |
| 26         | 316               | 425                | 203             | 42.95   | 10                  | 38.90         | 1105-0026 | N3 |  |  |
| 34         | 338               | 449                | 295             | 48.70   | 10                  | 44.55         | 1105-0033 | N3 |  |  |

### Accessories

| Description                      | Price € | Item no.     |
|----------------------------------|---------|--------------|
| SampleSafe seal, red, 100 pieces | 70.55   | 5399-2902 N2 |

## Wide-mouth containers, HDPE



Storage or transport container made of HDPE. For liquids, powders or granules. Can be closed tightly.

Keep the container upright when transporting liquids!

### Wide-mouth containers, HDPE

| Capacity l | Container dia. mm | Height with cap mm | Opening dia. mm | Price € | Quantity scale from | Scale price € | Item no.  |    |  |
|------------|-------------------|--------------------|-----------------|---------|---------------------|---------------|-----------|----|--|
| 5          | 192               | 250                | 110             | 24.55   | 14                  | 23.60         | 1406-1005 | N3 |  |
| 10         | 232               | 325                | 110             | 34.15   | 6                   | 33.10         | 1406-1010 | N3 |  |

# Containers, rectangular and round shaped



**!** Depending on temperature and the expected contents, the rectangular containers may have to be strengthened with a frame. Kindly you ask us.

**LaboPlast**





Container for various applications. Produced seamlessly and stress-relieved with the LaboPlast® sintering method. The wall thickness increases downwardly. This guarantess optimum ratio of wall thickness to filling load. The containers are also colored black for UV-protection and are available in other wall thicknesses. Custom-made, exchange excluded.

- ▶ L-LDPE (linear LDPE), transparent
- ▶ Rupture-proof





We will mount the container connector directly into the container for you. The thread connectors are possible anywhere. Please state the exact position on the container, if applicable.

| Container thread              |        |         |              |
|-------------------------------|--------|---------|--------------|
| Model                         | Thread | Price € | Item no.     |
| Container thread              | 3/4"   | 40.55   | 3440-0034 N2 |
| Accessories                   |        |         |              |
| Description                   |        | Price € | Item no.     |
| StopCock angled (see page 44) |        | 20.30   | 0525-1000 N4 |
| Compact spigot (see page 45)  |        | 13.25   | 0530-1000 N4 |



## Containers, rectangular

| Capacity l | Inner dimension<br>L x W x H mm | Wall thickness mm | Price € | Item no.  |  |  |  |  |
|------------|---------------------------------|-------------------|---------|-----------|---|---|---|---|
| 13         | 220 x 220 x 410                 | 5                 | 95.77   | 3440-0135 | N2  |   |   |   |
| 23         | 540 x 370 x 130                 | 5                 | 112.49  | 3440-0235 | N2  |   |   |   |
| 40         | 390 x 190 x 620                 | 5                 | 127.90  | 3440-0405 | N2  |   |   |   |
| 45         | 600 x 600 x 165                 | 5                 | 131.93  | 3440-0455 | N2  |   |   |   |
| 48         | 400 x 400 x 300                 | 5                 | 122.89  | 3440-0485 | N2  |   |   |   |
| 50         | 1000 x 320 x 160                | 5                 | 127.91  | 3440-0505 | N2  |   |   |   |
| 56         | 315 x 315 x 635                 | 5                 | 139.66  | 3440-0565 | N2  |   |   |   |
| 70         | 460 x 310 x 570                 | 5                 | 153.77  | 3440-0705 | N2  |   |   |   |
| 85         | 600 x 340 x 480                 | 5                 | 168.04  | 3440-0855 | N2  |   |   |   |
| 90         | 600 x 400 x 410                 | 6                 | 182.20  | 3440-0906 | N2  |   |   |   |
| 100        | 780 x 460 x 320                 | 6                 | 195.15  | 3440-1006 | N2  |   |   |   |
| 115        | 500 x 400 x 600                 | 6                 | 206.75  | 3440-1156 | N2  |   |   |   |
| 118        | 600 x 250 x 820                 | 6                 | 221.07  | 3440-1186 | N2  |   |   |   |
| 130        | 710 x 330 x 560                 | 6                 | 219.66  | 3440-1306 | N2  |   |   |   |
| 150        | 600 x 400 x 630                 | 6                 | 233.92  | 3440-1506 | N2  |   |   |   |
| 155        | 600 x 500 x 560                 | 6                 | 245.68  | 3440-1556 | N2  |   |   |   |
| 165        | 780 x 500 x 420                 | 6                 | 240.45  | 3440-1656 | N2  |   |   |   |
| 190        | 600 x 400 x 800                 | 6                 | 277.81  | 3440-1906 | N2  |   |   |   |
| 250        | 1000 x 600 x 450                | 6                 | 329.44  | 3440-2506 | N2  |   |   |   |
| 260        | 800 x 600 x 600                 | 7                 | 387.75  | 3440-2607 | N2  |   |   |   |
| 285        | 600 x 600 x 820                 | 7                 | 405.62  | 3440-2857 | N2  |   |   |   |
| 320        | 1000 x 400 x 800                | 7                 | 440.57  | 3440-3207 | N2  |   |   |   |
| 400        | 860 x 560 x 840                 | 7                 | 503.74  | 3440-4007 | N2  |   |   |   |



## Containers, round shaped

| Capacity l | Inner dia. mm | Height mm | Wall thickness mm | Price € | Item no.  |  |  |  |  |
|------------|---------------|-----------|-------------------|---------|-----------|---|---|---|---|
| 14         | 245           | 325       | 5                 | 87.99   | 3490-0144 | N2  |   |   |   |
| 25         | 310           | 390       | 5                 | 95.77   | 3490-0254 | N2  |   |   |   |
| 30         | 310           | 430       | 5                 | 98.39   | 3490-0305 | N2  |   |   |   |
| 35         | 320           | 530       | 5                 | 105.96  | 3490-0355 | N2  |   |   |   |
| 50         | 410           | 480       | 5                 | 114.25  | 3490-0505 | N2  |   |   |   |
| 55         | 310           | 915       | 5                 | 127.91  | 3490-0555 | N2  |   |   |   |
| 60         | 410           | 530       | 5                 | 118.00  | 3490-0605 | N2  |   |   |   |
| 80         | 430           | 590       | 5                 | 127.91  | 3490-0805 | N2  |   |   |   |
| 85         | 390           | 710       | 5                 | 129.55  | 3490-0855 | N2  |   |   |   |
| 100        | 470           | 680       | 5                 | 144.78  | 3490-1005 | N2  |   |   |   |
| 110        | 540           | 540       | 6                 | 153.60  | 3490-1106 | N2  |   |   |   |
| 120        | 470           | 720       | 6                 | 159.95  | 3490-1206 | N2  |   |   |   |
| 145        | 600           | 510       | 6                 | 165.00  | 3490-1456 | N2  |   |   |   |
| 150        | 550           | 730       | 6                 | 185.35  | 3490-1506 | N2  |   |   |   |
| 160        | 460           | 1020      | 6                 | 193.90  | 3490-1606 | N2  |   |   |   |
| 180        | 540           | 820       | 6                 | 200.38  | 3490-1806 | N2  |   |   |   |
| 200        | 560           | 840       | 6                 | 208.10  | 3490-2006 | N2  |   |   |   |
| 205        | 800           | 440       | 6                 | 214.54  | 3490-2056 | N2  |   |   |   |
| 210        | 540           | 950       | 6                 | 223.47  | 3490-2106 | N2  |   |   |   |
| 250        | 550           | 1040      | 6                 | 245.68  | 3490-2506 | N2  |   |   |   |
| 290        | 740           | 770       | 6                 | 293.15  | 3490-2906 | N2  |   |   |   |
| 300        | 690           | 830       | 6                 | 284.40  | 3490-3006 | N2  |   |   |   |
| 400        | 760           | 1050      | 6                 | 435.00  | 3490-4006 | N2  |   |   |   |
| 850        | 970           | 1170      | 7                 | 798.28  | 3490-8507 | N2  |   |   |   |

## Lid for containers, rectangular

| Model               | Price € | Item no.  |  |  |  |
|---------------------|---------|-----------|---|---|---|
| for 13 l container  | 54.10   | 3440-0131 | N2  |   |   |
| for 23 l container  | 114.25  | 3440-0231 | N2  |   |   |
| for 40 l container  | 76.23   | 3440-0401 | N2  |   |   |
| for 45 l container  | 151.00  | 3440-0451 | N2  |   |   |
| for 48 l container  | 104.05  | 3440-0481 | N2  |   |   |
| for 50 l container  | 161.56  | 3440-0501 | N2  |   |   |
| for 56 l container  | 87.55   | 3440-0561 | N2  |   |   |
| for 70 l container  | 103.40  | 3440-0701 | N2  |   |   |
| for 85 l container  | 122.89  | 3440-0851 | N2  |   |   |
| for 90 l container  | 120.18  | 3440-0901 | N2  |   |   |
| for 100 l container | 153.77  | 3440-1001 | N2  |   |   |
| for 118 l container | 109.88  | 3440-1181 | N2  |   |   |
| for 130 l container | 131.93  | 3440-1301 | N2  |   |   |
| for 150 l container | 127.91  | 3440-1501 | N2  |   |   |
| for 155 l container | 140.92  | 3440-1551 | N2  |   |   |
| for 165 l container | 163.75  | 3440-1651 | N2  |   |   |
| for 190 l container | 127.91  | 3440-1901 | N2  |   |   |
| for 250 l container | 217.05  | 3440-2501 | N2  |   |   |
| for 260 l container | 179.69  | 3440-2601 | N2  |   |   |
| for 285 l container | 161.56  | 3440-2851 | N2  |   |   |
| for 320 l container | 200.38  | 3440-3201 | N2  |   |   |
| for 400 l container | 201.35  | 3440-4001 | N2  |   |   |

## Lid for containers, round shaped

| Model               | Price € | Item no.  |  |  |  |
|---------------------|---------|-----------|---|---|---|
| for 14 l container  | 50.89   | 3490-0141 | N2  |   |   |
| for 25 l container  | 50.89   | 3490-0251 | N2  |   |   |
| for 30 l container  | 49.95   | 3490-0301 | N2  |   |   |
| for 35 l container  | 59.41   | 3490-0351 | N2  |   |   |
| for 50 l container  | 59.41   | 3490-0501 | N2  |   |   |
| for 55 l container  | 49.95   | 3490-0551 | N2  |   |   |
| for 60 l container  | 58.35   | 3490-0601 | N2  |   |   |
| for 80 l container  | 59.41   | 3490-0801 | N2  |   |   |
| for 85 l container  | 58.35   | 3490-0851 | N2  |   |   |
| for 100 l container | 59.41   | 3490-1001 | N2  |   |   |
| for 110 l container | 73.83   | 3490-1101 | N2  |   |   |
| for 120 l container | 58.35   | 3490-1201 | N2  |   |   |
| for 145 l container | 73.83   | 3490-1451 | N2  |   |   |
| for 150 l container | 72.50   | 3490-1501 | N2  |   |   |
| for 160 l container | 59.41   | 3490-1601 | N2  |   |   |
| for 180 l container | 73.83   | 3490-1801 | N2  |   |   |
| for 200 l container | 72.50   | 3490-2001 | N2  |   |   |
| for 205 l container | 112.95  | 3490-2051 | N2  |   |   |
| for 210 l container | 72.50   | 3490-2101 | N2  |   |   |
| for 250 l container | 72.50   | 3490-2501 | N2  |   |   |
| for 290 l container | 88.95   | 3490-2901 | N2  |   |   |
| for 300 l container | 88.95   | 3490-3001 | N2  |   |   |
| for 400 l container | 88.95   | 3490-4001 | N2  |   |   |
| for 850 l container | 200.40  | 3490-8501 | N2  |   |   |

## Safety jerrycans stainless steel



- ▶ 0.8 mm sides
- ▶ Handles made of solid stainless steel
- ▶ Closure thread 1 1/2"
- ▶ Seals made of PTFE
- ▶ Accredited for UN-transport according to ADR, RID, IMDG Code, ICAO-TI, GGVSEB, GGVSee

Safety canister for transport and storage made of stainless steel 1.4571 for 5 l and 10 l canisters and 1.4301 for 20 l canisters.

Protection from exploding through flame protection and excess pressure valve. The containers have a high degree of chemical resistance and they save space.

In canisters with excess pressure valve, pressure balance takes place from about 0.3 bar.

Safety canister with self-closing fine dosage spout 20 l: with separate ventilation. Canisters with a venting screw enable manual air supply when used or manual pressure balance during storage.

## Safety cans stainless steel



- ▶ Stainless steel V4A (1.4571), 0.6 mm thickness
- ▶ Seals made of PTFE
- ▶ Handle made of powder-surfaced aluminium
- ▶ Closure thread 1 1/4"

For safe metering and handling of smaller amounts of flammable liquids. Protection from exploding through flame protection and excess pressure valve, the containers have a high degree of chemical resistance.

Can with removable flame protection in the filling connector and excess pressure valve in the self-closing fine dosage spout (pressure balance from about 0.3 bar).

### Safety jerrycans stainless steel

| Model  | Capacity l | Purpose   | L x W x H mm    | UN approval  | Price € | Item no.     |
|--|------------|-----------|-----------------|--------------|---------|--------------|
| with screw cap without pressure-relief valve               | 10         | transport | 280 x 130 x 380 | 3A1/X1.6/300 | 379.10  | 2601-7010 N2 |
| with screw cap and pressure-relief valve                   | 5          | storage   | 200 x 130 x 310 | no           | 324.70  | 2601-3005 N2 |
| with screw cap and pressure-relief valve                   | 10         | storage   | 280 x 130 x 380 | no           | 387.55  | 2601-3010 N2 |
| with screw cap and pressure-relief valve                   | 20         | storage   | 345 x 175 x 470 | no           | 474.05  | 2601-3020 N2 |
| with fine dosage spout incl. pressure-relief valve         | 10         | storage   | 280 x 130 x 380 | no           | 440.80  | 2601-2010 N2 |
| with fine dosage spout, pressure-relief valve, ventilation | 20         | storage   | 345 x 175 x 470 | no           | 516.10  | 2601-2020 N2 |

### Safety cans stainless steel

| Capacity l | Dia. mm | Height mm | Purpose | UN approval | Price € | Item no.     |
|------------|---------|-----------|---------|-------------|---------|--------------|
| 1          | 111     | 235       | storage | no          | 266.70  | 2601-1001 N2 |
| 2          | 131     | 295       | storage | no          | 288.55  | 2601-1002 N2 |
| 5          | 165     | 400       | storage | no          | 308.65  | 2601-1005 N2 |

## Safety storage container stainless steel

Safety containers for transport and storage made of high-quality stainless steel 1.4301 / 1.4571 with thickness of sides of 0.8mm (10 l), 1.2mm (25 l) and 1.5mm (50 l). The 25 l container can be stacked. Protection from exploding through flame protection and excess pressure valve, seals made of PTFE, the containers have a high degree of chemical resistance. In safety containers with excess pressure valve, pressure balance takes place from about 0.3 bar. For containers with self-closing tap, constant ventilation can be set via a plastic lever on the screw cap. The contents display made of perfluoroalkoxy copolymers (PFA) enables a visual contents check when filling and emptying.

- ▶ Accredited for UN-transport according to ADR, RID, IMDG Code, ICAO-TI, GGVSEB, GGVSee



### Safety storage container stainless steel

| Model   | Capacity l | Purpose           | Height mm | Thread   | Dia. mm | UN approval  | Thread, outflowing side | Price € | Item no.     |
|---|------------|-------------------|-----------|----------|---------|--------------|-------------------------|---------|--------------|
| with screw cap, without pressure-relief valve       | 25         | transport/storage | 530       | 1 1/2"   | 300     | 1A1/X1.6/400 | -                       | 472.95  | 2601-5125 N2 |
| with screw cap and pressure-relief valve            | 50         | storage           | 600       | 2" (TPI) | 380     | no           | -                       | 561.70  | 2601-5050 N2 |
| with tab and pressure-relief valve                  | 10         | storage           | 350       | 1 1/2"   | 260     | no           | 3/4"                    | 672.90  | 2601-4010 N2 |
| with tab and pressure-relief valve                  | 25         | storage           | 530       | 1 1/2"   | 300     | no           | 3/4"                    | 797.45  | 2601-4025 N2 |
| with tab, pressure-relief valve and level indicator | 10         | storage           | 350       | 1 1/2"   | 260     | no           | 3/4"                    | 927.10  | 2601-6010 N2 |



## Packaging bucket



Packaging bucket for transport, packaging and storing of various materials. Suitable for the food or building material industries and non-aggressive chemicals in environmental protection, hospitals and the household. With strong handle. Quality closure on the bucket for product safety.

- ▶ PP, white
- ▶ Air-tight closure
- ▶ Complete with lid
- ▶ With advertising printing in large quantities on request

**\* Bulk prices**

### Packaging bucket

| Capacity l | Dia. top mm | Height with cap mm | Price € | Quantity scale from | Scale price € | Item no.  |    |  |  |
|------------|-------------|--------------------|---------|---------------------|---------------|-----------|----|--|--|
| 1          | 132         | 131                | 1.21    | 100                 | 1.09          | 2327-0001 | N3 |  |  |
| 2          | 175         | 132                | 1.90    | 80                  | 1.75          | 2327-0020 | N3 |  |  |
| 3          | 225         | 123                | 2.40    | 45                  | 2.18          | 2327-0030 | N3 |  |  |
| 5          | 225         | 194                | 3.06    | 36                  | 2.71          | 2327-0050 | N3 |  |  |
| 10         | 268         | 263                | 4.09    | 25                  | 3.74          | 2327-0010 | N3 |  |  |

## Packaging bags with closure



Bags with the "zipper" closure for storing, collecting, protecting and shipping of specimens, samples and sales products. Contents remain dust-free. The film is waterproof and has good tear resistance.

- ▶ LDPE, crystal-clear
- ▶ 0.05 mm strong film

**\* Bulk prices**

### Packaging bags with closure

| L x W mm  | Volume ml | Pieces per pack | Price € | Quantity scale from | Scale price € | Item no.  |    |  |  |
|-----------|-----------|-----------------|---------|---------------------|---------------|-----------|----|--|--|
| 100 x 70  | 80        | 100             | 7.95    | 10                  | 7.35          | 2348-0002 | N3 |  |  |
| 130 x 60  | 100       | 100             | 5.10    | 10                  | 4.63          | 2348-0001 | N3 |  |  |
| 120 x 80  | 140       | 100             | 5.80    | 10                  | 5.30          | 2348-0003 | N3 |  |  |
| 150 x 100 | 300       | 100             | 7.05    | 10                  | 6.40          | 2348-0004 | N3 |  |  |
| 170 x 120 | 400       | 100             | 9.05    | 10                  | 8.35          | 2348-0005 | N3 |  |  |
| 220 x 160 | 1000      | 100             | 11.80   | 10                  | 10.90         | 2348-0006 | N3 |  |  |
| 250 x 180 | 1500      | 100             | 12.95   | 10                  | 11.90         | 2348-0007 | N3 |  |  |
| 300 x 200 | 2500      | 100             | 16.15   | 10                  | 14.75         | 2348-0008 | N3 |  |  |
| 350 x 250 | 4500      | 100             | 21.00   | 10                  | 18.80         | 2348-0009 | N3 |  |  |
| 400 x 300 | 6500      | 100             | 24.00   | 10                  | 21.80         | 2348-0010 | N3 |  |  |

## SteriBag StandUp sample bag



SteriBag StandUp is a sterile sample bag with a stand-up base. The special bottom unfolds as soon as the bag is filled. This makes SteriBag StandUp stable and able to stand on its own without a separate stand or support, leaving both your hands free to take the sample and fill the bag. The wire bracket at the closure keeps the bag open, making it easy and convenient to fill.

The sample bag is the ideal space-saving, unbreakable, inexpensive and sterile replacement for bottles and beakers.

Can be used for samples available as liquids, powders, solids and pastes; suitable for foods and can be frozen.

The stable standing SteriBag StandUp sample bag is easy and safe to transport.

SteriBag StandUp, the sample bag for easy handling of samples.



### SteriBag StandUp sample bag

| Capacity ml | L x W mm | Pieces per pack | Price € | Quantity scale from | Scale price € | Item no.  |    |
|-------------|----------|-----------------|---------|---------------------|---------------|-----------|----|
| 400         | 229x114  | 500             | 179.25  | 5                   | 170.25        | 5344-0400 | N3 |
| 600         | 229x152  | 500             | 187.35  | 5                   | 177.95        | 5344-0600 | N3 |

**Bulk prices**

## Sampling bag SteriBag



The sterilised sampling bag SteriBag for samples in chemistry, pharmaceuticals, medicine, veterinary science and foodstuffs etc. The bags are made of Polyethylene and are therefore exceptionally tearproof and leakproof. See page 132.

### Sampling bag SteriBag

| Ca-<br>capacity<br>ml | Model                  | L x W mm  | Pieces<br>per<br>pack | Price € | Quantity<br>scale<br>from | Scale<br>price € | Item no.  |    |
|-----------------------|------------------------|-----------|-----------------------|---------|---------------------------|------------------|-----------|----|
| 60                    | without labelling area | 127 x 76  | 500                   | 112.50  | 6                         | 106.55           | 5344-0060 | N3 |
| 60                    | with labelling area    | 127 x 76  | 500                   | 122.25  | 6                         | 116.20           | 5344-0061 | N3 |
| 150                   | without labelling area | 178 x 76  | 500                   | 116.20  | 6                         | 108.90           | 5344-0180 | N3 |
| 150                   | with labelling area    | 178 x 76  | 500                   | 125.90  | 6                         | 119.75           | 5344-0181 | N3 |
| 450                   | without labelling area | 229 x 114 | 500                   | 136.70  | 6                         | 130.70           | 5344-0540 | N3 |
| 450                   | with labelling area    | 229 x 114 | 500                   | 145.15  | 6                         | 136.70           | 5344-0541 | N3 |
| 650                   | without labelling area | 229 x 140 | 500                   | 152.45  | 6                         | 143.95           | 5344-0720 | N3 |
| 650                   | with labelling area    | 229 x 140 | 500                   | 174.20  | 6                         | 166.95           | 5344-0721 | N3 |
| 900                   | without labelling area | 305 x 114 | 500                   | 158.55  | 6                         | 151.25           | 5344-0810 | N3 |
| 900                   | with labelling area    | 305 x 114 | 500                   | 168.15  | 6                         | 159.75           | 5344-0811 | N3 |
| 1650                  | without labelling area | 305 x 178 | 250                   | 121.00  | 12                        | 116.20           | 5344-1650 | N3 |
| 1650                  | with labelling area    | 305 x 178 | 250                   | 136.70  | 12                        | 125.90           | 5344-1651 | N3 |

## Table of contents industrial & laboratory equipment



- 200 – 207 Trays, bowls, buckets
- 208 – 210 Funnels
- 211 – 217 Graduated beakers
- 218 – 219 Titrating burettes
- 220 – 223 Pipettes, pipetting aids, pipette cleaning
- 224 – 225 Draining & test-tube racks
- 226 Snow Pack® dry ice machine
- 227 – 237 Tubings, connectors, flow indicators
- 238 – 243 Hose clamps, two-way and three way valves, non-return valves
- 244 – 249 Hose couplings
- 250 – 253 Threaded fittings
- 254 – 256 Vacuum pumps, water-jet pumps, dessicator
- 256 – 258 Protective equipment
- 259 – 261 Bungs, stirring, mixing



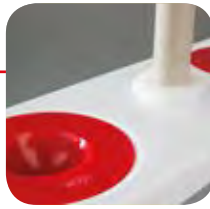

## Industrial & laboratory equipment

Connectors, fittings, funnels, measuring

## All-purpose trays | hygienic, easy to clean



The laboratory trays are practical all-purpose trays that can be nested when empty, also durable, shatter-proof and resist flexing. The trays have a strong, rounded rim.

Suitable as a spill trough for environmentally dangerous, aggressive substances, for experiments, as an etching tray, as an instrument holder, a medicine tray, a photographic development basin, a goods presentation tray and a display tray for foodstuffs.

- ▶ PP, white
- ▶ Manufactured using the injection moulding process, not by deep drawing
- ▶ Trays can be nested
- ▶ Tray not suitable for temperature controlled cupboards or dishwashers
- ▶ Temperature resistant up to +60 °C (briefly up to +80 °C)



### Laboratory trays / spill throughs separate

| Capacity l | Inner dimension of base<br>L x W mm | Outer dimension of<br>base L x W mm | Outer dimension of rim<br>L x W x H mm | Price € | Quantity scale from | Scale price € | Item no.     |
|------------|-------------------------------------|-------------------------------------|--|---------|---------------------|---------------|--------------|
| 0.5        | 130 x 180                           | 140 x 190                           | 180 x 230 x 42                         | 4.78    | 10                  | 4.37          | 4201-1318 N4 |
| 1.5        | 180 x 240                           | 190 x 250                           | 250 x 310 x 65                         | 8.50    | 10                  | 7.80          | 4201-1824 N4 |
| 3.0        | 240 x 300                           | 250 x 310                           | 310 x 370 x 75                         | 12.35   | 10                  | 11.35         | 4201-2430 N4 |
| 10         | 300 x 400                           | 310 x 410                           | 420 x 520 x 120                        | 20.05   | 10                  | 18.35         | 4201-3040 N4 |
| 21         | 400 x 500                           | 430 x 530                           | 534 x 634 x 140                        | 34.85   | 5                   | 31.95         | 4201-4050 N4 |
| 39         | 500 x 700                           | 520 x 720                           | 648 x 846 x 160                        | 50.85   | 5                   | 46.25         | 4201-5070 N4 |

### Accessories

| Description   | Price € | Item no.     |
|---|---------|--------------|
| Laboratory trays / spill throughs set - 4 piece set | 40.85   | 4201-0095 N4 |
| Laboratory trays / spill throughs set - 6 piece set | 117.55  | 4201-0100 N4 |

# Laboratory trays / spill troughs set

## Laboratory trays / Spill troughs in a beneficial set

Laboratory tray set of 4 with one tray each:

- ▶ 0.5 l (L x W x H 180 x 230 x 42 mm)
- ▶ 1.5 l (L x W x H 250 x 310 x 65 mm)
- ▶ 3.0 l (L x W x H 310 x 370 x 75 mm)
- ▶ 10.0 l (L x W x H 420 x 520 x 120 mm)

Laboratory tray set of 6 with one tray each:

- ▶ 0.5 l (L x W x H 180 x 230 x 42 mm)
- ▶ 1.5 l (L x W x H 250 x 310 x 65 mm)
- ▶ 3.0 l (L x W x H 310 x 370 x 75 mm)
- ▶ 10.0 l (L x W x H 420 x 520 x 120 mm)
- ▶ 21.0 l (L x W x H 534 x 634 x 140 mm)
- ▶ 39.0 l (L x W x H 648 x 846 x 160 mm)



### Laboratory trays / spill troughs set

| Model       | Capacity l | Price € | Quantity scale from | Scale price € | Item no.     |
|-------------|------------|---------|---------------------|---------------|--------------|
| 4 piece set | 0.5 – 10   | 40.85   | 10                  | 38.85         | 4201-0095 N4 |
| 6 piece set | 0.5 – 39   | 117.55  | 10                  | 111.40        | 4201-0100 N4 |



## Photographic trays | in a variety of colours and sizes



These photographic trays made of PVC are available in a variety of shapes and colours. Available in shallow or deep models, with or without ribs on the base, in 3 attractive, high-gloss colours: white, red and black. The model with ribs on the base is especially well suited as a film development tray. The raised ribs prevent photographic paper from sticking to the base of the tray. Liquid can be poured out easily from the tray edges. The model without ribs on the base is suited for universal laboratory or storage purposes. Important: the photographic trays are made of high-quality PVC.

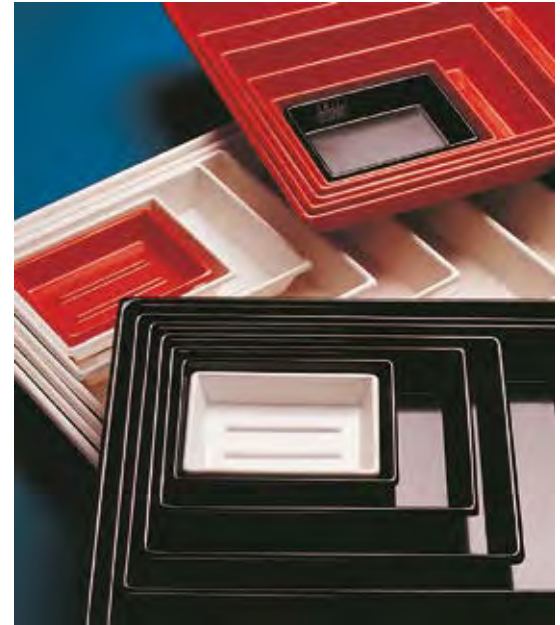

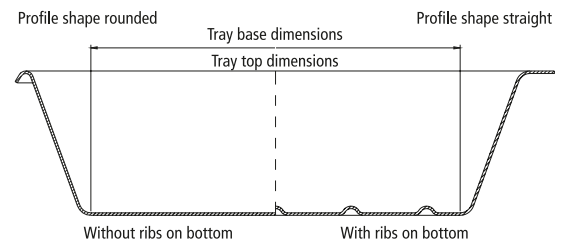

- ▶ PVC
- ▶ Thick sides, shatterproof
- ▶ Largely resistant to acids and alkalis
- ▶ Tray not suitable for temperature controlled cupboards or dishwashers
- ▶ Temperature resistant from -30 °C up to max. +60 °C



## Photographic trays | in a variety of colours and sizes

| Photographic trays, shallow form with ribs on bottom, profile shape rounded  |                                  |                                 |           |         |                     |               |           |    |
|---|----------------------------------|---------------------------------|-----------|---------|---------------------|---------------|-----------|----|
| Colour  | Inner dimension of base L x W mm | Outer dimension of rim L x W mm | Height mm | Price € | Quantity scale from | Scale price € | Item no.  |    |
| white   | 140 x 190                        | 180 x 230                       | 40        | 7.75    | 5                   | 7.10          | 4202-1013 | N4 |
| white   | 190 x 260                        | 240 x 320                       | 50        | 11.70   | 5                   | 10.60         | 4202-1018 | N4 |
| white   | 260 x 320                        | 320 x 370                       | 50        | 18.20   | 5                   | 16.80         | 4202-1024 | N4 |
| white   | 310 x 410                        | 370 x 470                       | 60        | 30.20   | 5                   | 26.35         | 4202-1030 | N4 |
| white   | 420 x 510                        | 480 x 580                       | 60        | 57.45   | 5                   | 52.20         | 4202-1040 | N4 |
| white   | 510 x 610                        | 590 x 680                       | 70        | 81.50   | 5                   | 73.90         | 4202-1050 | N4 |
| red   | 140 x 190                        | 180 x 230                       | 40        | 7.75    | 5                   | 7.10          | 4202-2013 | N4 |
| red   | 190 x 260                        | 240 x 320                       | 50        | 11.70   | 5                   | 10.60         | 4202-2018 | N4 |
| red   | 260 x 320                        | 320 x 370                       | 50        | 18.20   | 5                   | 16.80         | 4202-2024 | N4 |
| red   | 420 x 510                        | 480 x 580                       | 60        | 57.45   | 5                   | 52.20         | 4202-2040 | N4 |
| red   | 510 x 610                        | 590 x 680                       | 70        | 81.50   | 5                   | 73.90         | 4202-2050 | N4 |
| black   | 190 x 260                        | 240 x 320                       | 50        | 11.70   | 5                   | 10.60         | 4202-3018 | N4 |
| black   | 260 x 320                        | 320 x 370                       | 50        | 18.20   | 5                   | 16.80         | 4202-3024 | N4 |

| Photographic trays, deep form with ribs on bottom  |                                  |                                 |           |               |         |                     |               |           |    |
|---|----------------------------------|---------------------------------|-----------|---------------|---------|---------------------|---------------|-----------|----|
| Colour  | Inner dimension of base L x W mm | Outer dimension of rim L x W mm | Height mm | Profile shape | Price € | Quantity scale from | Scale price € | Item no.  |    |
| white   | 310 x 410                        | 430 x 530                       | 105       | straight      | 39.05   | 5                   | 35.50         | 4206-1030 | N4 |
| white   | 420 x 510                        | 520 x 610                       | 110       | straight      | 68.80   | 5                   | 61.75         | 4206-1040 | N4 |
| white   | 510 x 610                        | 630 x 730                       | 110       | straight      | 97.20   | 5                   | 89.35         | 4206-1050 | N4 |
| red   | 310 x 410                        | 430 x 530                       | 105       | straight      | 39.05   | 5                   | 35.50         | 4206-2030 | N4 |
| red   | 420 x 510                        | 520 x 610                       | 110       | straight      | 68.80   | 5                   | 61.75         | 4206-2040 | N4 |
| black   | 420 x 510                        | 520 x 610                       | 110       | straight      | 68.80   | 5                   | 61.75         | 4206-3040 | N4 |
| black   | 510 x 610                        | 630 x 730                       | 110       | straight      | 97.20   | 5                   | 89.35         | 4206-3050 | N4 |

| Photographic trays, shallow form without ribs on bottom, profile shape rounded  |                                  |                                 |           |         |                     |               |           |    |
|--|----------------------------------|---------------------------------|-----------|---------|---------------------|---------------|-----------|----|
| Colour   | Inner dimension of base L x W mm | Outer dimension of rim L x W mm | Height mm | Price € | Quantity scale from | Scale price € | Item no.  |    |
| white  | 110 x 160                        | 150 x 200                       | 30        | 6.45    | 5                   | 5.80          | 4203-1010 | N4 |
| white  | 140 x 190                        | 180 x 230                       | 40        | 7.75    | 5                   | 7.10          | 4203-1013 | N4 |
| white  | 190 x 260                        | 240 x 320                       | 50        | 11.70   | 5                   | 10.60         | 4203-1018 | N4 |
| white  | 260 x 320                        | 320 x 370                       | 50        | 18.20   | 5                   | 16.80         | 4203-1024 | N4 |
| white  | 310 x 410                        | 370 x 470                       | 60        | 30.20   | 5                   | 26.35         | 4203-1030 | N4 |
| white  | 420 x 510                        | 480 x 580                       | 60        | 57.45   | 5                   | 52.20         | 4203-1040 | N4 |
| white  | 510 x 610                        | 590 x 680                       | 70        | 81.50   | 5                   | 73.90         | 4203-1050 | N4 |
| red  | 110 x 160                        | 150 x 200                       | 30        | 6.45    | 5                   | 5.80          | 4203-2010 | N4 |
| red  | 140 x 190                        | 180 x 230                       | 40        | 7.75    | 5                   | 7.10          | 4203-2013 | N4 |
| red  | 190 x 260                        | 240 x 320                       | 50        | 11.70   | 5                   | 10.60         | 4203-2018 | N4 |
| red  | 260 x 320                        | 320 x 370                       | 50        | 18.20   | 5                   | 16.80         | 4203-2024 | N4 |
| red  | 310 x 410                        | 370 x 470                       | 60        | 30.20   | 5                   | 26.35         | 4203-2030 | N4 |
| red  | 510 x 610                        | 590 x 680                       | 70        | 81.50   | 5                   | 73.90         | 4203-2050 | N4 |
| black  | 110 x 160                        | 150 x 200                       | 30        | 6.45    | 5                   | 5.80          | 4203-3010 | N4 |
| black  | 140 x 190                        | 180 x 230                       | 40        | 7.75    | 5                   | 7.10          | 4203-3013 | N4 |
| black  | 190 x 260                        | 240 x 320                       | 50        | 11.70   | 5                   | 10.60         | 4203-3018 | N4 |
| black  | 260 x 320                        | 320 x 370                       | 50        | 18.20   | 5                   | 16.80         | 4203-3024 | N4 |
| black  | 310 x 410                        | 370 x 470                       | 60        | 30.20   | 5                   | 26.35         | 4203-3030 | N4 |
| black  | 510 x 610                        | 590 x 680                       | 70        | 81.50   | 5                   | 73.90         | 4203-3050 | N4 |

| Photographic trays, deep form without ribs on bottom  |                                  |                                 |           |               |         |                     |               |           |    |
|--|----------------------------------|---------------------------------|-----------|---------------|---------|---------------------|---------------|-----------|----|
| Colour   | Inner dimension of base L x W mm | Outer dimension of rim L x W mm | Height mm | Profile shape | Price € | Quantity scale from | Scale price € | Item no.  |    |
| white  | 190 x 260                        | 260 x 340                       | 85        | rounded       | 17.80   | 5                   | 16.50         | 4207-1018 | N4 |
| white  | 260 x 320                        | 330 x 390                       | 100       | rounded       | 28.75   | 5                   | 26.25         | 4207-1024 | N4 |
| white  | 310 x 410                        | 430 x 530                       | 105       | straight      | 39.05   | 5                   | 35.50         | 4207-1030 | N4 |
| white  | 420 x 510                        | 520 x 610                       | 110       | straight      | 68.80   | 5                   | 61.75         | 4207-1040 | N4 |
| white  | 510 x 610                        | 630 x 730                       | 110       | straight      | 97.20   | 5                   | 89.35         | 4207-1050 | N4 |
| red  | 190 x 260                        | 260 x 340                       | 85        | rounded       | 17.80   | 5                   | 16.50         | 4207-2018 | N4 |
| red  | 260 x 320                        | 330 x 390                       | 100       | rounded       | 28.75   | 5                   | 26.25         | 4207-2024 | N4 |
| red  | 310 x 410                        | 430 x 530                       | 105       | straight      | 39.05   | 5                   | 35.50         | 4207-2030 | N4 |
| red  | 420 x 510                        | 520 x 610                       | 110       | straight      | 68.80   | 5                   | 61.75         | 4207-2040 | N4 |
| red  | 510 x 610                        | 630 x 730                       | 110       | straight      | 97.20   | 5                   | 89.35         | 4207-2050 | N4 |
| black  | 310 x 410                        | 430 x 530                       | 105       | straight      | 39.05   | 5                   | 35.50         | 4207-3030 | N4 |
| black  | 420 x 510                        | 520 x 610                       | 110       | straight      | 68.80   | 5                   | 61.75         | 4207-3040 | N4 |
| black  | 510 x 610                        | 630 x 730                       | 110       | straight      | 97.20   | 5                   | 89.35         | 4207-3050 | N4 |

## Instrument trays



Trays for various uses: in laboratories, doctors' surgeries, hospitals, pharmacies, the foodstuffs industry – wherever there is a need for clean storage of instruments, equipment, goods and precision parts.

- ▶ Melamine, white
- ▶ Tray without lid, autoclavable
- ▶ Lid available as accessory

| Instrument trays |                 |         |                     |               |              |
|------------------|-----------------|---------|---------------------|---------------|--------------|
| Capacity ml      | L x W x H mm    | Price € | Quantity scale from | Scale price € | Item no.     |
| 500              | 210 x 110 x 35  | 9.39    | 5                   | 8.55          | 4230-2050 N3 |
| 700              | 190 x 150 x 40  | 7.40    | 5                   | 6.66          | 4230-2070 N3 |
| 1000             | 290 x 160 x 35  | 10.02   | 5                   | 9.18          | 4230-2100 N3 |
| 1800             | 290 x 160 x 60  | 16.26   | 5                   | 15.00         | 4230-2180 N3 |
| 2300             | 350 x 250 x 40  | 19.51   | 5                   | 17.78         | 4230-2230 N3 |
| 5500             | 350 x 250 x 100 | 24.60   | 5                   | 22.40         | 4230-2550 N3 |

### Accessories

| Description  | Price € | Item no.     |
|--|---------|--------------|
| Lids for instrument trays 500 ml, PS crystal clear       | 6.40    | 4230-2051 N3 |
| Lids for instrument trays 700 ml, PS crystal clear       | 8.30    | 4230-2071 N3 |
| Lids for instrument trays 1000/1800 ml, PS crystal clear | 9.45    | 4230-2101 N3 |
| Lids for instrument trays 2300/5500 ml, PS crystal clear | 12.35   | 4230-2231 N3 |

## Instrument servers



Servers for various uses - wherever there is a need for clean storage of instruments, equipment, goods and precision parts.

- ▶ Melamine, white

| Instrument servers |         |                     |               |              |
|--------------------|---------|---------------------|---------------|--------------|
| L x W x H mm       | Price € | Quantity scale from | Scale price € | Item no.     |
| 190 x 150 x 17     | 5.35    | 10                  | 4.96          | 4230-3019 N3 |
| 240 x 180 x 17     | 7.15    | 10                  | 6.55          | 4230-3024 N3 |
| 268 x 208 x 17     | 9.40    | 10                  | 8.65          | 4230-3027 N3 |
| 355 x 240 x 17     | 13.80   | 10                  | 12.60         | 4230-3036 N3 |
| 428 x 288 x 17     | 23.20   | 5                   | 21.25         | 4230-3043 N3 |

## Bowls sterilisable



Particularly stable bowl, with wide holding edge, can be stacked, substances which solidify in the bowl can easily be removed.

- ▶ PP, white
- ▶ Sterilisable up to +121°C

### Bowls sterilisable

| Capacity l | Dia. mm | Height mm | Price € | Quantity scale from | Scale price € | Item no.  |    |
|------------|---------|-----------|---------|---------------------|---------------|-----------|----|
| 1          | 160     | 70        | 2.08    | 5                   | 1.90          | 4702-0008 | N3 |
| 2          | 200     | 80        | 2.91    | 5                   | 2.84          | 4702-0017 | N3 |
| 3          | 240     | 100       | 4.43    | 5                   | 3.98          | 4702-0028 | N3 |
| 4          | 280     | 120       | 6.50    | 5                   | 5.70          | 4702-0045 | N3 |
| 7          | 320     | 130       | 9.05    | 3                   | 8.20          | 4702-0065 | N3 |
| 13         | 400     | 180       | 14.10   | 3                   | 12.85         | 4702-0013 | N3 |

## Four-sided bucket



Bucket for transporting bulky goods. Saves space, sturdy, easy to carry, available with lid.

- ▶ PE, transparent
- ▶ Graduation 500 ml, up to 12 l
- ▶ With sturdy handle made of PE
- ▶ Contents right to the top 14 l

### Four-sided bucket

| Capacity l | L x W x H mm    | Price € | Quantity scale from | Scale price € | Item no.  |    |
|------------|-----------------|---------|---------------------|---------------|-----------|----|
| 14         | 280 x 280 x 290 | 23.65   | 10                  | 21.65         | 2350-0140 | N3 |

| Accessories               |         |           |
|---------------------------|---------|-----------|
| Description               | Price € | Item no.  |
| Lid for four-sided bucket | 9.40    | 2350-0141 |

## Bucket made of PP



Bucket for transporting, decanting and mixing. Safe emptying with wide spout. Sturdy handle made of PP.

- ▶ PP, transparent
- ▶ With contents scale, graduation 1000 ml
- ▶ With spout
- ▶ Sterilisable

### Bucket made of PP

| Capacity l | Dia. mm | Height mm | Price € | Quantity scale from | Scale price € | Item no.  |    |
|------------|---------|-----------|---------|---------------------|---------------|-----------|----|
| 12         | 310     | 300       | 26.70   | 10                  | 24.10         | 2306-1012 | N3 |
| 15         | 300     | 340       | 29.25   | 10                  | 26.70         | 2306-1015 | N3 |

## Laboratory bucket



Laboratory bucket for transporting, decanting and mixing. Safe emptying with wide spout. Handle made of metal.

- ▶ PE, white
- ▶ With contents scale, graduation 1000 ml
- ▶ With spout

| Laboratory bucket |         |           |         |                     |               |           |    |  |
|-------------------|---------|-----------|---------|---------------------|---------------|-----------|----|--|
| Capacity l        | Dia. mm | Height mm | Price € | Quantity scale from | Scale price € | Item no.  |    |  |
| 10                | 290     | 280       | 25.90   | 10                  | 25.20         | 2306-0010 | N3 |  |
| 15                | 320     | 340       | 38.30   | 10                  | 34.85         | 2306-0015 | N3 |  |

## Industrial bucket with metal handle



Industrial bucket for transporting, decanting and mixing. Safe emptying with wide spout. Handle made of metal.

- ▶ LLDPE, white
- ▶ With litre scale, graduation 1000 ml
- ▶ With spout

| Industrial bucket with metal handle |         |           |         |                     |               |           |    |  |
|-------------------------------------|---------|-----------|---------|---------------------|---------------|-----------|----|--|
| Capacity l                          | Dia. mm | Height mm | Price € | Quantity scale from | Scale price € | Item no.  |    |  |
| 9                                   | 280     | 250       | 9.60    | 10                  | 8.70          | 2308-0900 | N3 |  |
| 12                                  | 300     | 280       | 12.75   | 10                  | 11.45         | 2308-1200 | N3 |  |
| 17                                  | 340     | 310       | 18.50   | 10                  | 16.65         | 2308-1700 | N3 |  |



## Bucket HDPE



For transporting, decanting and mixing. Wide spout gives rapid but safe emptying. With plastic handle.

- ▶ HDPE, white or black
- ▶ With litre scale, graduation 1000 ml
- ▶ With spout
- ▶ Bucket HDPE black, not suitable for food

### Bucket HDPE

| Capacity l | Colour | Dia. mm | Height mm | Price € | Quantity scale from | Scale price € | Item no.  |    |  |
|------------|--------|---------|-----------|---------|---------------------|---------------|-----------|----|--|
| 10,5       | black  | 286     | 289       | 17.25   | 10                  | 15.55         | 2307-0010 | N3 |  |
| 10,5       | white  | 286     | 283       | 19.45   | 10                  | 17.45         | 2307-0011 | N3 |  |
| 17         | black  | 330     | 315       | 20.60   | 10                  | 18.45         | 2307-0017 | N3 |  |
| 17         | white  | 330     | 315       | 23.15   | 10                  | 20.75         | 2307-0018 | N3 |  |

## Packaging bucket



Packaging bucket for transport, packaging and storing of various materials. Suitable for the food or building material industries and non-aggressive chemicals in environmental protection, hospitals and the household. With strong handle. Quality closure on the bucket for product safety.

- ▶ PP, white
- ▶ Air-tight closure
- ▶ Complete with lid
- ▶ With advertising printing in large quantities on request

**Bulk prices**

### Packaging bucket

| Capacity l | Dia. top mm | Height with cap mm | Price € | Quantity scale from | Scale price € | Item no.  |    |  |  |
|------------|-------------|--------------------|---------|---------------------|---------------|-----------|----|--|--|
| 1          | 132         | 131                | 1.21    | 100                 | 1.09          | 2327-0001 | N3 |  |  |
| 2          | 175         | 132                | 1.90    | 80                  | 1.75          | 2327-0020 | N3 |  |  |
| 3          | 225         | 123                | 2.40    | 45                  | 2.18          | 2327-0030 | N3 |  |  |
| 5          | 225         | 194                | 3.06    | 36                  | 2.71          | 2327-0050 | N3 |  |  |
| 10         | 268         | 263                | 4.09    | 25                  | 3.74          | 2327-0010 | N3 |  |  |

# Funnels | transparent, available in many different sizes



Funnels with suspension eyelet for safe filling of containers.

- ▶ Fine sieve made of aluminium available as accessory

## General purpose funnels PP/PE

| Outer dia. mm | Outlet dia. mm | Material | Price € | Quantity scale from | Scale price € | Item no.     |  |  |  |
|---------------|----------------|----------|---------|---------------------|---------------|--------------|--|--|--|
| 40            | 5              | PP       | 0.54    | 24                  | 0.51          | 9602-0040 N3 |  |  |  |
| 60            | 8              | PE       | 0.84    | 12                  | 0.77          | 9602-0060 N3 |  |  |  |
| 80            | 11             | PE       | 0.95    | 12                  | 0.86          | 9602-0080 N3 |  |  |  |
| 100           | 10             | PP       | 1.48    | 12                  | 1.34          | 9602-0100 N3 |  |  |  |
| 120           | 13             | PP       | 1.94    | 12                  | 1.75          | 9602-0120 N3 |  |  |  |
| 140           | 16             | PE       | 2.51    | 12                  | 2.30          | 9602-0140 N3 |  |  |  |
| 160           | 18             | PE       | 3.04    | 12                  | 2.72          | 9602-0160 N3 |  |  |  |

### Accessories

| Description                | Price € | Item no.     |
|----------------------------|---------|--------------|
| Funnel stand for 2 funnels | 45.55   | 9622-0200 N4 |
| Funnel stand for 4 funnels | 121.90  | 9622-0400 N4 |

## Barrel funnels PP/PE

| Outer dia. mm | Outlet dia. mm | Material | Price € | Quantity scale from | Scale price € | Item no.     |  |  |  |
|---------------|----------------|----------|---------|---------------------|---------------|--------------|--|--|--|
| 200           | 22             | PP       | 6.75    | 6                   | 6.10          | 9602-0200 N3 |  |  |  |
| 250           | 30             | PP       | 11.65   | 6                   | 10.50         | 9602-0250 N3 |  |  |  |
| 350           | 35             | PP       | 23.55   | 5                   | 21.55         | 9602-0350 N3 |  |  |  |
| 400           | 42             | PE       | 55.65   | 5                   | 53.90         | 9602-0400 N3 |  |  |  |
| 450           | 37             | PE       | 79.10   | 5                   | 69.20         | 9602-0450 N3 |  |  |  |

### Accessories

| Description                         | Price € | Item no.     |
|-------------------------------------|---------|--------------|
| Sieve for barrel funnels 200/250 mm | 2.54    | 9602-0251 N3 |

## Powder funnels PP/PE



Powder funnel for safe filling of containers. 9606-0240 with fine sieve made of phosphor-bronze (not for use with foodstuffs).

## Funnel stand



Funnel stand with reducing attachment for safe use for different funnel sizes. Suitable for funnels of 40 mm Ø to 160 mm Ø.

- ▶ PP, white, break-resistant
- ▶ For 2 or 4 funnels
- ▶ Each with two reducer inserts
- ▶ Steplessly height adjustable



### Powder funnels PP/PE

| Outer dia. mm | Outlet dia. mm | Material | Price € | Quantity scale from | Scale price € | Item no.  |    |  |
|---------------|----------------|----------|---------|---------------------|---------------|-----------|----|--|
| 80            | 21             | PP       | 2.18    | 10                  | 1.95          | 9606-0080 | N3 |  |
| 100           | 22             | PP       | 2.27    | 10                  | 2.03          | 9606-0100 | N3 |  |
| 150           | 28             | PP       | 4.33    | 5                   | 3.89          | 9606-0150 | N3 |  |
| 253           | 50             | PE       | 10.95   | 10                  | 9.85          | 9606-0240 | N3 |  |
| 350           | 65             | PP       | 31.25   | 5                   | 30.10         | 9606-0350 | N3 |  |

### Accessories

| Description                | Price € | Item no.     |
|----------------------------|---------|--------------|
| Funnel stand for 2 funnels | 45.55   | 9622-0200 N4 |
| Funnel stand for 4 funnels | 121.90  | 9622-0400 N4 |

### Funnel stand

| Model         | L x W x H mm    | Price € | Quantity scale from | Scale price € | Item no.  |    |
|---------------|-----------------|---------|---------------------|---------------|-----------|----|
| for 2 funnels | 300 x 140 x 480 | 45.55   | 5                   | 40.25         | 9622-0200 | N4 |
| for 4 funnels | 550 x 150 x 500 | 121.90  | 5                   | 112.20        | 9622-0400 | N4 |

## Sedimentation funnel



Sedimentation funnel, Imhoff funnel.

- ▶ SAN, crystal clear
- ▶ Shatterproof
- ▶ With emptying stopper
- ▶ DIN 12672
- ▶ Graduated up to 1000 ml

### ① Sedimentation funnel

| Model          | Price € | Quantity scale from | Scale price € | Item no.     |
|----------------|---------|---------------------|---------------|--------------|
| Funnel, single | 30.75   | 3                   | 27.80         | 7118-1000 N3 |

### ② Stand for sedimentation funnel

| L x W x H mm    | Price € | Quantity scale from | Scale price € | Item no.     |
|-----------------|---------|---------------------|---------------|--------------|
| 300 x 220 x 450 | 85.20   | 3                   | 79.10         | 7118-2000 N3 |

## Safety funnel



Safety funnel for filling containers easily.  
With overflow protection.

- ▶ Made of stainless steel V2A
- ▶ Flame block
- ▶ Connector 2" fine thread NPT
- ▶ Discharge pipe  $\varnothing$  3.5 cm

### ③ Safety funnel stainless steel

| Price € | Item no.     |
|---------|--------------|
| 249.45  | 2601-9900 N2 |

## Graduated beakers with handle



- ▶ PP, transparent
- ▶ With indestructible graduation



Graduated beakers with handle, transparent graduation filled



Graduated beakers with handle, blue graduation filled

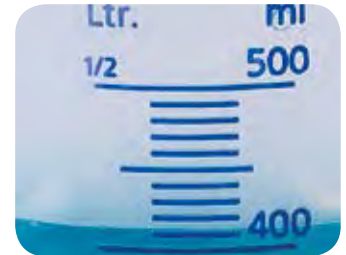

Graduated beakers made of PP are virtually indestructible and highly transparent.

Graduated beakers are perfectly suited as advertising means for chemical products. The smooth surface enables print of a logo or an advertising slogan.

### Graduated beakers with handle, blue graduation

| Capacity ml | Dia. top mm | Dia. bottom mm | Height mm | Price € | Quantity scale from | Scale price € | Item no.  |    |
|-------------|-------------|----------------|-----------|---------|---------------------|---------------|-----------|----|
| 100         | 50          | 40             | 80        | 1.58    | 24                  | 1.54          | 7104-0100 | N3 |
| 250         | 70          | 50             | 120       | 2.89    | 12                  | 2.64          | 7104-0250 | N3 |
| 500         | 91          | 75             | 133       | 3.33    | 12                  | 3.00          | 7104-0500 | N3 |
| 1000        | 116         | 95             | 170       | 4.44    | 6                   | 4.07          | 7104-1000 | N3 |
| 2000        | 150         | 125            | 215       | 8.65    | 6                   | 8.05          | 7104-2000 | N3 |
| 3000        | 170         | 120            | 242       | 11.85   | 6                   | 10.60         | 7104-3000 | N3 |
| 5000        | 210         | 160            | 270       | 17.15   | 6                   | 15.75         | 7104-5000 | N3 |

### Graduated beakers with handle, transparent graduation

| Capacity ml | Dia. top mm | Dia. bottom mm | Height mm | Price € | Quantity scale from | Scale price € | Item no.  |    |
|-------------|-------------|----------------|-----------|---------|---------------------|---------------|-----------|----|
| 100         | 50          | 40             | 80        | 1.35    | 24                  | 1.30          | 7102-0100 | N3 |
| 250         | 70          | 50             | 120       | 2.60    | 12                  | 2.38          | 7102-0250 | N3 |
| 500         | 91          | 75             | 133       | 2.89    | 12                  | 2.64          | 7102-0500 | N3 |
| 1000        | 116         | 95             | 170       | 4.19    | 6                   | 3.76          | 7102-1000 | N3 |
| 2000        | 150         | 125            | 215       | 8.65    | 6                   | 8.05          | 7102-2000 | N3 |
| 3000        | 170         | 120            | 242       | 11.85   | 6                   | 10.60         | 7102-3000 | N3 |
| 5000        | 210         | 160            | 270       | 17.15   | 6                   | 15.75         | 7102-5000 | N3 |

## Laboratory beakers/Griffin beakers, PP



Laboratory beakers according to DIN 12331 and ISO 7056 (Glass) for various uses. When bought in bulk, individual print is possible.

- ▶ PP, highly transparent
- ▶ Blue graduation printed on
- ▶ Shatterproof
- ▶ Autoclavable

### Laboratory beakers/Griffin beakers, PP

| Capacity ml | Division ml | Scaling from ml | Dia. mm | Height mm | Price € | Quantity scale from | Scale price € | Item no.  |    |
|-------------|-------------|-----------------|---------|-----------|---------|---------------------|---------------|-----------|----|
| 25          | 1           | 5               | 34      | 49        | 1.04    | 12                  | 0.97          | 7122-0025 | N3 |
| 50          | 5           | 10              | 43      | 60        | 1.14    | 12                  | 1.05          | 7122-0050 | N3 |
| 100         | 5           | 10              | 51      | 72        | 1.36    | 12                  | 1.26          | 7122-0100 | N3 |
| 150         | 5           | 10              | 58      | 82        | 1.86    | 12                  | 1.71          | 7122-0150 | N3 |
| 250         | 5           | 20              | 70      | 95        | 1.86    | 6                   | 1.71          | 7122-0250 | N3 |
| 400         | 10          | 20              | 80      | 110       | 2.68    | 6                   | 2.60          | 7122-0400 | N3 |
| 500         | 50          | 50              | 88      | 122       | 2.85    | 6                   | 2.59          | 7122-0500 | N3 |
| 600         | 25          | 50              | 93      | 125       | 2.94    | 12                  | 2.68          | 7122-0600 | N3 |
| 1000        | 50          | 100             | 108     | 148       | 4.44    | 6                   | 4.07          | 7122-1000 | N3 |
| 2000        | 100         | 200             | 140     | 188       | 8.25    | 6                   | 7.50          | 7122-2000 | N3 |
| 3000        | 200         | 500             | 174     | 214       | 16.10   | 4                   | 14.70         | 7122-3000 | N3 |
| 5000        | 500         | 500             | 185     | 248       | 20.95   | 4                   | 19.00         | 7122-5000 | N3 |

## Graduated beakers, stackable



Graduated beaker with graduation printed in blue, open handle, conical. Beakers can be stacked and therefore save space during storage.

- ▶ PP, transparent
- ▶ Sterilisable
- ▶ Shatterproof
- ▶ Good chemical resistance

### Graduated beakers, stackable

| Capacity ml | Division ml | Height mm | Dia. top mm | Price € | Quantity scale from | Scale price € | Item no.  |    |
|-------------|-------------|-----------|-------------|---------|---------------------|---------------|-----------|----|
| 1000        | 10          | 167       | 125         | 4.44    | 12                  | 4.07          | 7110-1000 | N3 |
| 2000        | 20          | 212       | 148         | 8.65    | 12                  | 7.90          | 7110-2000 | N3 |

## Advertise with your good name

Many articles in this catalog are outstandingly suitable for carrying your advertisements. No matter whether as a promotional gift or as a supplement to your own product: your name is always present.

### Printing subjects

Company logos, instructions for use, advertising messages, table of contents, scales – we set no limits to your fantasies or wishes.

### Colors

We can print in all the usual color scales such as RAL, Pantone, HKS or to your color sample.

### Printing area

The area that can be printed depends on the particular product. We will be pleased to advise you.

### Resistance

The printing is resistant to weak acids and alkalis, and to most solvents. It is very resistant to both mechanical damage and light. Your advertising message will not fade even after many years of use.

### From artwork to print

1. You send us your copy or artwork – we can process virtually any data format.
2. On request we can also support you with your a layout.
3. After a few days you will receive a proof sheet for your acceptance.
4. In our works your advertising message will be permanently applied in topquality.

### Costs

We treat each print job individually. As each print job is different, we always make a separate offer for each inquiry. The total cost is made up of the price of the product, preliminary costs (finalizing the artwork and making the screen) and printing costs.

### Printable products

- ▶ Graduated beakers (page 211)
- ▶ Graduated cylinders (page 214)
- ▶ Pressure atomiser (page 170)
- ▶ Measuring scoops (page 139)
- ▶ Bottles (page 156)
- ▶ Flow indicators (page 236)



## Graduated cylinders, tall form



Measuring cylinder, tall shape, according to DIN 12 680(Glass)/ISO 6706, with hexagonal base. For use in laboratories, chemists, in workshops, during outdoor field work and wherever volumetric measurements have to be made during production.

## Graduated cylinders, tall-form, made of SAN



- ▶ SAN, crystal clear
- ▶ Category B (DIN 12681 / ISO 6706)
- ▶ Embossed graduation with rings at the main points
- ▶ Adjusted to "In"

### Graduated cylinders, tall-form, made of SAN

| Capacity ml | Division ml | Outer dia. mm | Stand dia. mm | Height mm | Price € | Quantity scale from | Scale price € | Item no.  |    |
|-------------|-------------|---------------|---------------|-----------|---------|---------------------|---------------|-----------|----|
| 100         | 1           | 34            | 65            | 260       | 7.20    | 12                  | 6.55          | 7506-0100 | N3 |
| 500         | 5           | 61            | 95            | 350       | 15.25   | 6                   | 13.75         | 7506-0500 | N3 |
| 1000        | 10          | 76            | 125           | 415       | 18.35   | 6                   | 16.85         | 7506-1000 | N3 |



## Graduated cylinders, PP







- ▶ PP, highly transparent
- ▶ Category B (DIN 12681 / ISO 6706)
- ▶ Embossed blue graduation with rings at the main points
- ▶ Shatterproof at room temperature
- ▶ Adjusted to "In"





## Graduated cylinders, PP



- ▶ PP, highly transparent
- ▶ Category B (DIN 12681 / ISO 6706)
- ▶ Embossed transparent graduation with rings at the main points
- ▶ Shatterproof at room temperature
- ▶ Adjusted to "In"

Graduated cylinders, PP, tall-form, blue graduation    

| Capacity ml | Division ml | Outer dia. mm | Stand dia. mm | Height mm | Price € | Quantity scale from | Scale price € | Item no.     |
|-------------|-------------|---------------|---------------|-----------|---------|---------------------|---------------|--------------|
| 50          | 1           | 27            | 55            | 200       | 4.96    | 12                  | 4.57          | 7503-0050 N3 |
| 100         | 1           | 33            | 65            | 250       | 6.45    | 12                  | 5.80          | 7503-0100 N3 |
| 250         | 2           | 44            | 75            | 315       | 9.95    | 6                   | 9.15          | 7503-0250 N3 |
| 500         | 5           | 58            | 95            | 360       | 13.25   | 6                   | 12.05         | 7503-0500 N3 |
| 1000        | 10          | 69            | 125           | 440       | 17.95   | 6                   | 16.35         | 7503-1000 N3 |
| 2000        | 20          | 97            | 160           | 482       | 32.30   | 3                   | 29.40         | 7503-2000 N3 |

Graduated cylinders, PP, tall-form, embossed graduation    

| Capacity ml | Division ml | Outer dia. mm | Stand dia. mm | Height mm | Price € | Quantity scale from | Scale price € | Item no.     |
|-------------|-------------|---------------|---------------|-----------|---------|---------------------|---------------|--------------|
| 50          | 1           | 27            | 55            | 200       | 2.75    | 12                  | 2.49          | 7502-0050 N3 |
| 100         | 1           | 33            | 65            | 250       | 3.59    | 12                  | 3.14          | 7502-0100 N3 |
| 250         | 2           | 44            | 75            | 315       | 5.85    | 6                   | 5.35          | 7502-0250 N3 |
| 500         | 5           | 58            | 95            | 360       | 8.05    | 6                   | 7.30          | 7502-0500 N3 |
| 1000        | 10          | 69            | 125           | 440       | 10.95   | 6                   | 9.85          | 7502-1000 N3 |
| 2000        | 20          | 97            | 160           | 482       | 24.75   | 3                   | 22.45         | 7502-2000 N3 |

# Measuring jugs industrial



Light and handy polypropylene measuring jug is suitable for industrial applications. The measuring jug has two measuring scales, embossed transparent and with blue lettering. With ergonomic handle, available in closed design for special stability or with open handle for stacking to save space. The measuring jug is made of polypropylene and is therefore highly resistant to acids, bases and chemicals.

## Measuring jug industrial, with closed handle

| Capacity ml | Dia. mm | Height mm | Division ml | Price € | Quantity scale from | Scale price € | Item no.  |    |  |
|-------------|---------|-----------|-------------|---------|---------------------|---------------|-----------|----|--|
| 500         | 90      | 135       | 10          | 2.82    | 16                  | 2.54          | 7204-0500 | N3 |  |
| 1000        | 117     | 165       | 10          | 3.79    | 12                  | 3.42          | 7204-1000 | N3 |  |
| 2000        | 151     | 206       | 20          | 7.10    | 12                  | 6.40          | 7204-2000 | N3 |  |
| 3000        | 175     | 238       | 50          | 9.25    | 10                  | 8.30          | 7204-3000 | N3 |  |
| 5000        | 203     | 257       | 100         | 12.90   | 5                   | 11.60         | 7204-5000 | N3 |  |

- ▶ PP transparent
- ▶ With embossed graduation printed in blue

Please inquire about special prices for large quantities!

## Measuring jug industrial, stacking

| Capacity ml | Dia. mm | Height mm | Division ml | Price € | Quantity scale from | Scale price € | Item no.  |    |  |
|-------------|---------|-----------|-------------|---------|---------------------|---------------|-----------|----|--|
| 500         | 90      | 135       | 10          | 2.82    | 16                  | 2.54          | 7210-0500 | N3 |  |
| 1000        | 117     | 165       | 10          | 3.79    | 12                  | 3.42          | 7210-1000 | N3 |  |
| 2000        | 151     | 206       | 20          | 7.10    | 12                  | 6.40          | 7210-2000 | N3 |  |
| 3000        | 175     | 238       | 50          | 9.25    | 10                  | 8.30          | 7210-3000 | N3 |  |
| 5000        | 203     | 257       | 100         | 12.90   | 5                   | 11.60         | 7210-5000 | N3 |  |

**Bulk prices**

# Universal graduated beakers



Universal graduated beakers with indestructible graduation. The three specially formed spouts enable easy pouring of liquids. Due to great pricing, they can also be used as disposable graduated beakers.

- ▶ PP, transparent, autoclavable
- ▶ Space-saving stacking in one another

**!** Attention! Make sure to pay attention to the "List of Chemical Resistance"!

**\* Bulk prices**



Universal graduated beakers

| Capacity ml | Dia. bottom mm | Dia. top mm | Division ml | Price € | Quantity scale from | Scale price € | Item no.     |
|-------------|----------------|-------------|-------------|---------|---------------------|---------------|--------------|
| 50          | 31             | 45          | 5           | 0.36    | 100                 | 0.33          | 7109-0050 N3 |
| 100         | 38             | 55          | 10          | 0.44    | 100                 | 0.38          | 7109-0100 N3 |
| 250         | 48             | 75          | 10          | 0.80    | 100                 | 0.76          | 7109-0250 N3 |
| 400         | 51             | 83          | 20          | 1.01    | 100                 | 0.94          | 7109-0400 N3 |
| 1000        | 72             | 113         | 50          | 1.70    | 100                 | 1.54          | 7109-1000 N3 |



## Titration burette automatic



Burette with Schellbach stripes type Schilling / Bürkle with original Bürkle dosing armature.

A universal aid in the laboratory, electroplating industry, water treatment plants, for field analyses, etc.

Precise dosing using the press button, exact fine titration with the micro-screw and precise discharge jet.

Graduation according to Category B (Tolerances according to DIN EN ISO 385).

- ▶ Adjusted for Ex
- ▶ Burette made of borosilicate glass 3.3
- ▶ Resistant to chemicals
- ▶ Blue ring graduations (Colordur)
- ▶ Left or right hand operation possible
- ▶ Sturdy stand
- ▶ Precise discharge jet, allowing very fine drops
- ▶ Parts in contact with the medium: PE, PP, natural rubber, borosilicate glass

Attention! Make sure to pay attention to the "List of Chemical Resistance"!

Titration burette automatic

| Burette capacity ml | Division ml | Precision ml | Height cm | Capacity l | Price € | Quantity scale from | Scale price € | Item no.     |
|---------------------|-------------|--------------|-----------|------------|---------|---------------------|---------------|--------------|
| 5                   | 0.05        | ± 0,03       | 61        | 0.5        | 44.65   | 10                  | 40.15         | 9695-1005 N4 |
| 10                  | 0.05        | ± 0,03       | 56        | 0.5        | 44.65   | 10                  | 40.15         | 9695-1010 N4 |
| 15                  | 0.1         | ± 0,045      | 52        | 0.5        | 44.65   | 10                  | 40.15         | 9695-1015 N4 |
| 25                  | 0.1         | ± 0,045      | 65        | 1          | 44.65   | 10                  | 40.15         | 9695-1025 N4 |
| 50                  | 0.1         | ± 0,075      | 92        | 1          | 52.10   | 10                  | 46.90         | 9695-1050 N4 |

## Splinter-proof titrating burette

The titrating burette with splinter protection is a fast acting burette with Schellbach stripes based on Dr. Schilling's design with automatic zero point extraction and Bürkle dosing armature.

The glass burette has a plastic sheathing which increases resistance to breaking and protects against splinters. The possibility of the burette breaking is much lower than with a conventional burette, and if it does break, there will be no dangerous splinters.

The Bürkle dosing armature allows for precise dosing and exact fine titration with the press button or micro-screw and precise discharge through the discharge jet.

- ▶ Burette with splinter-proof sheathing
- ▶ Adjusted to Ex
- ▶ Burette made of borosilicate glass 3.3
- ▶ Shatter-proof, resistant to chemicals
- ▶ Sturdy stand
- ▶ Precise discharge jet, allowing very fine drops
- ▶ Parts in contact with medium: PE, PP, natural rubber, borosilicate glass



Splinter-proof titrating burette



| Burette capacity ml | Division ml | Precision ml | Height cm | Capacity l | Price € | Quantity scale from | Scale price € | Item no.     |
|---------------------|-------------|--------------|-----------|------------|---------|---------------------|---------------|--------------|
| 15                  | 0.1         | ± 0,045      | 52        | 0,5        | 56.65   | 10                  | 52.15         | 9695-3015 N4 |
| 25                  | 0.1         | ± 0,045      | 65        | 1          | 56.65   | 10                  | 52.15         | 9695-3025 N4 |
| 50                  | 0.1         | ± 0,075      | 92        | 1          | 64.10   | 10                  | 58.90         | 9695-3050 N4 |

## Single-use pipettes

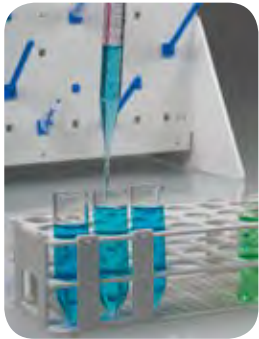

- ▶ Polystyrene, crystal clear
- ▶ Individually sterile-packed
- ▶ For aqueous solutions

## Disposable pipettes LDPE



- ▶ LDPE
- ▶ Dropping pipette, not graduated

### Single-use pipettes PS

| Capacity ml | Price € | Quantity scale from | Scale price € | Item no.     |
|-------------|---------|---------------------|---------------|--------------|
| 25          | 1.90    | 100                 | 1.55          | 7556-0025 N3 |
| 50          | 4.05    | 50                  | 3.23          | 7556-0050 N3 |
| 100         | 17.90   | 20                  | 14.95         | 7556-0100 N3 |



### Disposable pipettes LDPE

| Capacity ml | Length mm | Pieces per pack | Price € | Quantity scale from | Scale price € | Item no.     |
|-------------|-----------|-----------------|---------|---------------------|---------------|--------------|
| 1,8         | 98        | 100             | 18.85   | 10                  | 17.00         | 7555-0001 N4 |
| 1,7         | 145       | 100             | 18.85   | 10                  | 17.00         | 7555-0002 N4 |
| 2,4         | 155       | 100             | 18.85   | 10                  | 17.00         | 7555-0003 N4 |



## Graduated pipettes



- ▶ PP, transparent
- ▶ Blue, permanently coloured graduation and labelling

### Graduated pipettes

| Capacity ml | Price € | Quantity scale from | Scale price € | Item no.  |    |  |
|-------------|---------|---------------------|---------------|-----------|----|--|
| 10          | 8.80    | 12                  | 8.05          | 7550-0010 | N3 |  |

## Single mark pipettes



- ▶ PP, transparent
- ▶ Blue, permanently coloured graduation and labelling

### Single mark pipettes

| Capacity ml | Price € | Quantity scale from | Scale price € | Item no.  |    |  |
|-------------|---------|---------------------|---------------|-----------|----|--|
| 10          | 13.65   | 10                  | 13.20         | 7553-0010 | N3 |  |
| 25          | 14.25   | 12                  | 13.55         | 7553-0025 | N3 |  |
| 50          | 14.45   | 12                  | 13.85         | 7553-0050 | N3 |  |

## Pi-Pump | safety pipette controller



Suction via handwheel. If the handwheel is stopped, the piston remains in place and no liquid flows out



Discharge via outlet lever. Very small quantities can be removed with great accuracy by turning the handwheel

Proven thousands of time, fits naturally into the hand. The handwheel ensures precise suction. The contents can be purged by pressing back the piston. Dispensing with the lateral switch.

- ▶ Easy to use, precise
- ▶ Available in three sizes (colour-coded)

### Pi-Pump

| Fits for pipette up to ... ml | Colour | Price € | Quantity scale from | Scale price € | Item no.     |
|-------------------------------|--------|---------|---------------------|---------------|--------------|
| 2                             | blue   | 12.05   | 10                  | 10.95         | 7551-0002 N3 |
| 10                            | green  | 12.05   | 5                   | 10.95         | 7551-0010 N3 |
| 25                            | red    | 13.25   | 5                   | 11.95         | 7551-0025 N3 |

## Safety pipetting-ball

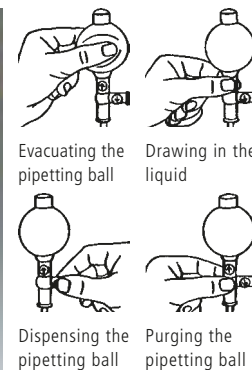

Peleus ball, simple pipetting aid. Evacuation takes place via an automatic valve. By pressing the valves, the liquid is drawn up, dispensed or purged. The removable automatic valve also enables effective cleaning of the inside.

- ▶ For all pipettes up to 100 ml
- ▶ Available in various colours

### Safety pipetting-ball

| Colour | Price € | Quantity scale from | Scale price € | Item no.     |
|--------|---------|---------------------|---------------|--------------|
| red    | 14.20   | 10                  | 13.35         | 7554-0002 N3 |
| yellow | 14.20   | 10                  | 13.35         | 7554-0004 N3 |
| blue   | 14.20   | 10                  | 13.35         | 7554-0005 N3 |
| green  | 14.20   | 10                  | 13.35         | 7554-0006 N3 |



## Pipette stand | rotatable



Pipette stand for 94 pipettes of different sizes. Base-plate with raised edge which catches dripping liquid. The delicate pipette tips are placed in a rotatable base-plate with conical grooves.

- ▶ PP
- ▶ Sterilisable up to 121°C

| ① Pipette stand |                     |               |              |
|-----------------|---------------------|---------------|--------------|
| Price €         | Quantity scale from | Scale price € | Item no.     |
| 49.00           | 3                   | 45.05         | 9630-0090 N3 |

## Pipette rinsing system



### ② Pipette rinsing system

For easy and gentle cleaning and safe storage of pipettes. A complete system suitable for every lab.

- ▶ PE transparent
- ▶ Effective height 600 mm

### ③ Pipette basket

The basket is an accessory for the pipette rinser.

### ② Pipette rinsing system

| Capacity l | Inner dia. mm | Stand dia. mm | Height mm | Price € | Quantity scale from | Scale price € | Item no.     |
|------------|---------------|---------------|-----------|---------|---------------------|---------------|--------------|
| 17         | 165           | 315           | 740       | 181.55  | 5                   | 164.35        | 9650-0650 N3 |

### ③ Pipette basket

| Capacity l | Stand dia. mm | Height mm | Price € | Quantity scale from | Scale price € | Item no.     |
|------------|---------------|-----------|---------|---------------------|---------------|--------------|
| 17         | 145           | 280       | 35.35   | 4                   | 32.15         | 9650-0653 N3 |

### ④ Cleaning and storage container for pipettes

| Capacity l | Inner dia. mm | Outer dia. mm | Stand dia. mm | Height mm | Price € | Quantity scale from | Scale price € | Item no.     |
|------------|---------------|---------------|---------------|-----------|---------|---------------------|---------------|--------------|
| 10         | 155           | 165           | 240           | 550       | 82.80   | 5                   | 75.35         | 9650-0651 N3 |
| 12,5       | 155           | 165           | 240           | 660       | 81.65   | 5                   | 72.85         | 9650-0652 N3 |

## Draining rack, wallmount | practical, hygienic, attractive shape

Draining rack made of plastic, shatterproof, proven thousands of times in the lab and adjusted to the requirements there.

The stable rods are individually placed into the holes of the draining rack and are clicked into place. Their positions can be changed at any time. Using a combination of rods of three different lengths (60 mm, 100 mm and extension to 150 mm), the draining rack can be adapted to any apparatus which is to be dried.

Available in three different sizes:

- ▶ **Draining rack 40x40 cm** with rods 60 mm (5x), 100 mm (26x) and extension 150 mm (2x)
- ▶ **Draining rack 50x50 cm** with rods 60 mm (10x), 100 mm (39x) and extension 150 mm (4x)
- ▶ **Draining rack 60x60 cm** with rods 60 mm (15x), 100 mm (56x) and extension 150 mm (6x)

Extension Item No. 9640-0415 can only be used with rod Item No. 9640-0410.

Available as:

- ▶ Draining rack, wallmount, incl. wall mounting set (screws, dowels), optionally available with removable draining channel which has a connection for a draining tube (The drainage water goes into the lab basin)
- ▶ Draining rack, benchtop, with collecting pan
- ▶ Draining rack PVC, rods PP
- ▶ Incl. spanner for the rods

Attention! Make sure to pay attention to the "List of Chemical Resistance"!



### Draining rack, wallmount

| Model                    | W x H mm  | Price € | Quantity<br>scale from | Scale<br>price € | Item no.     |
|--------------------------|-----------|---------|------------------------|------------------|--------------|
| without draining channel | 400 x 400 | 141.20  | 3                      | 129.05           | 9640-1040 N4 |
| without draining channel | 500 x 500 | 167.65  | 3                      | 154.35           | 9640-1050 N4 |
| without draining channel | 600 x 600 | 194.25  | 3                      | 174.85           | 9640-1060 N4 |
| with draining channel    | 400 x 400 | 162.85  | 3                      | 150.75           | 9640-2040 N4 |
| with draining channel    | 500 x 500 | 194.25  | 3                      | 174.85           | 9640-2050 N4 |
| with draining channel    | 600 x 600 | 221.90  | 3                      | 202.65           | 9640-2060 N4 |

### Accessories

| Description  | Price € | Item no.     |
|--|---------|--------------|
| Rods for draining rack length 60 mm, dia. 6 mm             | 1.03    | 9640-0421 N4 |
| Rods for draining rack length 100 mm, dia. 10 mm           | 1.03    | 9640-0410 N4 |
| Extension rods for draining rack length 150 mm, dia. 12 mm | 1.39    | 9640-0415 N4 |

## Draining rack, benchtop

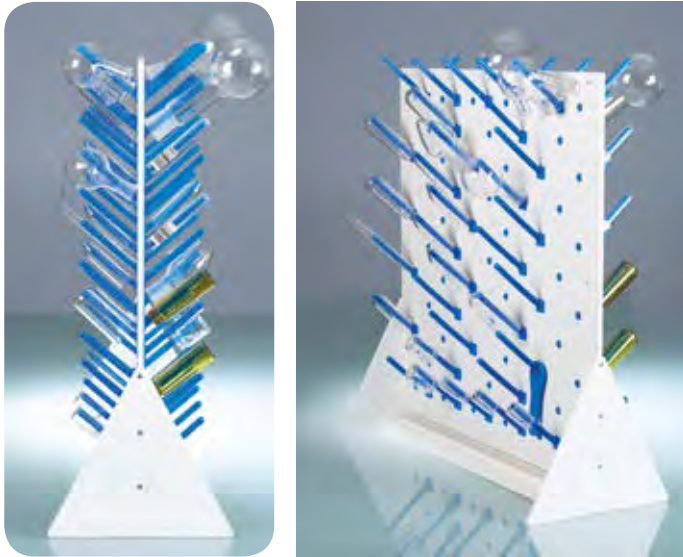

The draining rack is easy and flexible to set down on a table or working surface. Two large supports with wide bases ensure sufficient stability. Since both sides of the draining board can be used, it provides twice the hanging space. The collecting pan can simply be removed for emptying.

- ▶ Flexible, can be used on both sides



### Draining rack, benchtop

| W x H mm  | Price € | Quantity scale from | Scale price € | Item no.  |    |
|-----------|---------|---------------------|---------------|-----------|----|
| 400 x 400 | 162.85  | 3                   | 150.75        | 9640-3040 | N4 |
| 500 x 500 | 194.25  | 3                   | 174.85        | 9640-3050 | N4 |
| 600 x 600 | 221.90  | 3                   | 202.65        | 9640-3060 | N4 |

### Accessories

| Description  | Price € | Item no.     |
|--|---------|--------------|
| Rods for draining rack length 60 mm, dia. 6 mm             | 1.03    | 9640-0421 N4 |
| Rods for draining rack length 100 mm, dia. 10 mm           | 1.03    | 9640-0410 N4 |
| Extension rods for draining rack length 150 mm, dia. 12 mm | 1.39    | 9640-0415 N4 |

## Test-tube racks



Universal test tube rack with retention system. Allows all test tubes to be emptied simultaneously. Suitable for test tubes in most standard diameters. Alphanumerically marked positions for specific identification of samples. Test tube rack with 24 storing positions without retention system.

- ▶ PP, coloured, shatterproof
- ▶ Steam sterilisable up to +121°C
- ▶ Dimensions: 246 x 104 x 64 mm

### Test-tube racks

| For tubes up to ... dia. mm | Colour | No. of tubes | Price € | Quantity scale from | Scale price € | Item no.  |    |
|-----------------------------|--------|--------------|---------|---------------------|---------------|-----------|----|
| 16                          | white  | 60           | 10.70   | 5                   | 10.15         | 9635-0021 | N3 |
| 20                          | white  | 40           | 10.70   | 5                   | 10.15         | 9635-0031 | N3 |
| 20                          | red    | 40           | 10.70   | 5                   | 10.15         | 9635-0032 | N3 |
| 20                          | blue   | 40           | 10.70   | 5                   | 10.15         | 9635-0035 | N3 |
| 25                          | white  | 24           | 13.00   | 5                   | 12.25         | 9635-0041 | N3 |

## SnowPack® dry ice machine | - 79 °C cryogenic cooling on-tap



SnowPack® enables you to obtain a - 79 °C dry ice tablet weighing 50 or 250 g within a few moments, without complicated technology and without electricity! You can therefore obtain low-cost cooling to very low temperatures at any time you like.

SnowPack® is often used in hospitals, universities, schools, institutes, laboratories, in the chemical industry and in materials testing facilities.

Examples of use: Lowering the temperature in cooling baths or cold traps, pre-cooling tissue samples, ensuring safe transport or embedding biological substances, freezing blood and tissue samples, studies in chemistry, physics and materials technology, etc. Dry ice is easy to handle, odourless and flavourless. The SnowPack® dry ice machine can be installed on any commercial CO<sub>2</sub>-bottle with a standpipe (without pressure regu-

lator) (thread W 21.80 x 1/14" according to DIN 477-1 No. 6). These often exist in many production facilities and laboratories anyway. If this is not the case, a bottle can be rented for a small price from a local specialist gas distributor.

### The use of SnowPack® is easy:

1. Simply screw SnowPack® onto a CO<sub>2</sub> bottle with standpipe.
2. Open the valve, CO<sub>2</sub> gas flows into the SnowPack® and crystallises to dry ice.
3. Open the clamp.
4. Take out the dry ice pellet.

- ▶ Ideal cooling media for sample transport
- ▶ Performance depends on room temperature and pressure



### SnowPack® dry ice machine

| Model         | Tablet dia. x H mm | Weight g | Gas escape time ca. min | Tablets per 22 kg bottle | Price € | Item no.     |
|---------------|--------------------|----------|-------------------------|--------------------------|---------|--------------|
| SnowPack® 50  | 50 x 30            | 50       | 0,5                     | approx. 90               | 194.85  | 9805-0030 N4 |
| SnowPack® 250 | 80 x 60            | 250      | 1                       | approx. 16               | 239.45  | 9805-0200 N4 |

## PVC pressure tubing



Fabric reinforced, permanent transparency, increased flexibility, high chemical resistance, excellent ageing and abrasion resistance, environmentally friendly, cadmium-free. Foodstuffs quality according to the EC Guideline 1935/2004.

- ▶ Clear
- ▶ Hardness Shore A 70 ± 3
- ▶ Operating temperature -20°C to +60°C
- ▶ TÜV-approved (German industry standards)

**!** The pressure figures are maximum values (bursting pressure) under optimum ambient conditions. The user is responsible for determining any suitability!

| PVC pressure tubing |               |               |                   |                   |         |           |    |  |
|---------------------|---------------|---------------|-------------------|-------------------|---------|-----------|----|--|
| Inner dia. mm       | Roll length m | Outer dia. mm | Wall thickness mm | Pressure max. bar | Price € | Item no.  |    |  |
| 6                   | 10            | 12            | 3                 | 20                | 16.65   | 8802-0612 | N3 |  |
| 6                   | 50            | 12            | 3                 | 20                | 44.80   | 8876-0612 | N3 |  |
| 8                   | 10            | 14            | 3                 | 18                | 19.25   | 8802-0814 | N3 |  |
| 8                   | 50            | 14            | 3                 | 18                | 54.20   | 8876-0814 | N3 |  |
| 9                   | 10            | 15            | 3                 | 16                | 20.55   | 8802-0915 | N3 |  |
| 9                   | 50            | 15            | 3                 | 16                | 59.20   | 8876-0915 | N3 |  |
| 10                  | 10            | 16            | 3                 | 14                | 22.10   | 8802-1016 | N3 |  |
| 10                  | 50            | 16            | 3                 | 14                | 65.55   | 8876-1016 | N3 |  |
| 12                  | 10            | 18            | 3                 | 14                | 26.95   | 8802-1218 | N3 |  |
| 12                  | 50            | 18            | 3                 | 14                | 85.20   | 8876-1218 | N3 |  |
| 13,2                | 10            | 20            | 3,3               | 12                | 28.95   | 8802-1320 | N3 |  |
| 13,2                | 50            | 20            | 3,3               | 12                | 98.85   | 8876-1320 | N3 |  |

### Accessories

| Description | Price € | Item no.     |
|-------------|---------|--------------|
| Hose cutter | 7.50    | 0006-9506 N3 |

## PVC industrial tubing



Hose made of soft PVC, cadmium-free, with high resistance to chemicals, high flexibility and permanent crystal clear transparency and excellent abrasion resistance. Foodstuffs quality according to the EC Guideline 1935/2004.

- ▶ Clear
- ▶ Hardness Shore A 80 ± 3
- ▶ Operating temperature -20°C to +50°C
- ▶ For pressureless operation

| PVC industrial tubing |               |               |                   |         |           |    |  |  |
|-----------------------|---------------|---------------|-------------------|---------|-----------|----|--|--|
| Inner dia. mm         | Roll length m | Outer dia. mm | Wall thickness mm | Price € | Item no.  |    |  |  |
| 2                     | 10            | 4             | 1                 | 5.10    | 8801-0204 | N3 |  |  |
| 2                     | 100           | 4             | 1                 | 11.65   | 8875-0204 | N3 |  |  |
| 3                     | 10            | 5             | 1                 | 6.20    | 8801-0305 | N3 |  |  |
| 3                     | 100           | 5             | 1                 | 15.85   | 8875-0305 | N3 |  |  |
| 4                     | 10            | 6             | 1                 | 7.40    | 8801-0406 | N3 |  |  |
| 4                     | 100           | 6             | 1                 | 18.15   | 8875-0406 | N3 |  |  |
| 5                     | 10            | 7             | 1                 | 8.05    | 8801-0507 | N3 |  |  |
| 5                     | 100           | 7             | 1                 | 21.80   | 8875-0507 | N3 |  |  |
| 6                     | 10            | 8             | 1                 | 8.65    | 8801-0608 | N3 |  |  |
| 6                     | 100           | 8             | 1                 | 26.00   | 8875-0608 | N3 |  |  |
| 7                     | 10            | 10            | 1,5               | 11.95   | 8801-0710 | N3 |  |  |
| 7                     | 100           | 10            | 1,5               | 46.70   | 8875-0710 | N3 |  |  |
| 8                     | 10            | 11            | 1,5               | 12.25   | 8801-0811 | N3 |  |  |
| 8                     | 50            | 11            | 1,5               | 26.55   | 8875-0811 | N3 |  |  |
| 9                     | 10            | 12            | 1,5               | 12.45   | 8801-0912 | N3 |  |  |
| 9                     | 50            | 12            | 1,5               | 27.30   | 8875-0912 | N3 |  |  |
| 10                    | 10            | 13            | 1,5               | 13.75   | 8801-1013 | N3 |  |  |
| 10                    | 50            | 13            | 1,5               | 31.50   | 8875-1013 | N3 |  |  |
| 12                    | 10            | 16            | 2                 | 18.45   | 8801-1216 | N3 |  |  |
| 12                    | 50            | 16            | 2                 | 47.75   | 8875-1216 | N3 |  |  |
| 13                    | 10            | 19            | 3                 | 25.65   | 8801-1319 | N3 |  |  |
| 13                    | 50            | 19            | 3                 | 79.10   | 8875-1319 | N3 |  |  |
| 19                    | 10            | 25            | 3                 | 33.30   | 8801-1925 | N3 |  |  |
| 19                    | 50            | 25            | 3                 | 107.50  | 8875-1925 | N3 |  |  |

### Accessories

| Description | Price € | Item no.     |
|-------------|---------|--------------|
| Hose cutter | 7.50    | 0006-9506 N3 |

## PTFE tubing



Excellent properties: Extremely high chemical resistance against nearly all chemicals, smallest frictional coefficient, excellent anti-adhesive qualities/residue emptying. PTFE hoses do not emit odours, do not burn or smoke and are resistant to ageing and UV light. Not resistant to fluorine compounds or strong reducing agents.

- ▶ Transparent
- ▶ Hardness Shore D 55
- ▶ Temperature -200°C to +260 °C
- ▶ Autoclavable, ethylene oxide
- ▶ Flavour and odour neutral

The pressure figures are maximum values (bursting pressure) under optimum ambient conditions. The user is responsible for determining any suitability!

| PTFE tubing   |               |               |                   |                   |         |           |    |  |  |  |
|---------------|---------------|---------------|-------------------|-------------------|---------|-----------|----|--|--|--|
| Inner dia. mm | Roll length m | Outer dia. mm | Wall thickness mm | Pressure max. bar | Price € | Item no.  |    |  |  |  |
| 1             | 5             | 3             | 1                 | 240               | 17.40   | 8804-0103 | N3 |  |  |  |
| 1             | 50            | 3             | 1                 | 240               | 108.30  | 8879-0103 | N3 |  |  |  |
| 2             | 5             | 4             | 1                 | 120               | 22.35   | 8804-0204 | N3 |  |  |  |
| 2             | 50            | 4             | 1                 | 120               | 146.75  | 8879-0204 | N3 |  |  |  |
| 3             | 5             | 5             | 1                 | 80                | 28.25   | 8804-0305 | N3 |  |  |  |
| 3             | 50            | 5             | 1                 | 80                | 200.30  | 8879-0305 | N3 |  |  |  |
| 4             | 5             | 6             | 1                 | 60                | 31.35   | 8804-0406 | N3 |  |  |  |
| 4             | 50            | 6             | 1                 | 60                | 223.55  | 8879-0406 | N3 |  |  |  |
| 6             | 5             | 8             | 1                 | 40                | 40.35   | 8804-0608 | N3 |  |  |  |
| 6             | 50            | 8             | 1                 | 40                | 281.45  | 8879-0608 | N3 |  |  |  |
| 8             | 5             | 10            | 1                 | 30                | 53.15   | 8804-0810 | N3 |  |  |  |
| 8             | 50            | 10            | 1                 | 30                | 379.10  | 8879-0810 | N3 |  |  |  |
| 10            | 5             | 12            | 1                 | 20                | 65.55   | 8804-1012 | N3 |  |  |  |
| 10            | 50            | 12            | 1                 | 20                | 459.40  | 8879-1012 | N3 |  |  |  |

**Accessories**

| Description | Price € | Item no.     |
|-------------|---------|--------------|
| Hose cutter | 7.50    | 0006-9506 N3 |

## PE tubing



The PE hose is recognised as safe physiologically, resistant against (non-oxidizing) acids, caustic solutions, salts and a number of solvents, pressure resistant, flexible, impact resistant, light, resistant to compression, up to + 80 °C deformation resistant.

- ▶ Transparent
- ▶ Hardness Shore A 80 ± 3
- ▶ Temperature -40°C to +95°C
- ▶ Suitable for food

The pressure figures are maximum values (bursting pressure) under optimum ambient conditions. The user is responsible for determining any suitability!

| PE tubing     |               |               |                   |                   |         |           |    |  |
|---------------|---------------|---------------|-------------------|-------------------|---------|-----------|----|--|
| Inner dia. mm | Roll length m | Outer dia. mm | Wall thickness mm | Pressure max. bar | Price € | Item no.  |    |  |
| 3             | 10            | 5             | 1                 | 13                | 8.80    | 8805-0305 | N3 |  |
| 3             | 100           | 5             | 1                 | 13                | 26.49   | 8878-0305 | N3 |  |
| 4             | 10            | 6             | 1                 | 10                | 9.70    | 8805-0406 | N3 |  |
| 4             | 100           | 6             | 1                 | 10                | 35.35   | 8878-0406 | N3 |  |
| 6             | 10            | 8             | 1                 | 7                 | 14.30   | 8805-0608 | N3 |  |
| 6             | 100           | 8             | 1                 | 7                 | 46.00   | 8878-0608 | N3 |  |
| 10            | 10            | 14            | 2                 | 8                 | 28.65   | 8805-1014 | N3 |  |
| 10            | 100           | 14            | 2                 | 8                 | 171.04  | 8878-1014 | N3 |  |
| 12            | 10            | 16            | 2                 | 7                 | 33.00   | 8805-1216 | N3 |  |

**Accessories**

| Description | Price € | Item no.     |
|-------------|---------|--------------|
| Hose cutter | 7.50    | 0006-9506 N3 |

## Silicone tubing



Very flexible, transparent hose. Good resistance against weak acids and alkalis. Do not use for strong acids and caustic solutions. Swells in organic solvents. Largely nonreactive to ionising solvents except chlorinated aliphatic and aromatic hydrocarbons.

- ▶ Transparent
- ▶ Hardness Shore A 55 ± 5
- ▶ Temperature -60°C up to +180°C
- ▶ Autoclavable, ethylene oxide
- ▶ Suitable for food

| Silicone tubing |               |               |                   |         | autoclavable<br>121° | ISO 15 | ISO 15 |
|-----------------|---------------|---------------|-------------------|---------|----------------------|--------|--------|
| Inner dia. mm   | Roll length m | Outer dia. mm | Wall thickness mm | Price € | Item no.             |        |        |
| 3               | 10            | 5             | 1                 | 19.10   | 8803-0305 N3         |        |        |
| 3               | 50            | 5             | 1                 | 52.05   | 8881-0305 N3         |        |        |
| 4               | 10            | 6             | 1                 | 20.55   | 8803-0406 N3         |        |        |
| 4               | 50            | 6             | 1                 | 61.70   | 8881-0406 N3         |        |        |
| 5               | 10            | 8             | 1,5               | 31.90   | 8803-0508 N3         |        |        |
| 5               | 50            | 8             | 1,5               | 105.00  | 8881-0508 N3         |        |        |
| 6               | 10            | 9             | 1,5               | 36.30   | 8803-0609 N3         |        |        |
| 6               | 50            | 9             | 1,5               | 121.90  | 8881-0609 N3         |        |        |
| 7               | 10            | 10            | 1,5               | 40.65   | 8803-0710 N3         |        |        |
| 7               | 50            | 10            | 1,5               | 135.10  | 8881-0710 N3         |        |        |
| 8               | 10            | 12            | 2                 | 53.95   | 8803-0812 N3         |        |        |
| 8               | 50            | 12            | 2                 | 185.65  | 8881-0812 N3         |        |        |
| 10              | 5             | 15            | 2,5               | 42.90   | 8803-1015 N3         |        |        |
| 10              | 50            | 15            | 2,5               | 285.90  | 8881-1015 N3         |        |        |
| 12              | 5             | 16            | 2                 | 39.25   | 8803-1216 N3         |        |        |
| 12              | 25            | 16            | 2                 | 130.30  | 8881-1216 N3         |        |        |

### Accessories

| Description | Price € | Item no.     |
|-------------|---------|--------------|
| Hose cutter | 7.50    | 0006-9506 N3 |

## Hose cutter



Edges cut with the hose cutter are always clean and flat, even in the case of thick hoses.

### Hose cutter

| Price € | Quantity scale from | Scale price € | Item no.     |
|---------|---------------------|---------------|--------------|
| 7.50    | 10                  | 6.85          | 0006-9506 N3 |

## Make connections – with Bürkle LaboPlast® hose connectors



Bürkle offers a large portfolio of different hose connectors that are used to extend, connect, branch, join and repair hoses, etc.

The ranges of application are diverse and thus the requirements for shape, size and material properties are broadly based.



We produce our LaboPlast® hose connectors in many sizes and shapes (I, T, Y, X, L) to be able to also safeguard a flexible and safe solution and connection for demanding applications at all times.



We offer these connectors made of polypropylene as standard. However here we would like to point out our connectors made of PVDF (polyvinylidene fluoride).



Do you prefer moving images of our connectors?  
– No problem! Visit us at

[www.buerkle.de/videos](http://www.buerkle.de/videos)

or simply scan the code opposite with your smartphone and select the films that you find interesting.

## PVDF – for demanding applications

PVDF is a fluoropolymer with superior product properties:

- ▶ Highest chemical resistance
- ▶ High temperature resistance (up to 160 °C)
- ▶ Food industry approval
- ▶ Autoclavable
- ▶ UV-resistant

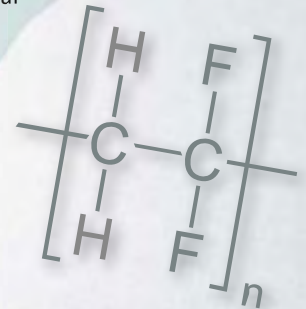

If you value high-quality and flexible solutions for demanding applications, test our unique connector made of PVDF.

**Improve your connections –  
with Bürkle LaboPlast® PVDF hose connectors!**





## Y-connectors

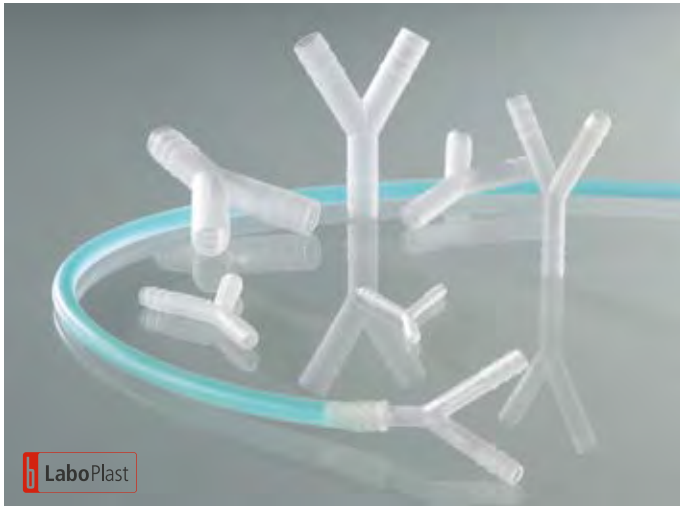

Cylindrical Y hose connector to connect hoses.

- ▶ PP, Temperature resistant up to +135°C max.
- ▶ PVDF, Temperature resistant up to +160°C max., highly resistant to chemicals
- ▶ Sterilisable

| Y-connectors |             |                 |         |                     |               |           |    |  |  |  |
|--------------|-------------|-----------------|---------|---------------------|---------------|-----------|----|--|--|--|
| Material     | For dia. mm | Pieces per pack | Price € | Quantity scale from | Scale price € | Item no.  |    |  |  |  |
| PP           | 3-5         | 10              | 7.00    | 20                  | 6.20          | 8706-0004 | N4 |  |  |  |
| PP           | 5-7         | 10              | 8.05    | 20                  | 7.30          | 8706-0006 | N4 |  |  |  |
| PP           | 6-8         | 10              | 10.20   | 20                  | 9.35          | 8706-0007 | N4 |  |  |  |
| PP           | 7-9         | 10              | 10.20   | 20                  | 9.35          | 8706-0008 | N4 |  |  |  |
| PP           | 9-11        | 10              | 11.65   | 20                  | 10.60         | 8706-0010 | N4 |  |  |  |
| PP           | 11-13       | 10              | 13.35   | 10                  | 12.05         | 8706-0012 | N4 |  |  |  |
| PP           | 13-15       | 10              | 15.45   | 10                  | 14.05         | 8706-0014 | N4 |  |  |  |
|              |             |                 |         |                     |               |           |    |  |  |  |
| PVDF         | 3-5         | 10              | 9.90    | 20                  | 8.85          | 8712-0004 | N4 |  |  |  |
| PVDF         | 5-7         | 10              | 11.10   | 20                  | 10.10         | 8712-0006 | N4 |  |  |  |
| PVDF         | 7-9         | 10              | 14.15   | 20                  | 12.80         | 8712-0008 | N4 |  |  |  |
| PVDF         | 9-11        | 10              | 16.25   | 20                  | 14.70         | 8712-0010 | N4 |  |  |  |
| PVDF         | 11-13       | 10              | 18.55   | 20                  | 16.70         | 8712-0012 | N4 |  |  |  |
| PVDF         | 13-15       | 10              | 21.35   | 10                  | 19.25         | 8712-0014 | N4 |  |  |  |

## T-connectors

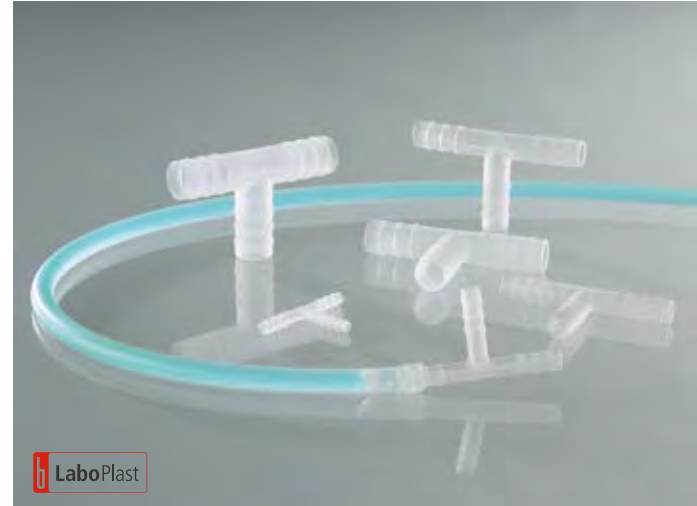

Cylindrical T hose connector to connect hoses.

- ▶ PP, Temperature resistant up to +135°C max.
- ▶ PVDF, Temperature resistant up to +160°C max., highly resistant to chemicals
- ▶ Sterilisable

| T-connectors |             |                 |         |                     |               |           |    |  |  |  |
|--------------|-------------|-----------------|---------|---------------------|---------------|-----------|----|--|--|--|
| Material     | For dia. mm | Pieces per pack | Price € | Quantity scale from | Scale price € | Item no.  |    |  |  |  |
| PP           | 3-5         | 10              | 4.83    | 20                  | 4.39          | 8705-0004 | N4 |  |  |  |
| PP           | 5-7         | 10              | 6.00    | 20                  | 5.00          | 8705-0006 | N4 |  |  |  |
| PP           | 7-9         | 10              | 7.00    | 20                  | 6.20          | 8705-0008 | N4 |  |  |  |
| PP           | 9-11        | 10              | 8.05    | 20                  | 7.30          | 8705-0010 | N4 |  |  |  |
| PP           | 11-13       | 10              | 9.35    | 20                  | 8.15          | 8705-0012 | N4 |  |  |  |
| PP           | 13-15       | 10              | 10.80   | 20                  | 9.80          | 8705-0014 | N4 |  |  |  |
|              |             |                 |         |                     |               |           |    |  |  |  |
| PVDF         | 3-5         | 10              | 6.70    | 20                  | 6.10          | 8711-0004 | N4 |  |  |  |
| PVDF         | 5-7         | 10              | 8.15    | 20                  | 7.40          | 8711-0006 | N4 |  |  |  |
| PVDF         | 7-9         | 10              | 9.80    | 20                  | 8.85          | 8711-0008 | N4 |  |  |  |
| PVDF         | 9-11        | 10              | 11.10   | 20                  | 10.10         | 8711-0010 | N4 |  |  |  |
| PVDF         | 11-13       | 10              | 12.55   | 20                  | 11.30         | 8711-0012 | N4 |  |  |  |
| PVDF         | 13 - 15     | 10              | 14.80   | 20                  | 13.25         | 8711-0014 | N4 |  |  |  |

## Angled connectors



Cylindrical angle hose connector to connect hoses.

- ▶ PP, Temperature resistant up to +135°C max.
- ▶ PVDF, Temperature resistant up to +160°C max., highly resistant to chemicals
- ▶ Sterilisable

| Angled connectors |             |                 |         |                     |               |           |    |  |  |  |
|-------------------|-------------|-----------------|---------|---------------------|---------------|-----------|----|--|--|--|
| Material          | For dia. mm | Pieces per pack | Price € | Quantity scale from | Scale price € | Item no.  |    |  |  |  |
| PP                | 3-5         | 10              | 3.84    | 20                  | 3.50          | 8707-0004 | N4 |  |  |  |
| PP                | 5-7         | 10              | 4.28    | 20                  | 3.84          | 8707-0006 | N4 |  |  |  |
| PP                | 7-9         | 10              | 4.51    | 20                  | 4.07          | 8707-0008 | N4 |  |  |  |
| PP                | 9-11        | 10              | 5.30    | 20                  | 4.83          | 8707-0010 | N4 |  |  |  |
| PP                | 11-13       | 10              | 6.35    | 20                  | 5.80          | 8707-0012 | N4 |  |  |  |
| PP                | 13-15       | 10              | 7.60    | 20                  | 6.85          | 8707-0014 | N4 |  |  |  |
|                   |             |                 |         |                     |               |           |    |  |  |  |
| PVDF              | 3-5         | 10              | 5.56    | 20                  | 5.07          | 8713-0004 | N4 |  |  |  |
| PVDF              | 5-7         | 10              | 6.08    | 20                  | 5.56          | 8713-0006 | N4 |  |  |  |
| PVDF              | 7-9         | 10              | 6.40    | 20                  | 5.82          | 8713-0008 | N4 |  |  |  |
| PVDF              | 9-11        | 10              | 7.66    | 20                  | 7.03          | 8713-0010 | N4 |  |  |  |
| PVDF              | 11-13       | 10              | 9.18    | 10                  | 8.18          | 8713-0012 | N4 |  |  |  |
| PVDF              | 13-15       | 10              | 11.28   | 20                  | 10.18         | 8713-0014 | N4 |  |  |  |

## Four-way-connectors



Cylindrical four-way hose connector to connect hoses.

- ▶ PP, Temperature resistant up to +135°C max.
- ▶ PVDF, Temperature resistant up to +160°C max., highly resistant to chemicals
- ▶ Sterilisable

| Four-way-connectors |             |                 |         |                     |               |           |    |  |  |  |
|---------------------|-------------|-----------------|---------|---------------------|---------------|-----------|----|--|--|--|
| Material            | For dia. mm | Pieces per pack | Price € | Quantity scale from | Scale price € | Item no.  |    |  |  |  |
| PP                  | 3-5         | 10              | 7.00    | 10                  | 6.20          | 8708-0004 | N4 |  |  |  |
| PP                  | 5-7         | 10              | 8.05    | 10                  | 7.30          | 8708-0006 | N4 |  |  |  |
| PP                  | 7-9         | 10              | 10.20   | 10                  | 9.35          | 8708-0008 | N4 |  |  |  |
| PP                  | 9-11        | 10              | 11.65   | 10                  | 10.60         | 8708-0010 | N4 |  |  |  |
| PP                  | 11-13       | 10              | 13.35   | 10                  | 12.05         | 8708-0012 | N4 |  |  |  |
| PP                  | 13-15       | 10              | 15.45   | 10                  | 14.05         | 8708-0014 | N4 |  |  |  |
|                     |             |                 |         |                     |               |           |    |  |  |  |
| PVDF                | 3-5         | 10              | 9.90    | 10                  | 8.85          | 8717-0004 | N4 |  |  |  |
| PVDF                | 5-7         | 10              | 11.10   | 10                  | 10.10         | 8717-0006 | N4 |  |  |  |
| PVDF                | 7-9         | 10              | 14.15   | 10                  | 12.80         | 8717-0008 | N4 |  |  |  |
| PVDF                | 9-11        | 10              | 16.25   | 10                  | 14.70         | 8717-0010 | N4 |  |  |  |
| PVDF                | 11-13       | 10              | 18.55   | 10                  | 16.70         | 8717-0012 | N4 |  |  |  |
| PVDF                | 13-15       | 10              | 21.35   | 10                  | 19.25         | 8717-0014 | N4 |  |  |  |

## Hose tubing connectors, straight



Cylindrical straight hose connectors for various hose sizes.

- ▶ PP, Temperature resistant up to +135°C max.
- ▶ PVDF, Temperature resistant up to +160°C max., highly resistant to chemicals
- ▶ Sterilisable

| Hose tubing connectors, straight, cylindrical nozzles |             |                 |         |                     |               |           |    |  |  |  |
|---|-------------|-----------------|---------|---------------------|---------------|-----------|----|--|--|--|
| Material  | For dia. mm | Pieces per pack | Price € | Quantity scale from | Scale price € | Item no.  |    |  |  |  |
| PP  | 3-5         | 10              | 3.34    | 20                  | 3.13          | 8701-0004 | N4 |  |  |  |
| PP  | 5-7         | 10              | 4.28    | 20                  | 3.84          | 8701-0006 | N4 |  |  |  |
| PP  | 7-9         | 10              | 4.83    | 20                  | 4.39          | 8701-0008 | N4 |  |  |  |
| PP  | 9-11        | 10              | 5.45    | 20                  | 4.89          | 8701-0010 | N4 |  |  |  |
| PP  | 11-13       | 10              | 6.20    | 20                  | 5.70          | 8701-0012 | N4 |  |  |  |
| PP  | 13-15       | 10              | 7.10    | 20                  | 6.45          | 8701-0014 | N4 |  |  |  |
|   |             |                 |         |                     |               |           |    |  |  |  |
| PVDF  | 3-5         | 10              | 4.73    | 20                  | 4.13          | 8710-0004 | N4 |  |  |  |
| PVDF  | 5-7         | 10              | 5.82    | 20                  | 5.30          | 8710-0006 | N4 |  |  |  |
| PVDF  | 7-9         | 10              | 6.77    | 20                  | 6.08          | 8710-0008 | N4 |  |  |  |
| PVDF  | 9-11        | 10              | 7.55    | 20                  | 6.77          | 8710-0010 | N4 |  |  |  |
| PVDF  | 11-13       | 10              | 8.55    | 20                  | 7.76          | 8710-0012 | N4 |  |  |  |
| PVDF  | 13-15       | 10              | 10.28   | 20                  | 9.07          | 8710-0014 | N4 |  |  |  |

## Universal hose tubing connectors

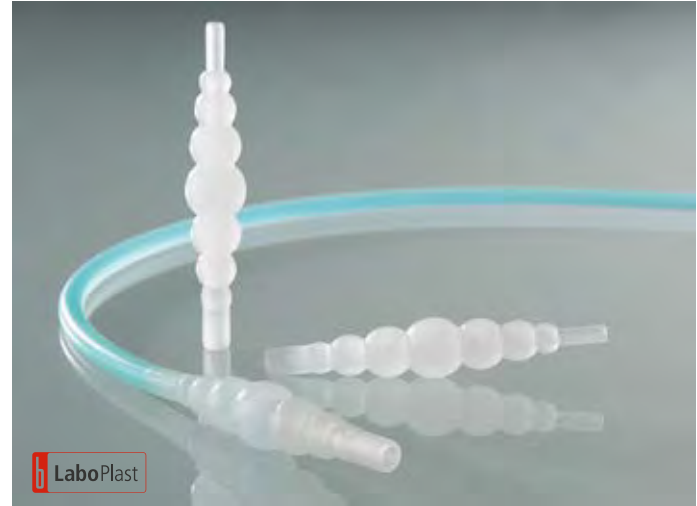

Conical, straight hose connectors for universal use.

- ▶ PP, Temperature resistant up to +135°C max.
- ▶ PVDF, Temperature resistant up to +160°C max., highly resistant to chemicals
- ▶ Sterilisable

| Universal hose tubing connectors with conical nozzles |             |                 |         |                     |               |           |    |  |  |  |
|---|-------------|-----------------|---------|---------------------|---------------|-----------|----|--|--|--|
| Material  | For dia. mm | Pieces per pack | Price € | Quantity scale from | Scale price € | Item no.  |    |  |  |  |
| PP  | 4-17        | 10              | 16.55   | 10                  | 15.00         | 8700-0417 | N4 |  |  |  |
| PVDF  | 4-17        | 10              | 23.75   | 20                  | 21.55         | 8710-0417 | N4 |  |  |  |

## Hose tubing connectors



Conical, straight hose connectors for various hose sizes.

- ▶ PP
- ▶ Sterilisable

### Hose tubing connectors

| For dia. mm | Pieces per pack | Price € | Quantity scale from | Scale price € | Item no.  |    |
|-------------|-----------------|---------|---------------------|---------------|-----------|----|
| 3-5         | 10              | 5.90    | 10                  | 5.30          | 8700-0406 | N3 |
| 5-7         | 10              | 6.35    | 10                  | 5.85          | 8700-0608 | N3 |
| 7-10        | 10              | 7.80    | 10                  | 7.00          | 8700-0810 | N3 |
| 9-12        | 10              | 9.10    | 10                  | 8.40          | 8700-1012 | N3 |
| 11-14       | 10              | 11.00   | 10                  | 9.95          | 8700-1214 | N3 |
| 13-15       | 10              | 12.40   | 10                  | 11.45         | 8700-1416 | N3 |

## Reducing hose connectors



Reducing nozzles for the reduction from big-ger to small hoses.

- ▶ PP
- ▶ Sterilisable

### Reducing hose connectors

| For dia. mm    | Pieces per pack | Price € | Quantity scale from | Scale price € | Item no.  |    |
|----------------|-----------------|---------|---------------------|---------------|-----------|----|
| 4-8/<br>8-12   | 10              | 12.30   | 10                  | 11.50         | 8703-0408 | N3 |
| 4-8/<br>12-16  | 10              | 13.55   | 10                  | 12.60         | 8703-0412 | N3 |
| 8-12/<br>12-16 | 10              | 15.25   | 10                  | 13.55         | 8703-0812 | N3 |

## Hose couplings



Attachable, conical hose couplings for pres-sureless operation.

- ▶ PE

### Hose couplings

| For dia. mm | Pieces per pack | Price € | Quantity scale from | Scale price € | Item no.  |    |
|-------------|-----------------|---------|---------------------|---------------|-----------|----|
| 3-5         | 10              | 11.25   | 10                  | 10.25         | 8704-0406 | N3 |
| 5-7         | 10              | 12.15   | 10                  | 11.25         | 8704-0608 | N3 |
| 7-10        | 10              | 14.75   | 10                  | 13.00         | 8704-0810 | N3 |
| 9-12        | 10              | 15.75   | 10                  | 14.30         | 8704-1012 | N3 |
| 11-14       | 10              | 18.25   | 10                  | 16.60         | 8704-1214 | N3 |
| 13-16       | 10              | 19.80   | 10                  | 18.00         | 8704-1416 | N3 |

## Non-return valves



Retaining valve with embossed directional arrow or printed in black. With conical nozzles. Various uses.

- ▶ Resistant to compression max. 4 bar
- ▶ Operating temperature +0 to +40 °C
- ▶ With PP valve ball, on request also with ball made of stainless steel or PTFE



### Non-return valves with conical inlet/outlet

| For dia. mm | Print    | Price € | Quantity scale from | Scale price € | Item no.     |
|-------------|----------|---------|---------------------|---------------|--------------|
| ① 6-8       | embossed | 2.45    | 100                 | 2.23          | 8714-0060 N4 |
| ① 8-10      | embossed | 2.45    | 100                 | 2.23          | 8714-0080 N4 |
| ① 10-14     | embossed | 3.06    | 100                 | 2.42          | 8714-0100 N4 |
| ② 6-8       | black    | 2.68    | 100                 | 2.46          | 8714-1006 N4 |
| ② 8-10      | black    | 2.68    | 50                  | 2.46          | 8714-1008 N4 |
| ② 10-14     | black    | 3.29    | 100                 | 2.65          | 8714-1010 N4 |

## Magic Box



In this magic box, you can invariably find the appropriate hose connector you are looking for. Magic box includes 68 connectors: **Two of each** in sizes **4, 6, 8, 10, 12** and **14 mm**

- ▶ Straight hose connector Item No. 8701-
- ▶ T hose connector Item No. 8705-
- ▶ Y hose connector Item No. 8706-
- ▶ X hose connector Item No. 8708-
- ▶ Angle hose connector Item No. 8707-

**Two of each** for hoses from **4-17 mm**

- ▶ Universal hose connector Item No. 8700-0417

**Two of each** in sizes **4-8, 4-12, and 8-12 mm**

- ▶ Reducing hose connector Item No. 8703-
- ▶ PP, shatterproof and transparent

### Magic Box

| Price € | Quantity scale from | Scale price € | Item no.     |
|---------|---------------------|---------------|--------------|
| 56.20   | 5                   | 50.40         | 8715-1000 N4 |

## Flow indicators

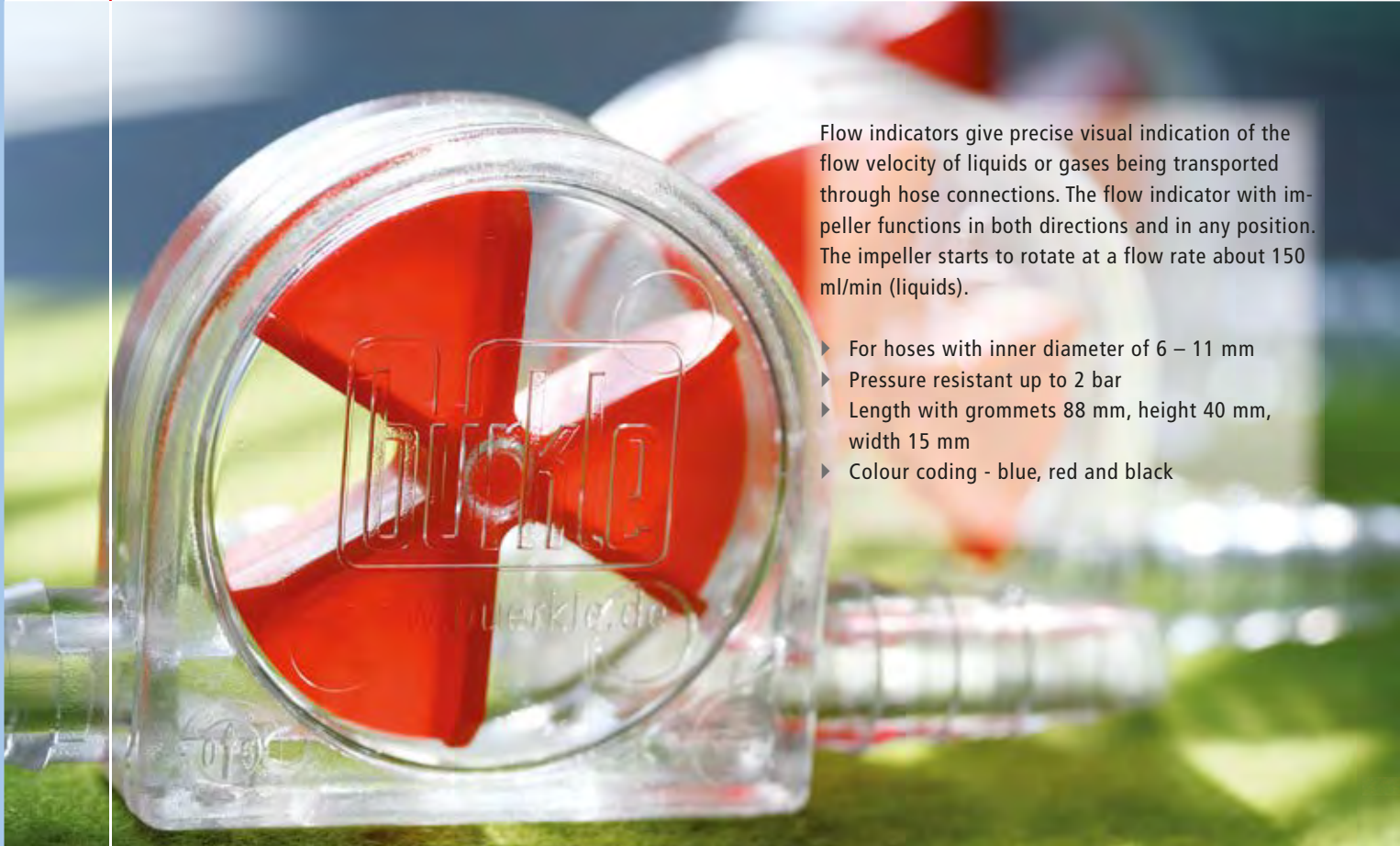

Flow indicators give precise visual indication of the flow velocity of liquids or gases being transported through hose connections. The flow indicator with impeller functions in both directions and in any position. The impeller starts to rotate at a flow rate about 150 ml/min (liquids).

- ▶ For hoses with inner diameter of 6 – 11 mm
- ▶ Pressure resistant up to 2 bar
- ▶ Length with grommets 88 mm, height 40 mm, width 15 mm
- ▶ Colour coding - blue, red and black



## Flow indicators LiquiMobil SAN



LiquiMobil flow indicator made of SAN is mainly suitable for cooling systems and helps to reduce water consumption considerably because the cooling water flow can be adjusted better. Not suitable for aggressive substances.

- ▶ Operating temperature LiquiMobil SAN max. +30°C

### Flow indicators LiquiMobil SAN

| Colour | Price € | Quantity scale from | Scale price € | Item no.  |  |  |
|--------|---------|---------------------|---------------|-----------|---|---|
| red    | 9.65    | 10                  | 8.85          | 8720-1002 | N4  |   |
| black  | 9.65    | 10                  | 8.85          | 8720-1003 | N4  |   |
| blue   | 9.65    | 10                  | 8.85          | 8720-1005 | N4  |   |



## Flow indicators CheMobil PMP



CheMobil made of PMP/TPX can be used for many substances due to its good chemical resistance. Not suitable for strong acids, alkalis and solvents. CheMobil can be steam sterilised.

- ▶ Operating temperature CheMobil PMP max. +60°C

### Flow indicators CheMobil PMP

| Colour | Price € | Quantity scale from | Scale price € | Item no.  |  |  |  |
|--------|---------|---------------------|---------------|-----------|---|---|---|
| red    | 11.90   | 10                  | 10.50         | 8720-2002 | N4  |   |   |
| black  | 11.90   | 10                  | 10.50         | 8720-2003 | N4  |   |   |
| blue   | 11.90   | 10                  | 10.50         | 8720-2005 | N4  |   |   |

## stop-it hose clamps



The hose clip can be used wherever the flow in hoses with liquids or gases needs to be regulated or stopped.

Stepless flow regulation: With the hose clip stop-it's knurled screw, a stepless, delicate flow regulation or complete stop of the flow are possible, even for existing hose connections. The hose is compressed over a wide area against the sturdy steel hook in order to prevent it from being damaged.





## stop-it with Easy-Click closure



Easy-Click closure - stop-it can be opened and closed in any position - without tiresome screwing on and off. High quality material - stop-it made from the heat resistant and chemical resistant plastic PVDF. The clamp is galvanised steel.

- ▶ PVDF, aluminium and steel, zinc coated
- ▶ Temperature resistant up to 140 °C
- ▶ For flexible hoses with outer Ø up to 10 mm, 15 mm and 20 mm
- ▶ Available in four fresh colours

## stop-it metal



The materials steel and aluminium ensure that the stop-it metal is extremely heat resistant and sturdy. The hose clip is available in four different sizes, for hose diameters up to max. 30 mm.

- ▶ Galvanised steel and aluminium
- ▶ For flexible hoses with outer Ø up to 10 mm, 15 mm 20 mm and 30 mm

**Bulk prices**

### stop-it with Easy-Click closure

| For dia. mm | Colour | Price € | Quantity scale from | Scale price € | Item no.  |    |
|-------------|--------|---------|---------------------|---------------|-----------|----|
| to 10       | red    | 2.10    | 50                  | 1.89          | 8619-0102 | N4 |
| to 10       | yellow | 2.10    | 50                  | 1.89          | 8619-0104 | N4 |
| to 10       | blue   | 2.10    | 50                  | 1.89          | 8619-0105 | N4 |
| to 10       | green  | 2.10    | 50                  | 1.89          | 8619-0106 | N4 |
| to 15       | red    | 3.50    | 50                  | 3.27          | 8619-0152 | N4 |
| to 15       | yellow | 3.50    | 50                  | 3.27          | 8619-0154 | N4 |
| to 15       | blue   | 3.50    | 50                  | 3.27          | 8619-0155 | N4 |
| to 15       | green  | 3.50    | 50                  | 3.27          | 8619-0156 | N4 |
| to 20       | red    | 4.42    | 50                  | 4.03          | 8619-0202 | N4 |
| to 20       | yellow | 4.42    | 50                  | 4.03          | 8619-0204 | N4 |
| to 20       | blue   | 4.42    | 50                  | 4.03          | 8619-0205 | N4 |
| to 20       | green  | 4.42    | 50                  | 4.03          | 8619-0206 | N4 |

### stop-it metal

| For dia. mm | Price € | Quantity scale from | Scale price € | Item no.  |    |  |
|-------------|---------|---------------------|---------------|-----------|----|--|
| up to 10    | 2.64    | 50                  | 2.40          | 8619-0510 | N4 |  |
| up to 15    | 4.22    | 50                  | 3.76          | 8619-0515 | N4 |  |
| up to 20    | 4.59    | 50                  | 4.08          | 8619-0520 | N4 |  |
| up to 30    | 7.00    | 50                  | 6.25          | 8619-0530 | N4 |  |

## Hose clamp Squeeze-Fix



The hose can be squeezed in phases or completely compressed, as required.

- ▶ Can be operated with one hand
- ▶ POM (white, sterilisable, does not rust, permanently elastic, hygienic)

### Hose clamp Squeeze-Fix

| For dia. mm | Length mm | Price € | Quantity scale from | Scale price € | Item no.  |    |
|-------------|-----------|---------|---------------------|---------------|-----------|----|
| 1-5         | 25        | 0.54    | 100                 | 0.46          | 8618-0001 | N3 |
| 3-10        | 40        | 1.38    | 100                 | 1.21          | 8618-0002 | N3 |
| 6-15        | 55        | 2.03    | 100                 | 1.84          | 8618-0003 | N3 |

## Hose clips POM



Hose clips made of Polyacetal (POM).

### Hose clips POM

| For dia. mm | Pieces per pack | Price € | Quantity scale from | Scale price € | Item no.  |    |
|-------------|-----------------|---------|---------------------|---------------|-----------|----|
| 6 - 6,5     | 10              | 3.02    | 10                  | 2.78          | 8678-0006 | N3 |
| 9 - 10      | 10              | 2.93    | 10                  | 2.68          | 8678-0010 | N3 |
| 10 - 11     | 10              | 2.93    | 10                  | 2.68          | 8678-0011 | N3 |
| 11 - 12     | 10              | 2.93    | 10                  | 2.68          | 8678-0012 | N3 |
| 12 - 14     | 10              | 2.93    | 10                  | 2.68          | 8678-0014 | N3 |
| 13 - 15     | 10              | 2.93    | 10                  | 2.68          | 8678-0015 | N3 |
| 15 - 17     | 10              | 2.93    | 10                  | 2.68          | 8678-0017 | N3 |
| 17 - 19     | 10              | 2.93    | 10                  | 2.68          | 8678-0019 | N3 |
| 18 - 20     | 10              | 3.67    | 10                  | 3.42          | 8678-0020 | N3 |
| 20 - 22     | 10              | 3.67    | 10                  | 3.42          | 8678-0022 | N3 |
| 23 - 25     | 10              | 3.67    | 10                  | 3.42          | 8678-0025 | N3 |

## Worm-threaded hose clips



Hose clip sleeve made of stainless steel 1.4016, screw zinc coated, with screw thread.

### Worm-threaded hose clips stainless steel

| For dia. mm | Pieces per pack | Price € | Quantity scale from | Scale price € | Item no.  |    |
|-------------|-----------------|---------|---------------------|---------------|-----------|----|
| 8-12        | 10              | 9.85    | 10                  | 8.95          | 8677-0812 | N3 |
| 10-16       | 10              | 9.95    | 10                  | 9.05          | 8677-1016 | N3 |
| 12-20       | 10              | 11.50   | 10                  | 10.50         | 8677-1220 | N3 |
| 16-27       | 10              | 11.75   | 10                  | 10.60         | 8677-1625 | N3 |
| 20-32       | 10              | 11.85   | 10                  | 10.80         | 8677-2032 | N3 |
| 25-40       | 10              | 12.15   | 10                  | 11.15         | 8677-2540 | N3 |

## Two-way valves



Two and three-way valves are used for transfer of liquids or gases in order to release the flow, to block it or to change its direction.

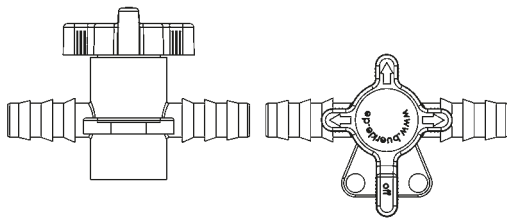

### Two-way valves

| Material | For dia. mm | Nominal width mm | Price € | Quantity scale from | Scale price € | Item no.     |  |  |  |
|----------|-------------|------------------|---------|---------------------|---------------|--------------|--|--|--|
| PP/PE    | 5-7         | 4                | 5.90    | 50                  | 5.25          | 8605-0060 N4 |  |  |  |
| PP/PE    | 7-9         | 6                | 6.80    | 50                  | 6.20          | 8605-0080 N4 |  |  |  |
| PP/PE    | 9-11        | 8                | 7.80    | 50                  | 7.00          | 8605-0100 N4 |  |  |  |
| PP/PE    | 11-13       | 8                | 7.80    | 50                  | 7.10          | 8605-0120 N4 |  |  |  |
| PVDF     | 5-7         | 4                | 9.80    | 50                  | 8.90          | 8607-0060 N4 |  |  |  |
| PVDF     | 7-9         | 6                | 11.60   | 50                  | 10.50         | 8607-0080 N4 |  |  |  |
| PVDF     | 9-11        | 8                | 13.60   | 50                  | 12.00         | 8607-0100 N4 |  |  |  |
| PVDF     | 11-13       | 8                | 13.30   | 50                  | 12.10         | 8607-0120 N4 |  |  |  |

## Three-way valves



- ▶ PVDF: excellent chemical resistance, transparent, suitable for food
- ▶ PP/PE: for industrial use, red/white
- ▶ Operating temperature: PVDF +0 up to +40 °C, PP/PE +5 up to +40 °C
- ▶ Resistant to compression max. 1 bar
- ▶ With mounting plate for easy installation

### Three-way valves

| Material | For dia. mm | Nominal width mm | Price € | Quantity scale from | Scale price € | Item no.     |  |  |  |
|----------|-------------|------------------|---------|---------------------|---------------|--------------|--|--|--|
| PP/PE    | 5-7         | 4                | 9.80    | 50                  | 8.90          | 8606-0060 N4 |  |  |  |
| PP/PE    | 7-9         | 6                | 11.60   | 50                  | 10.50         | 8606-0080 N4 |  |  |  |
| PP/PE    | 9-11        | 8                | 13.55   | 50                  | 12.00         | 8606-0100 N4 |  |  |  |
| PP/PE    | 11-13       | 8                | 13.30   | 50                  | 12.10         | 8606-0120 N4 |  |  |  |
| PVDF     | 5-7         | 4                | 15.30   | 50                  | 13.90         | 8608-0060 N4 |  |  |  |
| PVDF     | 7-9         | 6                | 17.25   | 50                  | 15.45         | 8608-0080 N4 |  |  |  |
| PVDF     | 9-11        | 8                | 19.00   | 50                  | 17.25         | 8608-0100 N4 |  |  |  |
| PVDF     | 11-13       | 8                | 18.60   | 50                  | 17.05         | 8608-0120 N4 |  |  |  |

## Valves made of PTFE, two-way/three way



Two-way / three-way valves made of solid PTFE with hose nozzles. Resistant to chemicals. Very easy connection thanks to its excellent antifriction properties. Blue handles made of PP.

- ▶ Resistant to compression max. 1 bar
- ▶ Vacuum suitable up to  $10^{-1}$  mmHg
- ▶ Autoclavable

### Valves made of PTFE, two-way and three way

| Model           | For dia. mm | Nominal width mm | Price € | Quantity scale from | Scale price € | Item no.  |    |
|-----------------|-------------|------------------|---------|---------------------|---------------|-----------|----|
| three-way valve | 4,5         | 2                | 53.15   | 10                  | 47.95         | 8610-0001 | N4 |
| three-way valve | 6,8         | 3                | 53.15   | 10                  | 47.95         | 8610-0003 | N4 |
| three-way valve | 10          | 4                | 68.90   | 10                  | 60.15         | 8610-0006 | N4 |
| two-way valve   | 4,5         | 2                | 31.90   | 10                  | 28.85         | 8610-0010 | N4 |
| two-way valve   | 6,8         | 3                | 31.90   | 10                  | 28.85         | 8610-0012 | N4 |
| two-way valve   | 10          | 4                | 42.70   | 10                  | 38.25         | 8610-0015 | N4 |

## Hose tubing stop-cock



Simple reflux nozzle with two-sided hose nozzle.

- ▶ HDPE natural
- ▶ Resistant to acids and chemicals
- ▶ Pressure resistant up to 0.3 bar

### Hose tubing stop-cock

| For dia. mm | Nominal width mm | Length mm | Price € | Quantity scale from | Scale price € | Item no.  |    |
|-------------|------------------|-----------|---------|---------------------|---------------|-----------|----|
| 9-11        | 7                | 85        | 3.46    | 50                  | 3.04          | 8614-0007 | N4 |
| 12-15       | 9                | 97        | 5.55    | 50                  | 4.96          | 8614-0009 | N4 |

## Non-return valves with conical inlet/outlet



Retaining valve with embossed directional arrow or printed in black. With conical nozzles. Various uses.

- ▶ Resistant to compression max. 4 bar
- ▶ Operating temperature +0 to +40 °C
- ▶ With PP valve ball, on request also with ball made of stainless steel or PTFE

### Non-return valves with conical inlet/outlet

| For dia. mm | Print    | Price € | Quantity scale from | Scale price € | Item no.     |  |
|-------------|----------|---------|---------------------|---------------|--------------|--|
| ① 6-8       | embossed | 2.45    | 100                 | 2.23          | 8714-0060 N4 |  |
| ① 8-10      | embossed | 2.45    | 100                 | 2.23          | 8714-0080 N4 |  |
| ① 10-14     | embossed | 3.06    | 100                 | 2.42          | 8714-0100 N4 |  |
| ② 6-8       | black    | 2.68    | 100                 | 2.46          | 8714-1006 N4 |  |
| ② 8-10      | black    | 2.68    | 50                  | 2.46          | 8714-1008 N4 |  |
| ② 10-14     | black    | 3.29    | 100                 | 2.65          | 8714-1010 N4 |  |

## Non-return valves PP



Valve made of PP and POM, seal made of EPDM, springs made of stainless steel 1.4401.

- ▶ Max. operating pressure 6 bar (at + 20°C)
- ▶ Max. operating temperature 80°C
- ▶ Pressure difference 12 mbar

### Non-return valves PP

| Thread | Price € | Quantity scale from | Scale price € | Item no.     |  |
|--------|---------|---------------------|---------------|--------------|--|
| 1/2"   | 11.70   | 5                   | 10.55         | 8540-0012 N3 |  |

## Rapid couplings



Fast and safe connection for liquids, gases, compressed air and vacuum. Rapid couplings are the ideal when connecting and separating hoses, machines, apparatus, containers, etc. Top quality, with tested reliability, small space requirement, maximum possible flow, easy operation (single handed operation) and an elegant design distinguish the rapid couplings. They fulfil the most stringent requirements. The couplings are available in two different materials: POM (Polyoxymethylene) and PP (Polypropylene). The rapid couplings are available with a hose nozzle, hose screw joint, thread connector or as a built-in component for control panels, with or without stop-valve respectively.

The secure O-ring guarantees that rapid couplings are leakproof. All the couplings (female connections) and nipples (male connections) that are within the same flow range are interconnecting.

- ▶ Spring/lock Stainless steel V4A

#### Body POM:

- ▶ Seal (standard): Buna-N
- ▶ Operating pressure at 20 °C: with vacuum up to 10 bar
- ▶ Operating temperature: -40 °C to +80 °C

#### Body PP:

- ▶ Seal (standard): EPDM
- ▶ Operating pressure at 20 °C: up to 8 bar
- ▶ Operating temperature: 0 °C to +110 °C

#### Use

1. The couplings are simply connected to each other, automatically clicking into place and opening the valves.
2. When disconnecting, (one handed operation), the valves are automatically sealed, no leakage occurs.

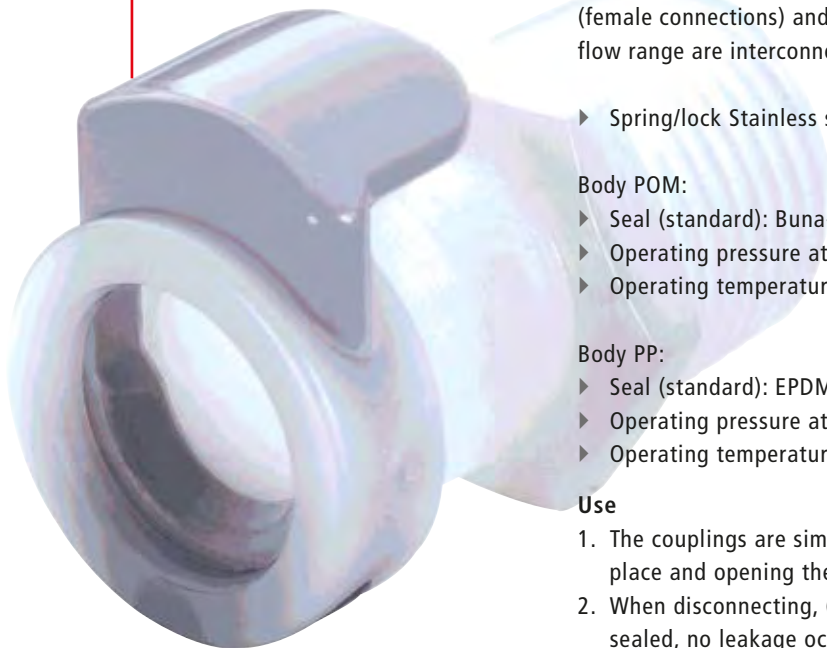

## Hose couplings, 100 % plastic (POM), nw 6.4 mm



### Hose couplings, 100 % plastic (POM), nw 6.4 mm, complete

| Model                             | Hose inner dia. mm | Connector type | Nominal width mm | Length mm | Price € | Quantity scale from | Scale price € | Item no.     |
|-----------------------------------|--------------------|----------------|------------------|-----------|---------|---------------------|---------------|--------------|
| coupling, complete, without valve | 6,4                | hose nozzle    | 6,4              | 54        | 5.35    | 25                  | 4.88          | 8780-1040 N3 |
| coupling, complete, without valve | 9,5                | hose nozzle    | 6,4              | 54        | 5.35    | 25                  | 4.88          | 8780-1060 N3 |



### Hose couplings, 100 % plastic (POM), nw 6.4 mm, male connections, hose nipples with hose nozzles

| Model                 | Hose inner dia. mm | Connector type | Nominal width mm | Length mm | Price € | Quantity scale from | Scale price € | Item no.     |
|-----------------------|--------------------|----------------|------------------|-----------|---------|---------------------|---------------|--------------|
| nipple, without valve | 6,4                | hose nozzle    | 6,4              | 36        | 1.97    | 25                  | 1.85          | 8782-1040 N3 |
| nipple, without valve | 9,5                | hose nozzle    | 6,4              | 36        | 1.97    | 25                  | 1.85          | 8782-1060 N3 |



### Hose couplings, 100 % plastic (POM), nw 6.4 mm, male connections, angled nipples with hose nozzle

| Model                        | Hose inner dia. mm | Connector type | Nominal width mm | Length mm | Price € | Quantity scale from | Scale price € | Item no.     |
|------------------------------|--------------------|----------------|------------------|-----------|---------|---------------------|---------------|--------------|
| angled-nipple, without valve | 9,5                | hose nozzle    | 6,4              | 23        | 4.63    | 25                  | 4.27          | 8783-1060 N3 |



### Hose couplings, 100 % plastic (POM), nw 6.4 mm, female connections, hose couplings with hose nozzles

| Model                   | Hose inner dia. mm | Connector type | Nominal width mm | Length mm | Price € | Quantity scale from | Scale price € | Item no.     |
|-------------------------|--------------------|----------------|------------------|-----------|---------|---------------------|---------------|--------------|
| coupling, without valve | 6,4                | hose nozzle    | 6,4              | 34        | 3.51    | 25                  | 3.26          | 8781-1040 N3 |
| coupling, without valve | 9,5                | hose nozzle    | 6,4              | 34        | 3.51    | 25                  | 3.26          | 8781-1060 N3 |



### Hose couplings, 100 % plastic (POM), nw 6.4 mm, female connections, hose couplings with conical external thread

| Model                   | Thread   | Connector type | Nominal width mm | Length mm | Price € | Quantity scale from | Scale price € | Item no.     |
|-------------------------|----------|----------------|------------------|-----------|---------|---------------------|---------------|--------------|
| coupling, without valve | 3/8" NPT | thread         | 6,4              | 35        | 5.65    | 25                  | 5.30          | 8783-1062 N3 |

# Rapid couplings, nw 3.2 mm, female connections



## Rapid couplings, nw 3.2 mm, female connections, hose couplings with conical external thread 2 weeks

| Thread   | Material | Model      | Length mm | Price € | Quantity scale from | Scale price € | Item no.     |
|----------|----------|------------|-----------|---------|---------------------|---------------|--------------|
| 1/8" NPT | POM      | with valve | 26        | 12.25   | 25                  | 11.40         | 8740-1122 N3 |
| 1/4" NPT | POM      | with valve | 28        | 12.25   | 25                  | 11.40         | 8740-1142 N3 |
| 1/4" BSP | POM      | with valve | 28        | 12.95   | 25                  | 11.90         | 8740-1141 N3 |
| 1/8" NPT | PP       | with valve | 26        | 14.60   | 25                  | 13.40         | 8740-2022 N3 |



## Rapid couplings, nw 3.2 mm, female connections, hose couplings with hose nozzles 2 weeks

| Hose inner dia. mm | Material | Model         | Length mm | Price € | Quantity scale from | Scale price € | Item no.     |
|--------------------|----------|---------------|-----------|---------|---------------------|---------------|--------------|
| 3,2                | POM      | with valve    | 42        | 12.40   | 25                  | 11.60         | 8741-1202 N3 |
| 4,8                | POM      | with valve    | 47        | 12.95   | 25                  | 11.90         | 8741-1203 N3 |
| 6,4                | POM      | with valve    | 47        | 12.40   | 25                  | 11.60         | 8741-1204 N3 |
| 3,2                | POM      | without valve | 42        | 8.65    | 25                  | 8.05          | 8741-1002 N3 |
| 4,8                | POM      | without valve | 47        | 8.95    | 25                  | 8.35          | 8741-1003 N3 |
| 6,4                | POM      | without valve | 47        | 8.65    | 25                  | 8.05          | 8741-1004 N3 |
| 3,2                | PP       | with valve    | 42        | 13.75   | 25                  | 13.65         | 8741-2002 N3 |



## Rapid couplings, nw 3.2 mm, female connections, hose couplings with hose screw-joint 2 weeks

| Hose inner x outer dia. mm | Material | Model      | Length mm | Price € | Quantity scale from | Scale price € | Item no.     |
|----------------------------|----------|------------|-----------|---------|---------------------|---------------|--------------|
| 4 x 6                      | POM      | with valve | 44        | 13.15   | 25                  | 12.15         | 8742-1104 N3 |
| 4 x 6                      | PP       | with valve | 44        | 21.30   | 25                  | 19.55         | 8742-2004 N3 |



## Rapid couplings, nw 3.2 mm, female connections, for plate mounting with hose nozzle 2 weeks

| Hose inner dia. mm | Material | Model      | Plate borehole dia. mm | Length mm | Price € | Quantity scale from | Scale price € | Item no.     |
|--------------------|----------|------------|------------------------|-----------|---------|---------------------|---------------|--------------|
| 1,6                | POM      | with valve | 13                     | 36        | 18.80   | 25                  | 17.25         | 8743-1101 N3 |
| 3,2                | POM      | with valve | 13                     | 42        | 17.25   | 25                  | 15.95         | 8743-1102 N3 |
| 4,8                | POM      | with valve | 13                     | 47        | 17.55   | 25                  | 16.15         | 8743-1103 N3 |
| 6,4                | POM      | with valve | 13                     | 47        | 17.55   | 25                  | 16.15         | 8743-1104 N3 |
| 1,6                | PP       | with valve | 13                     | 36        | 22.30   | 25                  | 20.45         | 8743-2001 N3 |
| 6,4                | PP       | with valve | 13                     | 47        | 21.30   | 25                  | 19.55         | 8743-2004 N3 |



## Rapid couplings, nw 3.2 mm, female connections, for plate mounting with hole screw-joint 2 weeks

| Plate borehole dia. mm | Material | Model         | Hose inner x outer dia. mm | Length mm | Price € | Quantity scale from | Scale price € | Item no.     |
|------------------------|----------|---------------|----------------------------|-----------|---------|---------------------|---------------|--------------|
| 13                     | POM      | with valve    | 4 x 6                      | 44        | 17.75   | 25                  | 16.40         | 8744-1104 N3 |
| 13                     | POM      | without valve | 4 x 6                      | 44        | 16.05   | 25                  | 14.60         | 8744-1004 N3 |
| 13                     | PP       | with valve    | 4 x 6                      | 44        | 22.55   | 25                  | 20.75         | 8744-2004 N3 |



# Rapid couplings, nw 3.2 mm, male connections



## Rapid couplings, nw 3.2 mm, male connections, hose nipples with external thread 2 weeks

| Thread   | Material | Model         | Length mm | Price € | Quantity scale from | Scale price € | Item no.     |
|----------|----------|---------------|-----------|---------|---------------------|---------------|--------------|
| 1/8" NPT | POM      | without valve | 15        | 4.16    | 25                  | 3.92          | 8750-1022 N3 |
| 1/8" BSP | POM      | with valve    | 22        | 12.75   | 25                  | 11.80         | 8750-1121 N3 |

## Rapid couplings, nw 3.2 mm, male connections, hose nipples with hose nozzles 2 weeks

| Hose inner dia. mm | Material | Model         | Length mm | Price € | Quantity scale from | Scale price € | Item no.     |
|--------------------|----------|---------------|-----------|---------|---------------------|---------------|--------------|
| 1,6                | POM      | without valve | 20        | 3.61    | 25                  | 3.38          | 8751-1001 N3 |
| 3,2                | POM      | without valve | 27        | 2.24    | 25                  | 2.09          | 8751-1002 N3 |
| 4,8                | POM      | without valve | 32        | 2.63    | 25                  | 2.50          | 8751-1003 N3 |
| 6,4                | POM      | without valve | 32        | 2.77    | 25                  | 2.63          | 8751-1004 N3 |
| 1,6                | POM      | with valve    | 34        | 13.50   | 25                  | 12.40         | 8751-1101 N3 |
| 3,2                | POM      | with valve    | 42        | 12.15   | 25                  | 11.20         | 8751-1102 N3 |
| 4,8                | POM      | with valve    | 44        | 12.25   | 25                  | 11.50         | 8751-1103 N3 |
| 6,4                | POM      | with valve    | 40        | 12.15   | 25                  | 11.20         | 8751-1104 N3 |
| 1,6                | PP       | with valve    | 34        | 17.95   | 25                  | 16.60         | 8751-2101 N3 |
| 3,2                | PP       | with valve    | 43        | 13.75   | 25                  | 12.75         | 8751-2102 N3 |
| 6,4                | PP       | with valve    | 40        | 15.95   | 25                  | 14.45         | 8751-2104 N3 |

## Rapid couplings, nw 3.2 mm, male connections, hose nipple with hose screw-joint 2 weeks

| Hose inner x outer dia. mm | Material | Model         | Length mm | Price € | Quantity scale from | Scale price € | Item no.     |
|----------------------------|----------|---------------|-----------|---------|---------------------|---------------|--------------|
| 4 x 6                      | POM      | without valve | 37        | 6.05    | 25                  | 5.50          | 8752-1004 N3 |
| 4 x 6                      | POM      | with valve    | 37        | 11.80   | 25                  | 10.90         | 8752-1104 N3 |
| 2 x 4                      | POM      | with valve    | 27        | 13.40   | 25                  | 12.25         | 8752-1142 N3 |
| 4 x 6                      | PP       | with valve    | 37        | 16.15   | 25                  | 14.90         | 8752-2104 N3 |

## Rapid couplings, nw 3.2 mm, male connections, for plate mounting with hose nozzle 2 weeks

| Hose inner dia. mm | Material | Model      | Plate borehole dia. mm | Length mm | Price € | Quantity scale from | Scale price € | Item no.     |
|--------------------|----------|------------|------------------------|-----------|---------|---------------------|---------------|--------------|
| 3,2                | POM      | with valve | 13                     | 41        | 16.90   | 25                  | 15.60         | 8753-1102 N3 |
| 4,8                | POM      | with valve | 13                     | 46        | 17.75   | 25                  | 16.40         | 8753-1103 N3 |
| 6,4                | POM      | with valve | 13                     | 46        | 17.45   | 25                  | 16.05         | 8753-1104 N3 |

## Rapid couplings, nw 3.2 mm, male connections, for plate mounting with hose screw-joint 2 weeks

| Hose inner x outer dia. mm | Material | Model      | Plate borehole dia. mm | Length mm | Price € | Quantity scale from | Scale price € | Item no.     |
|----------------------------|----------|------------|------------------------|-----------|---------|---------------------|---------------|--------------|
| 4 x 6                      | POM      | with valve | 13                     | 43        | 21.00   | 25                  | 19.35         | 8754-1104 N3 |

## Rapid couplings, nw 3.2 mm, male connections, angled nipples with hose nozzle 2 weeks

| Hose inner dia. mm | Material | Model      | Length mm | Price € | Quantity scale from | Scale price € | Item no.     |
|--------------------|----------|------------|-----------|---------|---------------------|---------------|--------------|
| 3,2                | POM      | with valve | 28        | 17.30   | 25                  | 15.95         | 8755-1102 N3 |
| 6,4                | POM      | with valve | 28        | 17.30   | 25                  | 15.95         | 8755-1104 N3 |
| 6,4                | PP       | with valve | 28        | 21.30   | 25                  | 19.60         | 8755-2004 N3 |

## Rapid couplings, nw 6.4 mm, female connections



### Rapid couplings, nw 6.4 mm, female connections, hose couplings with conical external thread

| Thread   | Material | Model         | Length mm | Price € | Quantity scale from | Scale price € | Item no.     |
|----------|----------|---------------|-----------|---------|---------------------|---------------|--------------|
| 1/4" BSP | POM      | without valve | 29        | 11.90   | 25                  | 11.00         | 8760-1041 N3 |
| 1/4" NPT | POM      | without valve | 29        | 11.90   | 25                  | 11.00         | 8760-1042 N3 |
| 3/8" BSP | POM      | without valve | 29        | 12.15   | 25                  | 11.40         | 8760-1061 N3 |
| 1/4" BSP | POM      | with valve    | 29        | 13.40   | 25                  | 12.25         | 8760-1141 N3 |
| 1/4" NPT | POM      | with valve    | 29        | 13.40   | 25                  | 12.25         | 8760-1142 N3 |
| 1/4" NPT | PP       | with valve    | 29        | 16.40   | 25                  | 15.20         | 8760-2141 N3 |
| 3/8" NPT | PP       | with valve    | 29        | 22.15   | 25                  | 20.35         | 8760-2161 N3 |



### Rapid couplings, nw 6.4 mm, female connections, hose couplings with hose nozzles

| Hose inner dia. mm | Material | Model         | Length mm | Price € | Quantity scale from | Scale price € | Item no.     |
|--------------------|----------|---------------|-----------|---------|---------------------|---------------|--------------|
| 6,5                | POM      | without valve | 50        | 11.40   | 25                  | 10.35         | 8761-1040 N3 |
| 8                  | POM      | without valve | 50        | 11.40   | 25                  | 10.35         | 8761-1050 N3 |
| 9,5                | POM      | without valve | 50        | 11.40   | 25                  | 10.35         | 8761-1060 N3 |
| 6,5                | POM      | with valve    | 50        | 13.60   | 25                  | 12.55         | 8761-1140 N3 |
| 8                  | POM      | with valve    | 50        | 13.60   | 25                  | 12.55         | 8761-1150 N3 |
| 9,5                | POM      | with valve    | 50        | 13.60   | 25                  | 12.55         | 8761-1160 N3 |
| 6,5                | PP       | with valve    | 50        | 17.85   | 25                  | 16.50         | 8761-2140 N3 |
| 9,5                | PP       | with valve    | 50        | 21.80   | 25                  | 20.10         | 8761-2160 N3 |



### Rapid couplings, nw 6.4 mm, female connections, for plate mounting with hose nozzle

| Hose inner dia. mm | Material | Model         | Plate borehole dia. mm | Length mm | Price € | Quantity scale from | Scale price € | Item no.     |
|--------------------|----------|---------------|------------------------|-----------|---------|---------------------|---------------|--------------|
| 6,5                | POM      | without valve | 19                     | 50        | 22.90   | 25                  | 21.10         | 8763-1040 N3 |
| 8                  | POM      | without valve | 19                     | 50        | 24.15   | 25                  | 21.95         | 8763-1050 N3 |
| 6,5                | POM      | with valve    | 19                     | 50        | 25.65   | 25                  | 23.50         | 8763-1140 N3 |
| 8                  | POM      | with valve    | 19                     | 50        | 27.00   | 25                  | 24.70         | 8763-1150 N3 |
| 9,5                | POM      | with valve    | 19                     | 50        | 25.65   | 25                  | 23.50         | 8763-1160 N3 |
| 9,5                | PP       | with valve    | 19                     | 50        | 29.20   | 25                  | 26.90         | 8763-2160 N3 |



### Rapid couplings, nw 6.4 mm, female connections, hose couplings with hose screw-joint

| Hose inner x outer dia. mm | Material | Model      | Length mm | Price € | Quantity scale from | Scale price € | Item no.     |
|----------------------------|----------|------------|-----------|---------|---------------------|---------------|--------------|
| 4 x 6                      | POM      | with valve | 47        | 19.55   | 25                  | 17.75         | 8762-1140 N3 |
| 8 x 10                     | POM      | with valve | 50        | 22.15   | 25                  | 20.35         | 8762-1310 N3 |
| 6 x 8                      | POM      | with valve | 50        | 21.00   | 25                  | 19.35         | 8762-1380 N3 |

## Rapid couplings, nw 6.4 mm, male connections



### Rapid couplings, nw 6.4 mm, male connections, hose nipples with external thread

| Thread   | Material | Model         | Length mm | Price € | Quantity scale from | Scale price € | Item no.     |
|----------|----------|---------------|-----------|---------|---------------------|---------------|--------------|
| 1/4" NPT | POM      | with valve    | 38        | 13.50   | 25                  | 12.55         | 8770-1142 N3 |
| 1/4" BSP | POM      | without valve | 32        | 4.46    | 25                  | 4.03          | 8770-1041 N3 |
| 1/4" NPT | POM      | without valve | 32        | 4.46    | 25                  | 4.03          | 8770-1042 N3 |
| 1/4" NPT | PP       | with valve    | 38        | 18.50   | 25                  | 17.00         | 8770-2142 N3 |



### Rapid couplings, nw 6.4 mm, male connections, hose nipples with hose nozzles

| Hose inner dia. mm | Material | Model         | Length mm | Price € | Quantity scale from | Scale price € | Item no.     |
|--------------------|----------|---------------|-----------|---------|---------------------|---------------|--------------|
| 6,5                | POM      | without valve | 32        | 2.89    | 25                  | 2.50          | 8771-1040 N3 |
| 8                  | POM      | without valve | 32        | 2.89    | 25                  | 2.50          | 8771-1050 N3 |
| 9,5                | POM      | without valve | 32        | 2.89    | 25                  | 2.50          | 8771-1060 N3 |
| 6,5                | POM      | with valve    | 47        | 13.40   | 25                  | 12.40         | 8771-1140 N3 |
| 8                  | POM      | with valve    | 47        | 13.40   | 25                  | 12.40         | 8771-1150 N3 |
| 9,5                | POM      | with valve    | 42        | 13.40   | 25                  | 12.40         | 8771-1160 N3 |
| 6,5                | PP       | with valve    | 47        | 15.95   | 25                  | 14.45         | 8771-2140 N3 |
| 9,5                | PP       | with valve    | 42        | 17.45   | 25                  | 16.05         | 8771-2160 N3 |



### Rapid couplings, nw 6.4 mm, male connections, for plate mounting with hose nozzle

| Hose inner dia. mm | Material | Model         | Plate borehole dia. mm | Length mm | Price € | Quantity scale from | Scale price € | Item no.     |
|--------------------|----------|---------------|------------------------|-----------|---------|---------------------|---------------|--------------|
| 6,5                | POM      | without valve | 19                     | 35        | 8.05    | 25                  | 7.35          | 8773-1040 N3 |
| 9,5                | POM      | without valve | 19                     | 47        | 10.35   | 25                  | 9.30          | 8773-1060 N3 |
| 6,5                | POM      | with valve    | 19                     | 49        | 17.65   | 25                  | 16.30         | 8773-1140 N3 |
| 8                  | POM      | with valve    | 19                     | 49        | 18.80   | 25                  | 17.45         | 8773-1150 N3 |
| 9,5                | POM      | with valve    | 19                     | 49        | 22.90   | 25                  | 21.10         | 8773-1160 N3 |



### Rapid couplings, nw 6.4 mm, male connections, hose nipple with hose screw-joint

| Hose inner x outer dia. mm | Material | Model         | Length mm | Price € | Quantity scale from | Scale price € | Item no.     |
|----------------------------|----------|---------------|-----------|---------|---------------------|---------------|--------------|
| 4 x 6                      | POM      | with valve    | 45        | 15.75   | 25                  | 14.35         | 8772-1140 N3 |
| 6 x 8                      | POM      | with valve    | 43        | 17.75   | 25                  | 16.40         | 8772-1380 N3 |
| 8 x 10                     | POM      | with valve    | 43        | 23.35   | 25                  | 21.50         | 8772-1310 N3 |
| 6 x 8                      | POM      | without valve | 35        | 13.75   | 25                  | 12.75         | 8772-1280 N3 |



### Rapid couplings, nw 6.4 mm, male connections, for plate mounting with hose screw-joint

| Hose inner x outer dia. mm | Material | Model      | Plate borehole dia. mm | Length mm | Price € | Quantity scale from | Scale price € | Item no.     |
|----------------------------|----------|------------|------------------------|-----------|---------|---------------------|---------------|--------------|
| 4 x 6                      | POM      | with valve | 19                     | 45        | 16.90   | 25                  | 15.60         | 8774-1140 N3 |
| 6 x 8                      | POM      | with valve | 19                     | 49        | 22.55   | 25                  | 20.75         | 8774-1380 N3 |



### Rapid couplings, nw 6.4 mm, male connections, angled nipples with hose nozzle

| Hose inner dia. mm | Material | Model         | Length mm | Price € | Quantity scale from | Scale price € | Item no.     |
|--------------------|----------|---------------|-----------|---------|---------------------|---------------|--------------|
| 6,5                | POM      | without valve | 31        | 10.55   | 25                  | 9.75          | 8775-1040 N3 |
| 9,5                | POM      | without valve | 31        | 10.55   | 25                  | 9.75          | 8775-1060 N3 |
| 9,5                | POM      | with valve    | 31        | 16.90   | 25                  | 15.60         | 8775-1160 N3 |
| 6,5                | PP       | with valve    | 31        | 19.80   | 25                  | 17.95         | 8775-2140 N3 |

## Threaded fittings



▶ PP

Hose nozzle with strong outer thread.

### Tube nozzles, fixed, external thread

| Thread | Nozzle dia. mm | Nominal width mm | Price € | Quantity scale from | Scale price € | Item no.     |
|--------|----------------|------------------|---------|---------------------|---------------|--------------|
| 3/8"   | 12             | 7,5              | 0.88    | 20                  | 0.81          | 8545-3812 N3 |
| 1/2"   | 13             | 8                | 1.13    | 20                  | 1.02          | 8545-0012 N3 |
| 1/2"   | 16             | 10               | 1.37    | 20                  | 1.26          | 8545-1216 N3 |
| 1/2"   | 20             | 13               | 1.45    | 20                  | 1.33          | 8545-1220 N3 |
| 3/4"   | 12             | 7,5              | 1.27    | 20                  | 1.14          | 8545-3412 N3 |
| 3/4"   | 16             | 10               | 1.29    | 20                  | 1.17          | 8545-0034 N3 |
| 3/4"   | 20             | 13               | 1.46    | 20                  | 1.34          | 8545-3420 N3 |
| 1"     | 25             | 19               | 1.58    | 10                  | 1.45          | 8545-0100 N3 |



▶ Hose nozzle, PP  
▶ Seal, EPDM

Hose nozzle with cap nut, inner thread.

### Tube nozzles, with cap nut

| Thread | Nozzle dia. mm | Nominal width mm | Price € | Quantity scale from | Scale price € | Item no.     |
|--------|----------------|------------------|---------|---------------------|---------------|--------------|
| 1/2"   | 13             | 9                | 2.09    | 20                  | 1.90          | 8546-0012 N3 |
| 1/2"   | 16             | 10               | 2.38    | 20                  | 2.15          | 8546-1216 N3 |
| 3/4"   | 10             | 6                | 2.64    | 20                  | 2.58          | 8546-3410 N3 |
| 3/4"   | 12             | 7,5              | 2.39    | 20                  | 2.19          | 8546-3412 N3 |
| 3/4"   | 13             | 8,5              | 2.78    | 20                  | 2.64          | 8546-3413 N3 |
| 3/4"   | 16             | 10               | 2.24    | 20                  | 2.04          | 8546-0034 N3 |
| 3/4"   | 20             | 13               | 2.60    | 20                  | 2.35          | 8546-3420 N3 |
| 1"     | 25             | 20               | 2.61    | 10                  | 2.36          | 8546-0100 N3 |



▶ PP

Hose angle bracket, 90°, with strong outer thread.

### Tube bend, fixed, external thread

| Thread | Nozzle dia. mm | Nominal width mm | Price € | Quantity scale from | Scale price € | Item no.     |
|--------|----------------|------------------|---------|---------------------|---------------|--------------|
| 1/2"   | 12             | 7,5              | 1.92    | 20                  | 1.76          | 8547-0012 N3 |
| 1/2"   | 16             | 11               | 2.39    | 20                  | 2.19          | 8547-1216 N3 |
| 1/2"   | 20             | 15               | 2.61    | 20                  | 2.35          | 8547-1220 N3 |
| 3/4"   | 12             | 7,5              | 1.97    | 20                  | 1.81          | 8547-0034 N3 |
| 3/4"   | 20             | 15               | 2.76    | 20                  | 2.51          | 8547-3420 N3 |
| 3/4"   | 22             | 17               | 2.66    | 20                  | 2.42          | 8547-3422 N3 |
| 1"     | 25             | 19,5             | 2.80    | 10                  | 2.54          | 8547-0100 N3 |



▶ Hose angle bracket, PP  
▶ Seal, EPDM

Hose angle bracket, 90°, with cap nut, inner thread and reducing nozzle.

### Tube bend, with cap nut

| Thread | Nozzle dia. mm | Nominal width mm | Price € | Quantity scale from | Scale price € | Item no.     |
|--------|----------------|------------------|---------|---------------------|---------------|--------------|
| 1/2"   | 12             | 7,5              | 3.07    | 20                  | 2.78          | 8548-0012 N3 |
| 3/4"   | 12             | 7                | 3.79    | 20                  | 3.38          | 8548-3412 N3 |
| 3/4"   | 16             | 11               | 3.56    | 20                  | 3.20          | 8548-0034 N3 |
| 3/4"   | 20             | 15,5             | 4.09    | 20                  | 3.66          | 8548-3420 N3 |
| 1"     | 25             | 19,5             | 4.29    | 10                  | 3.92          | 8548-0100 N3 |

## Threaded fittings



▶ PP

Hose angle bracket, 90°, with cap nut, inner thread and reducing nozzle.

### Tube bend, with cap nut, white

| Thread   | Outlet dia. mm | Nominal width mm | Price € | Quantity scale from | Scale price € | Item no.  |    |
|----------|----------------|------------------|---------|---------------------|---------------|-----------|----|
| M29x1,75 | 9              | 15               | 3.38    | 20                  | 3.05          | 8548-0020 | N3 |
| M36x3    | 10             | 20               | 3.71    | 20                  | 3.34          | 8548-0025 | N3 |
| M42x3    | 11             | 25               | 4.87    | 10                  | 4.38          | 8548-0030 | N3 |



▶ PP

Container connector with outer thread, complete with EPDM seals, for easy mounting of thread in the sides of containers.

### Container connection, white

| Thread | Nominal width mm | Price € | Quantity scale from | Scale price € | Item no.  |    |
|--------|------------------|---------|---------------------|---------------|-----------|----|
| 1/2"   | 13,5             | 8.15    | 20                  | 7.30          | 8533-0012 | N3 |
| 3/4"   | 18               | 9.45    | 10                  | 8.55          | 8533-0034 | N3 |
| 1"     | 24               | 9.95    | 20                  | 9.05          | 8533-0100 | N3 |



Hexagonal nut with inner thread.

### Hexagonal nuts

| Thread | Material | Price € | Quantity scale from | Scale price € | Item no.  |    |
|--------|----------|---------|---------------------|---------------|-----------|----|
| 1/2"   | HDPE     | 2.02    | 10                  | 1.85          | 8537-0012 | N3 |
| 3/4"   | HDPE     | 2.30    | 10                  | 2.09          | 8537-0034 | N3 |
| 1"     | HDPE     | 2.51    | 10                  | 2.31          | 8537-0100 | N3 |
| 2"     | PP       | 3.76    | 10                  | 3.40          | 8537-0200 | N3 |



▶ PE

Flat seals made of Polyethylene, transparent fitting outer or inner thread.

### Flat seals, PE

| Thread | Model             | Pieces per pack | Price € | Quantity scale from | Scale price € | Item no.  |    |
|--------|-------------------|-----------------|---------|---------------------|---------------|-----------|----|
| 1/2"   | fits outer thread | 10              | 2.40    | 10                  | 2.18          | 8538-0012 | N3 |
| 3/4"   | fits outer thread | 10              | 2.49    | 10                  | 2.42          | 8538-0034 | N3 |
| 1"     | fits outer thread | 10              | 4.96    | 10                  | 4.50          | 8538-0100 | N3 |
| 2"     | fits outer thread | 10              | 12.05   | 10                  | 10.80         | 8538-0200 | N3 |
| 1/2"   | fits inner thread | 10              | 2.35    | 10                  | 2.12          | 8539-0012 | N3 |
| 3/4"   | fits inner thread | 10              | 2.43    | 10                  | 2.37          | 8539-0034 | N3 |
| 1"     | fits inner thread | 10              | 4.84    | 10                  | 4.46          | 8539-0100 | N3 |

# Threaded fittings

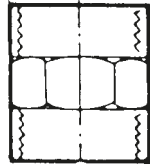

Socket with inner thread.

► PP

## Socket, inner thread

| Thread | Nominal width mm | Price € | Quantity scale from | Scale price € | Item no.     |
|--------|------------------|---------|---------------------|---------------|--------------|
| 1/2"   | 19               | 2.45    | 10                  | 2.24          | 8501-0012 N3 |
| 3/4"   | 23               | 3.00    | 10                  | 2.72          | 8501-0034 N3 |
| 1"     | 28,5             | 3.92    | 10                  | 3.56          | 8501-0100 N3 |

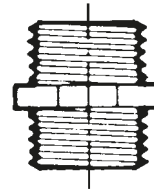

Nipple with outer thread.

► PP

## Nipple, outer thread

| Thread | Nominal width mm | Price € | Quantity scale from | Scale price € | Item no.     |
|--------|------------------|---------|---------------------|---------------|--------------|
| 1/2"   | 13,5             | 2.07    | 10                  | 1.88          | 8505-0012 N3 |
| 3/4"   | 18               | 2.61    | 10                  | 2.36          | 8505-0034 N3 |
| 1"     | 23,5             | 3.56    | 10                  | 3.20          | 8505-0100 N3 |

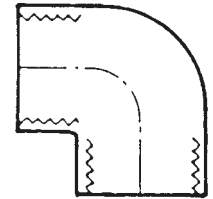

Angle bracket 90° with inner thread.

► PP

## 90° bend, inner thread

| Thread | Nominal width mm | Price € | Quantity scale from | Scale price € | Item no.     |
|--------|------------------|---------|---------------------|---------------|--------------|
| 1/2"   | 17,5             | 2.61    | 10                  | 2.36          | 8515-0012 N3 |
| 3/4"   | 23               | 3.66    | 10                  | 3.38          | 8515-0034 N3 |
| 1"     | 28,5             | 4.29    | 10                  | 3.92          | 8515-0100 N3 |

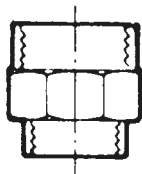

Socket, reduced with inner thread.

► PP

## Socket, reduced

| Thread    | Nominal width mm | Price € | Quantity scale from | Scale price € | Item no.     |
|-----------|------------------|---------|---------------------|---------------|--------------|
| 1/2"-3/4" | 17,5             | 4.29    | 10                  | 3.98          | 8502-1234 N3 |
| 3/4"-1"   | 23               | 5.35    | 10                  | 4.84          | 8502-3410 N3 |

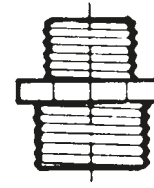

Nipple, reduced, with outer thread.

► PP

## Nipple, reduced

| Thread    | Nominal width mm | Price € | Quantity scale from | Scale price € | Item no.     |
|-----------|------------------|---------|---------------------|---------------|--------------|
| 1/2"-3/4" | 13,5             | 3.92    | 10                  | 3.56          | 8506-1234 N3 |
| 3/4"-1"   | 18               | 5.00    | 10                  | 4.58          | 8506-3410 N3 |

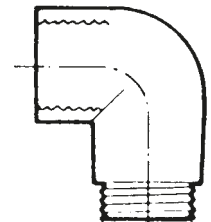

Angle bracket 90° with inner / outer thread.

► PP

## 90° bend, inner/outer thread

| Thread | Nominal width mm | Price € | Quantity scale from | Scale price € | Item no.     |
|--------|------------------|---------|---------------------|---------------|--------------|
| 1/2"   | 14               | 3.00    | 10                  | 2.72          | 8516-0012 N3 |
| 3/4"   | 19               | 4.29    | 10                  | 3.92          | 8516-0034 N3 |
| 1"     | 24,5             | 5.00    | 10                  | 4.52          | 8516-0100 N3 |

# Threaded fittings

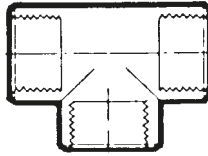

T piece with inner thread.

► PP

| T-piece |                  |         |                     |               |              |
|---------|------------------|---------|---------------------|---------------|--------------|
| Thread  | Nominal width mm | Price € | Quantity scale from | Scale price € | Item no.     |
| 1/2"    | 17,5             | 3.38    | 10                  | 3.00          | 8525-0012 N3 |
| 3/4"    | 23               | 4.59    | 10                  | 4.19          | 8525-0034 N3 |
| 1"      | 28,5             | 5.65    | 10                  | 5.10          | 8525-0100 N3 |

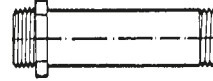

Tube extension with outer thread. 8520-0012, -0034 length 152 mm, 8520-0100 length 162 mm.

► PP

| Tube extensions |                  |         |                     |               |              |
|-----------------|------------------|---------|---------------------|---------------|--------------|
| Thread          | Nominal width mm | Price € | Quantity scale from | Scale price € | Item no.     |
| 1/2"            | 12,5             | 3.12    | 10                  | 2.82          | 8520-0012 N3 |
| 3/4"            | 18               | 4.09    | 10                  | 3.79          | 8520-0034 N3 |
| 1"              | 23,5             | 5.40    | 20                  | 5.00          | 8520-0100 N3 |

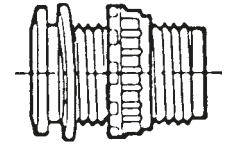

Container connector with outer thread, complete with EPDM seals, for easy mounting of thread in the sides of containers.

► PP

| Container connection |                  |         |                     |               |              |
|----------------------|------------------|---------|---------------------|---------------|--------------|
| Thread               | Nominal width mm | Price € | Quantity scale from | Scale price € | Item no.     |
| 1/2"                 | 13,5             | 7.30    | 10                  | 6.65          | 8530-0012 N3 |
| 3/4"                 | 18               | 8.35    | 10                  | 7.75          | 8530-0034 N3 |
| 1"                   | 24               | 9.60    | 10                  | 8.80          | 8530-0100 N3 |

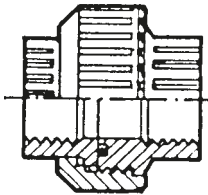
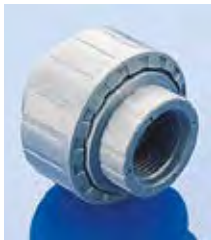

Screw joint with inner thread, enables easy disconnection of tube connections.

► PP

| Screw joint |                  |         |                     |               |              |
|-------------|------------------|---------|---------------------|---------------|--------------|
| Thread      | Nominal width mm | Price € | Quantity scale from | Scale price € | Item no.     |
| 1/2"        | 17,5             | 10.70   | 10                  | 9.85          | 8510-0012 N3 |
| 3/4"        | 21,5             | 11.95   | 10                  | 10.80         | 8510-0034 N3 |
| 1"          | 26,5             | 12.45   | 10                  | 11.45         | 8510-0100 N3 |



Closing cap with inner thread.

► PP

| Cap    |         |                     |               |              |
|--------|---------|---------------------|---------------|--------------|
| Thread | Price € | Quantity scale from | Scale price € | Item no.     |
| 1/2"   | 2.83    | 10                  | 2.58          | 8535-0012 N3 |
| 3/4"   | 3.56    | 10                  | 3.20          | 8535-0034 N3 |
| 1"     | 3.92    | 10                  | 3.56          | 8535-0100 N3 |

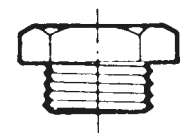
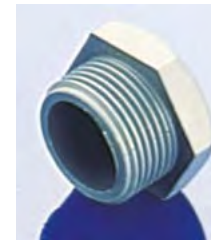

Threaded cap outer thread.

► PP

| Stopper |         |                     |               |              |
|---------|---------|---------------------|---------------|--------------|
| Thread  | Price € | Quantity scale from | Scale price € | Item no.     |
| 1/2"    | 2.07    | 10                  | 1.88          | 8536-0012 N3 |
| 3/4"    | 2.61    | 10                  | 2.36          | 8536-0034 N3 |
| 1"      | 3.26    | 10                  | 2.88          | 8536-0100 N3 |

## VacuMan vacuum pump

Hand pump can be operated with one hand to create a vacuum or pressure, independent of a power supply (e.g. vacuum filtration, taking samples, dissipation of desiccators). Maintenance-free, self-lubricating, mainly corrosion resistant. Connection for hoses with 6.4 mm inner Ø. Available in PVC or aluminium for heavy duty.



- ▶ With or without gauge
- ▶ Sampling set with suction hose and sample container and adapter set for hoses from 5 to 14 mm available as accessory

## VacuMan vacuum or pressure pump



- ▶ With gauge
- ▶ Adapter set for hoses from 5 to 14 mm available as accessory

### VacuMan vacuum pump

| Pressure gauge | Stroke approx. ml | Material | Vacuum mbar | Price € | Item no.  |    |
|----------------|-------------------|----------|-------------|---------|-----------|----|
| no             | 32                | PVC      | - 850       | 92.70   | 5620-0360 | N3 |
| yes            | 16                | PVC      | - 850       | 94.05   | 5620-1180 | N3 |
| yes            | 32                | PVC      | - 850       | 111.20  | 5620-1360 | N3 |

### Accessories

| Description   | Price € | Item no.     |
|---|---------|--------------|
| Adapter set for hoses from 5 to 14 mm               | 10.35   | 5620-0010 N3 |
| Sampling set with suction hose and sample container | 24.45   | 5620-0020 N3 |

### VacuMan vacuum or pressure pump

| Pressure gauge | Material  | Stroke approx. ml | Vacuum mbar | Pressure max. bar | Price € | Item no.  |    |  |
|----------------|-----------|-------------------|-------------|-------------------|---------|-----------|----|--|
| yes            | PVC       | 16                | - 850       | + 2               | 154.40  | 5620-2180 | N3 |  |
| yes            | aluminium | 16                | - 850       | + 2               | 261.85  | 5620-2181 | N3 |  |

### Accessories

| Description   | Price € | Item no.     |
|---|---------|--------------|
| Adapter set for hoses from 5 to 14 mm               | 10.35   | 5620-0010 N3 |
| Sampling set with suction hose and sample container | 24.45   | 5620-0020 N3 |



## Water-jet pump



- ▶ PP, PTFE, FKM
- ▶ Continuous use temperature max. 80°C
- ▶ Incl. reducing piece to 1/2"

The water jet pump is used for withdrawing liquids and gases, and for creating a vacuum. Simple operation and easy cleaning. Very low water consumption, constant pressure and high suction.

Suction tube connection: Olive 6 – 9 mm outer Ø, screw cap GL 14.  
Water consumption at 3.5 bar flow pressure and 12°C water temperature: approx. 190 l/hour at 3.5 bar (absolute). 6 l of water are needed to evacuate a 1 l pressure vessel from normal pressure to final pressure.

Suction capacity at 3.5 bar flow pressure and 12°C water temperature: 400 l/h evacuation time for a 1 l pressure vessel from normal pressure to 100 mbar: 60 sec. (± 10 sec.).

Final pressure at 3.5 bar flow pressure and 12°C water temperature: < 16 mbar.

The vacuum connection can be unscrewed and supplied adapters provide a variety of connection options to the water supply.

### Water-jet pump

| Price € | Quantity scale from | Scale price € | Item no.     |
|---------|---------------------|---------------|--------------|
| 45.10   | 10                  | 43.85         | 9668-0200 N3 |

### Accessories

| Description                                 | Price € | Item no.     |
|---|---------|--------------|
| Reducing adapter 3/8"                       | 5.95    | 9668-0010 N3 |
| Reducing adapter M 22 x 1 (perlator thread) | 5.85    | 9668-0011 N3 |

## AirJet Mini vacuum pump/compressor



The AirJet Mini single-head membrane vacuum pump is suitable for a variety of applications in the laboratory and industry. The dry running membrane vacuum pump is able to pump, compact and evacuate 100% oil-free, which means it does not distort results or add impurities, and can also be used as a compressor.

The AirJet Mini is used to pump and evacuate air and neutral or slightly aggressive or corrosive gases and vapours.

- ▶ Weight 1.9 kg, dimensions LxWxH 164/90/141 mm
- ▶ Hose connection ID 4 mm
- ▶ Maintenance-free, environmentally friendly
- ▶ High level of gas tightness
- ▶ Very quiet with low vibrations

**!** Attention! Make sure to pay attention to the "List of Chemical Resistance"!



### ① AirJet Mini membrane vacuum pump/compressor

| Model                 | Pump capacity approx. l/min | Vacuum mbar | Pressure max. bar | Price € | Item no.     |
|-----------------------|-----------------------------|-------------|-------------------|---------|--------------|
| Membrane made of EPDM | 6                           | 100         | 2,4               | 334.70  | 5625-2000 N2 |
| Membrane made of PTFE | 5,5                         | 160         | 2,5               | 404.30  | 5625-2001 N2 |

### Accessories

| Description                        | Price € | Item no.     |
|------------------------------------|---------|--------------|
| ② AirJet Mini fine regulation head | 72.95   | 5625-2002 N2 |
| ③ AirJet Mini sound absorber       | 12.35   | 5625-2003 N2 |

## Desiccator



Desiccators made of plastic, break resistant, lightweight and suitable for vacuums. Stopcock suitable for vacuums up to 980 mbar. Base and desiccator plate made out of Polypropylene. Lid is crystal clear Polycarbonate with a non-return valve and a venting valve. O-ring seal made of Polychlorobutadiene-rubber. Continuous temperature max. + 60 °C.

- ▶ Hose connection fits hoses with inner Ø 8.5 mm
- ▶ Delivery incl. O-ring
- ▶ Perforated plate and additional O-rings available as accessories

### Desiccator

| Inner dia. mm | Outer dia. mm | Height mm | Price € | Quantity scale from | Scale price € | Item no.     |
|---------------|---------------|-----------|---------|---------------------|---------------|--------------|
| 150           | 175           | 190       | 68.10   | 5                   | 52.85         | 9791-0150 N3 |
| 200           | 235           | 230       | 112.45  | 5                   | 101.25        | 9791-0200 N3 |
| 250           | 285           | 300       | 134.65  | 5                   | 123.60        | 9791-0250 N3 |

### Accessories

| Description                                      | Price € | Item no.     |
|--|---------|--------------|
| Perforated plates for desiccator for i.d. 150 mm | 7.50    | 9791-0151 N3 |
| Perforated plates for desiccator for i.d. 200 mm | 10.40   | 9791-0201 N3 |
| Perforated plates for desiccator for i.d. 250 mm | 11.50   | 9791-0251 N3 |
| O-ring for desiccator for i.d. 150 mm            | 3.46    | 9791-0152 N3 |
| O-ring for desiccator for i.d. 200 mm            | 4.68    | 9791-0202 N3 |
| O-ring for desiccator for i.d. 250 mm            | 6.85    | 9791-0252 N3 |

## Mercury collector



Bürkle's mercury collector enables the easy collection of spilt mercury, which can then be used again. The mercury collector is composed of a tub with a screw cap lid that has a special plastic foam inserted. On pressing this foam gently on the spilt mercury, the foam's pores are opened and the mercury globules are absorbed. The cap is then screwed on the tub, the globules are released again and fall through the perforated separation into the tub.

### Mercury collector

| Price € | Quantity scale from | Scale price € | Item no.     |
|---------|---------------------|---------------|--------------|
| 23.95   | 10                  | 21.60         | 9789-0001 N4 |

### Accessories

| Description                                     | Price € | Item no.     |
|---|---------|--------------|
| Spare plastic foam insert for mercury collector | 4.02    | 9789-0002 N4 |

## Eyes Fresh mini eyewash station



Mini eyewash station ideal for the lab, filling stations or all work places where aggressive substances are used. Eyes Fresh can be attached to any standard cold water tap. For normal use of the tap, just press the button and the function changes back from the eye wash (returns automatically to eyewash-function when the tap is closed). Can be fitted onto taps with M22x1, 1/2" or 3/8" outer thread. With sufficient water pressure provided, performance according to DIN EN 15154-2.

| Eyes Fresh mini eyewash station |         |                     |               | DIN          |
|---------------------------------|---------|---------------------|---------------|--------------|
| Model                           | Price € | Quantity scale from | Scale price € | Item no.     |
| Press button for normal use     | 137.05  | 5                   | 126.10        | 2515-0100 N4 |

## Eye rinsing bottle



Empty bottle for 600 ml contents, leakproof due to valve and dust protection cap. Instructions printed on (in German language), made of transparent PE.

| Eye rinsing bottle |                     |               |           | DIN |
|--------------------|---------------------|---------------|-----------|-----|
| Price €            | Quantity scale from | Scale price € | Item no.  |     |
| 30.10              | 10                  | 27.30         | 2507-2000 | N3  |
| Wall fixture       |                     |               |           |     |
| Price €            | Quantity scale from | Scale price € | Item no.  |     |
| 15.65              | 10                  | 15.00         | 2507-2001 | N3  |

## HotGrip



Hand protection made of silicone rubber highly resistant to cold and heat. Protects fingers and hands from burns and freezing when working with apparatus which has extreme temperatures. HotGrip is resistant to temperatures from  $-50\text{ }^{\circ}\text{C}$  to  $+200\text{ }^{\circ}\text{C}$  (briefly up to  $+250\text{ }^{\circ}\text{C}$ ). Deep frozen, hot or even boiling substances and apparatus can be safely handled and positioned. Silicone rubber is extremely elastic and slip-proof, so that even smooth surfaced apparatus such as hot glass flasks can be securely gripped.

### HotGrip



| Model                        | Colour | Price € | Quantity scale from | Scale price € | Item no.     |
|------------------------------|--------|---------|---------------------|---------------|--------------|
| for the whole hand           | red    | 22.85   | 10                  | 21.50         | 9768-0001 N3 |
| for thumb and one finger     | white  | 27.30   | 10                  | 25.90         | 9768-0002 N3 |
| for thumb and 2 to 3 fingers | white  | 35.30   | 10                  | 33.45         | 9768-0003 N3 |

## Rubiflex protective gloves



With short or long gauntlet. Safe working with fats, mineral oils, solvents and many acids and alkalis.

- ▶ Made from nitrile rubber
- ▶ Very flexible, soft to the touch
- ▶ High abrasion and cut resistance
- ▶ Comfortable cotton interlock interior
- ▶ To standard EN 374



Attention! Make sure to pay attention to the "List of Chemical Resistance"!

### Rubiflex protective gloves



| Model      | Length cm | Price € | Quantity scale from | Scale price € | Item no.     |
|------------|-----------|---------|---------------------|---------------|--------------|
| standard   | 37        | 23.95   | 10                  | 21.90         | 2507-0002 N3 |
| long wrist | 60        | 45.75   | 10                  | 41.65         | 2507-0003 N3 |

## Standard bungs silicone



The bungs are transparent, chemically-biologically neutral, food-safe according to BfR Recommendation XV and FDA § 177.2600.

- ▶ Temperature resistant from -60 °C to +200 °C, briefly to +230 °C
- ▶ Sterilisable
- ▶ Non-toxic

### Standard bungs silicone rubber

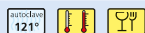

| Dia. bot-tom mm | Dia. top mm | Height mm | Price € | Quantity scale from | Scale price € | Item no.     |
|-----------------|-------------|-----------|---------|---------------------|---------------|--------------|
| 5               | 9           | 20        | 0.28    | 100                 | 0.24          | 9764-0610 N3 |
| 8               | 12          | 20        | 0.34    | 100                 | 0.32          | 9764-0913 N3 |
| 10,5            | 14,5        | 20        | 0.39    | 100                 | 0.36          | 9764-1115 N3 |
| 14              | 18          | 20        | 0.57    | 100                 | 0.54          | 9764-1418 N3 |
| 17              | 22          | 25        | 0.93    | 100                 | 0.90          | 9764-1621 N3 |
| 18              | 24          | 30        | 1.23    | 100                 | 1.20          | 9764-1924 N3 |
| 21              | 27          | 30        | 1.59    | 100                 | 1.47          | 9764-2227 N3 |
| 26              | 32          | 30        | 2.58    | 100                 | 2.36          | 9764-2531 N3 |
| 29              | 35          | 30        | 3.33    | 100                 | 2.97          | 9764-2834 N3 |

## Standard bungs



Laboratory standard bung made of PVC with good chemical resistance against acids and alkalis.

- ▶ PVC, soft, red



⚠ Attention! Make sure to pay attention to the "List of Chemical Resistance"!

### Standard bungs



| Dia. bot-tom mm | Dia. top mm | Height mm | Price € | Quantity scale from | Scale price € | Item no.     |
|-----------------|-------------|-----------|---------|---------------------|---------------|--------------|
| 7               | 10          | 18        | 0.42    | 100                 | 0.37          | 9763-0610 N3 |
| 9               | 13          | 20        | 0.49    | 100                 | 0.43          | 9763-0913 N3 |
| 11              | 15          | 20        | 0.61    | 100                 | 0.56          | 9763-1115 N3 |
| 14              | 18          | 20        | 1.91    | 100                 | 1.77          | 9763-1418 N3 |
| 16              | 21          | 24        | 2.28    | 100                 | 2.14          | 9763-1621 N3 |
| 19              | 24          | 25        | 2.34    | 100                 | 2.21          | 9763-1924 N3 |
| 22              | 27          | 24        | 2.64    | 100                 | 2.49          | 9763-2227 N3 |
| 25              | 31          | 29        | 2.77    | 100                 | 2.64          | 9763-2531 N3 |
| 28              | 34          | 30        | 2.85    | 100                 | 2.71          | 9763-2834 N3 |
| 31              | 38          | 33        | 3.01    | 100                 | 2.85          | 9763-3138 N3 |
| 34              | 41          | 35        | 2.74    | 100                 | 2.48          | 9763-3441 N3 |
| 42              | 49          | 34        | 3.70    | 100                 | 3.24          | 9763-4249 N3 |
| 46              | 53          | 39        | 4.48    | 100                 | 4.13          | 9763-4654 N3 |

## Bungs PE



Stopper made of PE, hollow with sealing rings and octagonal top.

- ▶ PE

### Bungs PE



| GGJ   | Dia. bot-tom mm | Dia. top mm | Price € | Quantity scale from | Scale price € | Item no.     |
|-------|-----------------|-------------|---------|---------------------|---------------|--------------|
| 7/16  | 5,9             | 7,5         | 0.31    | 100                 | 0.30          | 9760-0716 N3 |
| 10/19 | 8,2             | 10          | 0.43    | 100                 | 0.41          | 9760-1019 N3 |
| 12/21 | 10,4            | 12,5        | 0.51    | 100                 | 0.48          | 9760-1221 N3 |
| 14/23 | 12,1            | 14,5        | 0.54    | 100                 | 0.51          | 9760-1423 N3 |
| 19/26 | 16,4            | 19          | 0.63    | 100                 | 0.56          | 9760-1926 N3 |
| 24/29 | 21,1            | 24          | 0.74    | 100                 | 0.66          | 9760-2429 N3 |
| 29/32 | 25,8            | 29          | 0.95    | 100                 | 0.87          | 9760-2932 N3 |
| 34/35 | 31              | 34,5        | 1.80    | 100                 | 1.59          | 9760-3435 N3 |
| 45/40 | 41              | 45          | 2.16    | 100                 | 1.97          | 9760-4045 N3 |

# fish-clip



Compression-type bung made of silicone



Compression-type fitting



Compression-type fitting with NS core

With fish-clip cell cultures, abrasive media and other liquids that are sensitive to mechanical stress are gently stirred. No disruption of biocatalysts such as enzymes or cells. No scratching the vessel base, no broken vessels resulting from magnetic stirrer bars "jumping about". Also suitable for narrow vessel openings. fish-clip can be used for gentle stirring in any type of vessel such as beakers, bottles, Erlenmeyer and round-bottom flasks.

- ▶ PVDF, autoclavable, excellent chemical resistance
- ▶ Rotor 15 mm Ø
- ▶ Gas tight
- ▶ Support rod length 250 mm
- ▶ Incl. stirring bar

Magnetic stirrer is not supplied.

## fish-clip

| Colour | Fits to stirring bar dia. mm | Price € | Quantity scale from | Scale price € | Item no.     |
|--------|------------------------------|---------|---------------------|---------------|--------------|
| blue   | 6                            | 35.10   | 10                  | 33.20         | 8280-0006 N4 |
| red    | 8                            | 35.10   | 10                  | 33.20         | 8280-0008 N4 |

## Accessories

| Description  | Price € | Item no.     |
|--|---------|--------------|
| Compression-type in silicone for fish-clip, for NS 29/32         | 4.52    | 8280-0253 N4 |
| Compression-type in silicone for fish-clip, for NS 19/26         | 3.26    | 8280-0257 N4 |
| Compression-type fitting for fish-clip, GL 25, red               | 7.70    | 8280-0254 N4 |
| Compression-type fitting for fish-clip, GL 32, grey              | 11.65   | 8280-0255 N4 |
| Compression-type fitting for fish-clip, GL 25 with NS-cone 19/26 | 26.45   | 8280-0256 N4 |
| Compression-type fitting for fish-clip, GL 32 with NS-cone 29/32 | 29.00   | 8280-0321 N4 |
| Magnetic stirring bars, length 15 mm, dia. 6 mm                  | 1.90    | 8271-1506 N3 |
| Magnetic stirring bars, length 20 mm, dia. 6 mm                  | 1.90    | 8271-2006 N3 |
| Magnetic stirring bars, length 25 mm, dia. 6 mm                  | 2.18    | 8271-2506 N3 |
| Magnetic stirring bars, length 30 mm, dia. 6 mm                  | 2.24    | 8271-3006 N3 |
| Magnetic stirring bars, length 40 mm, dia. 8 mm                  | 2.63    | 8271-4008 N3 |
| Magnetic stirring bars, length 50 mm, dia. 8 mm                  | 3.38    | 8271-5008 N3 |

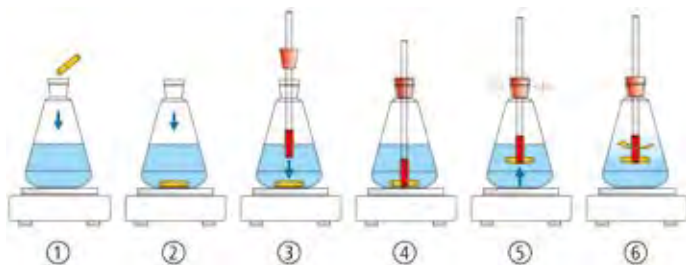

## Magnetic stirring bars



Cylindrical stirring bars with smooth surface, many uses.

- ▶ PTFE opaque
- ▶ Max. use temperature +270°C
- ▶ High performance permanent magnets and long lifespan

Magnetic stirring bar set consists of 10 of the most standard bars, complete with crystal clear box.

- ▶ 1 of each 15 x 6 mm, 30 x 7 mm
- ▶ 2 of each 20 x 7 mm, 25 x 7 mm, 40 x 7 mm, 50 x 7 mm

### Magnetic stirring bars

| Length mm | Dia. mm | For fish-clip | Price € | Quantity scale from | Scale price € | Item no.  |    |  |
|-----------|---------|---------------|---------|---------------------|---------------|-----------|----|--|
| 15        | 6       | yes           | 1.90    | 10                  | 1.62          | 8271-1506 | N3 |  |
| 20        | 6       | yes           | 1.90    | 10                  | 1.52          | 8271-2006 | N3 |  |
| 20        | 7       | no            | 2.53    | 10                  | 2.32          | 8271-2007 | N3 |  |
| 25        | 6       | yes           | 2.18    | 10                  | 1.75          | 8271-2506 | N3 |  |
| 25        | 7       | no            | 2.69    | 10                  | 2.45          | 8271-2507 | N3 |  |
| 30        | 6       | yes           | 2.24    | 10                  | 1.80          | 8271-3006 | N3 |  |
| 30        | 7       | no            | 3.06    | 10                  | 2.77          | 8271-3007 | N3 |  |
| 40        | 7       | no            | 3.92    | 10                  | 3.56          | 8271-4007 | N3 |  |
| 40        | 8       | yes           | 2.63    | 10                  | 2.09          | 8271-4008 | N3 |  |
| 50        | 7       | no            | 4.58    | 10                  | 4.22          | 8271-5007 | N3 |  |
| 50        | 8       | yes           | 3.38    | 10                  | 2.63          | 8271-5008 | N3 |  |
| 80        | 10      | no            | 7.95    | 10                  | 7.25          | 8271-8010 | N3 |  |

### Magnetic stirring bar set

| Model              | Price € | Quantity scale from | Scale price € | Item no.  |    |  |
|--------------------|---------|---------------------|---------------|-----------|----|--|
| set incl. ten bars | 35.90   | 5                   | 33.25         | 8271-1000 | N3 |  |

## Stirring paddle



Stirring paddle made of polypropylene for gentle stirring in plastic and glass containers.

- ▶ PP
- ▶ Shatterproof
- ▶ Warp resistant
- ▶ Total length 1,17 m or 1,71 m



### Stirring paddle

| Length mm | Width mm | Total length cm | Price € | Item no.  |    |
|-----------|----------|-----------------|---------|-----------|----|
| 155       | 130      | 117             | 36.10   | 8203-2100 | N3 |
| 190       | 167      | 171             | 43.30   | 8203-3150 | N3 |

# Chemical resistance

| Chemicals                 |   |               |             |             | Plastics |      |     |     |      |     |     |     |     |     |          |          |     |            |     |      |      |      |         |     |     |      |      |      |
|---------------------------|---|---------------|-------------|-------------|----------|------|-----|-----|------|-----|-----|-----|-----|-----|----------|----------|-----|------------|-----|------|------|------|---------|-----|-----|------|------|------|
| Formula                   | CAS-No.   | Concentration | Hazard note | Inflammable | HDPE     | LDPE | PA  | PC  | PETG | PMP | POM | PP  | PS  | PSU | PVC HARD | PVC SOFT | SAN | ECTFE/ETFE | FEP | PTFE | PVDF | EPDM | FKM/FKM | NBR | SI  | AL   | V2A  | V4A  |
| Acetone                   | C <sub>3</sub> H <sub>6</sub> O                                 | 000067-64-1   | F, Xi       | X           | 1/1      | 3/3  | 1/0 | 4/4 | 4/4  | 2/3 | 1/3 | 1/3 | 4/4 | 4/4 | 4/4      | 0/0      | 4/4 | 2/3        | (1) | 1/1  | 3/4  | 1/4  | 4/4     | 4/4 | 0/0 | 1/1  | 1/1  | 1/1  |
| Calcium chloride          | CaCl <sub>2</sub>   | 010043-52-4   | aqueous     | Xi          | 1/1      | 1/1  | 1/0 | 1/0 | 1/0  | 1/1 | (3) | 1/1 | 1/1 | 1/0 | 1/3      | 1/0      | 1/1 | 1/1        | 1/1 | 1/1  | 1/1  | 1/0  | 1/1     | 1/1 | 0/0 | 3/3  | 1/2L | 1/2L |
| Chlorine                  | Cl <sub>2</sub>   | 007782-50-5   | 10 % wet    | T           | 3/4      | 3/4  | 4/4 | 2/3 | 4/4  | 2/4 | 4/4 | 4/4 | 4/4 | 4/4 | 1/2      | 0/0      | 4/4 | 1/1        | 1/1 | 1/1  | (2)  | 2/0  | 3/0     | 4/4 | 0/0 | 4/4  | 4/4  | 4/4  |
| Chloroform                | CHCl <sub>3</sub>   | 000067-66-3   | 100 %       | Xn          | 3/4      | 4/4  | 3/4 | 4/4 | 4/4  | 4/4 | 4/4 | 3/4 | 4/4 | 4/4 | 4/4      | 4/4      | 4/4 | 2/3        | 1/1 | 1/1  | 1/1  | 4/4  | 3/4     | 4/4 | 0/0 | (3)  | 1/1  | 1/1  |
| Developer for fotos       | —   | —             | ?           |             | 1/3      | 1/1  | 4/4 | (2) | 1/0  | 0/0 | 1/3 | 1/2 | 0/0 | 1/0 | 1/3      | 1/0      | 0/0 | 0/0        | (1) | 1/1  | 1/1  | 3/0  | 1/0     | 1/0 | 0/0 | 1/1  | 1/0  | 1/0  |
| Ethyl alcohol             | C <sub>2</sub> H <sub>6</sub> O                                 | 000064-17-5   | 96 %        | F           | X        | 1/0  | 1/3 | 1/0 | 1/3  | 1/1 | 1/2 | 1/2 | 1/1 | 3/4 | 1/2      | 1/3      | 3/0 | 1/3        | 1/1 | 1/1  | 1/1  | 1/0  | 3/0     | 3/3 | 0/0 | 1/1  | 1/1  | 1/1  |
| Formaldehyde solution     | CH <sub>2</sub> O   | 000050-00-0   | 40 %        | T           | 1/2      | 2/3  | 1/3 | 1/2 | 1/0  | 1/2 | 1/2 | 1/2 | 4/4 | 2/3 | 2/3      | 3/3      | 0/4 | 1/1        | 1/1 | 1/1  | 1/1  | 1/0  | 3/0     | (3) | 0/0 | 1/1  | 1/1  | 1/1  |
| Formic acid               | CH <sub>2</sub> O <sub>2</sub>                                  | 000064-18-6   | 98-100 %    | C           | 1/1      | 1/2  | 4/4 | 3/4 | 0/0  | 1/3 | 4/4 | 1/3 | 3/4 | 3/3 | 3/4      | 1/3      | 3/4 | 1/1        | (1) | 1/1  | 1/1  | 3/4  | 4/4     | 4/4 | 0/0 | 1/0  | 1/3  | 1/2  |
| Fuel oil                  | —   | —             |             | Xn          | 3/3      | 3/4  | 1/0 | 3/3 | 1/0  | 2/3 | 1/1 | 1/3 | 3/4 | 1/2 | 1/1      | 3/3      | 1/1 | 1/1        | 1/1 | 1/1  | 1/1  | 4/4  | 1/1     | 1/1 | 0/0 | 1/1  | 1/1  | 1/1  |
| Gasoline                  | C <sub>8</sub> H <sub>12</sub> -C <sub>12</sub> H <sub>26</sub> | 086290-81-5   |             | F, Xn, N    | X        | 2/3  | 3/4 | 1/0 | 3/3  | (2) | 2/3 | 1/2 | 3/4 | 4/4 | 3/3      | 2/4      | 0/0 | 0/4        | 1/1 | 1/1  | 1/1  | 4/4  | (1-3)   | 3/0 | 0/0 | 1/1  | 1/1  | 1/1  |
| Hydrogen chloride         | HCl   | 007647-01-0   | 35 %        | C           | 1/1      | 1/1  | 4/4 | 4/4 | (4)  | 1/2 | 4/4 | 1/2 | 3/3 | 1/1 | 2/3      | 3/3      | 1/3 | 1/1        | 1/1 | 1/1  | 1/1  | 3/0  | 1/2     | 4/4 | 0/0 | 4/4  | 4/4  | 4/4  |
| Hydrogen fluoride         | HF  | 007664-39-3   | 70 %        | T+, C       | 0/0      | 1/3  | 4/4 | 4/4 | 4/4  | 0/0 | 4/4 | 1/3 | 4/4 | 4/4 | 1/4      | 3/0      | 0/0 | 0/0        | (1) | 1/1  | 1/1  | 3/4  | (3)     | 4/4 | 0/0 | 4/4  | 4/4  | 4/4  |
| Isopropyl alcohol         | C <sub>3</sub> H <sub>8</sub> O                                 | 000067-63-0   | techn. pure | F           | X        | 1/1  | 1/1 | 1/0 | 1/2  | 1/0 | 1/2 | 1/0 | 1/1 | 2/2 | 1/2      | 1/2      | 4/4 | 1/4        | 1/1 | 1/1  | 1/1  | 1/0  | 1/1     | 3/3 | 0/0 | (2)  | (1)  | (1)  |
| Methyl ethyl ketone (MEK) | C <sub>4</sub> H <sub>8</sub> O                                 | 000078-93-3   |             | F           | X        | 1/3  | 3/4 | 1/0 | 4/4  | 4/4 | 4/4 | 1/2 | 1/3 | 4/4 | 4/4      | 4/4      | 4/4 | 2/3        | 1/1 | 1/1  | 3/4  | 3/0  | 4/4     | 4/4 | 0/0 | (1)  | (1)  | (1)  |
| Nitric acid               | HNO <sub>3</sub>  | 007697-37-2   | 50 %        | C+          | 2/4      | 3/4  | 4/4 | 4/4 | (2)  | 2/4 | 4/4 | 3/4 | 4/4 | 2/3 | 2/3      | 0/0      | 0/3 | 1/1        | 1/1 | 1/1  | 1/1  | 4/4  | 1/0     | 4/4 | 0/0 | 4/4  | 1/2  | 1/2  |
| Nitrohydrochloric acid    | HNO <sub>3</sub> + HCl  | 008007-56-5   |             | C           | 4/4      | 4/4  | 4/4 | 4/4 | 3/3  | 4/4 | 4/4 | 4/4 | 4/4 | 4/4 | 4/4      | 3/4      | 1/1 | (2)        | 1/1 | 3/0  | 4/4  | 4/4  | 4/4     | 0/0 | 4/4 | 4/4  | 4/4  |      |
| Phosphoric acid           | H <sub>3</sub> PO <sub>4</sub>                                  | 007664-38-2   | 85 %        | C           | 1/1      | 1/1  | 4/4 | 1/2 | 0/0  | 1/2 | 4/4 | 1/2 | 1/2 | 1/1 | 1/2      | 1/1      | 1/2 | 1/1        | 1/1 | 1/1  | 1/1  | 3/0  | 1/1     | 4/4 | 0/0 | 4/4  | 2/4  | 1/3  |
| Sodium hydroxide          | NaHO  | 001310-73-2   | 50 %        | C+          | 1/1      | 1/1  | 1/0 | 4/4 | 4/4  | 1/1 | 1/3 | 1/1 | 2/2 | 1/1 | 1/2      | 0/0      | 0/3 | 1/1        | 1/1 | 1/1  | 3/3  | 1/0  | 3/4     | 3/3 | 0/0 | 4/4  | 1/3  | 1/3  |
| Spirits of Turpentine     | —   | 008006-64-2   |             | Xn          | X        | 2/2  | 3/4 | 1/0 | 4/4  | 1/0 | 3/3 | 1/1 | 4/4 | 4/4 | 2/3      | 4/4      | 3/3 | 1/1        | 1/1 | 1/0  | 1/3  | 4/4  | 1/1     | 3/3 | 0/0 | 1/1  | 1/1  | 1/1  |
| Sulfuric acid             | H <sub>2</sub> SO <sub>4</sub>                                  | 007664-93-9   | 95 %        | C+          | 3/4      | 3/4  | 4/4 | 4/4 | 2/2  | 4/4 | 3/4 | 4/4 | 4/4 | 2/4 | 0/0      | 4/4      | 1/1 | 1/1        | 1/1 | 1/1  | 4/4  | 1/1  | 4/4     | 0/0 | 4/4 | 1/3  | 1/3  |      |
| Tetrachloroethylene       | C <sub>2</sub> Cl <sub>4</sub>                                  | 000127-18-4   |             | Xn          | 4/4      | 4/4  | 4/4 | 3/4 | 4/4  | 1/3 | 4/4 | 4/4 | 4/4 | 4/4 | 4/4      | 3/3      | 1/1 | 1/1        | 1/1 | 1/1  | 4/4  | 2/3  | 4/4     | 0/0 | (3) | 0/0  | 0/0  |      |
| Trichloroethylene (TRI)   | C <sub>2</sub> HCl <sub>3</sub>                                 | 000079-01-6   | 100 %       | Xn          | 3/4      | 4/4  | 3/0 | 4/4 | 4/4  | 4/4 | 4/4 | 4/4 | 4/4 | 4/4 | 4/4      | 0/4      | 1/2 | 1/1        | 1/0 | 1/1  | 4/4  | 1/3  | 4/4     | 0/0 | 1/3 | 1/1L | 1/1L |      |
| Vinegar                   | C <sub>2</sub> H <sub>4</sub> O <sub>2</sub>                    | 000064-19-7   |             | (Xi)        | 1/1      | 1/3  | 4/4 | 1/2 | 1/1  | 1/0 | 1/3 | 1/1 | 1/0 | 1/0 | 1/0      | 3/0      | 1/1 | 1/1        | 1/1 | 1/1  | 1/0  | 3/3  | 3/3     | 0/0 | 1/3 | 1/2  | 1/2  |      |
| Xylene                    | C <sub>8</sub> H <sub>10</sub>                                  | 001330-20-7   |             | (F), Xn     | X        | 3/4  | 3/4 | 1/0 | 4/4  | 0/0 | 3/4 | 1/2 | 4/4 | 4/4 | 4/4      | 4/4      | 4/4 | 1/2        | 1/1 | 1/0  | 1/3  | 4/4  | 1/3     | 4/4 | 0/0 | 1/1  | 1/1  | 1/1  |

Two values are given per substance, left number = value at + 20 °C, right number = value at + 50 °C.

1 = resistant, 2 = practically resistant, 3 = partially resistant, 4 = not resistant, 0 = no data available.

K = no general information available; L = danger of pitting or stress-cracking corrosion, values in parentheses are estimated values.

Hazard notes: C = caustic; F = inflammable; F+ = highly inflammable; O = fire-promoting; T = poisonous; T+ = very poisonous; Xn = slightly poisonous; Xi = irritant

## Important note

The tables headed "Chemical resistance of plastics" and "Properties of plastics materials" have been compiled from information from various producers of raw materials. The figures relate exclusively to laboratory tests on raw materials.

Plastics items made from these materials are often subject to influences which cannot be detected in a laboratory test (temperature, pressure, stresses in the material, chemical substances, design features, etc.). For these reasons the figures quoted can serve only as a guideline. In case of doubt we strongly recommend that a test be carried out. No legal claims can be derived from these figures and we disclaim all liability. The chemical and mechanical resistance of a product does not suffice for the assessment of its suitability for use, for example legislation on flammable liquids (explosion protection) is to be taken into particular consideration.

## Detailed table can be downloaded free of charge

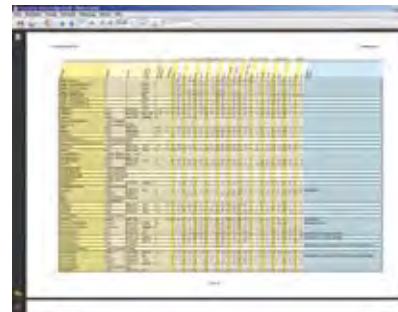

- ▶ More than 1600 media
- ▶ With viscosity table
- ▶ CAS numbers
- ▶ Simple operation
- ▶ Free of charge
- ▶ Download address:  
[www.buerkle.de/chemical-resistance.html](http://www.buerkle.de/chemical-resistance.html)



# Plastics technology | overview of chemical resistance

|                |  |            |                                |             |                         |
|----------------|--|------------|--------------------------------|-------------|-------------------------|
| <b>E-CTFE</b>  | Ethylene-chlorotrifluorethylene (Halar)      | <b>PA</b>  | Polyamide                      | <b>PSU</b>  | Polysulfone             |
| <b>FEP</b>     | Fluorinated ethylene-propylene (Teflon, FEP) | <b>PC</b>  | Polycarbonate                  | <b>PTFE</b> | Polytetrafluoroethylene |
| <b>PETG</b>    | Polyethyleneterephthalate                    | <b>PFA</b> | Perfluoro-alkoxy (Teflon, PFA) | <b>PVC</b>  | Polyvinylchlorid        |
| <b>FPM/FKM</b> | Fluoroelastomer (Viton)                      | <b>PMP</b> | Polymethylpentene (TPX)        | <b>PVDF</b> | Polyvinylidenefluoride  |
| <b>HDPE</b>    | High-density polyethylene                    | <b>PP</b>  | Polypropylene                  | <b>SAN</b>  | Styrene-acrylnitrile    |
| <b>LDPE</b>    | Low-density polyethylene                     | <b>PS</b>  | Polystyrene                    | <b>SI</b>   | Silicone rubber         |

| Plastics abbreviations | Temperature   |              | steam <sup>4)</sup><br>121°C | Sterilization <sup>5)</sup> |                   |     | chemical formalin, ethanol | Transparency | Flexibility | Specific weight g/cm <sup>3</sup> | Water absorption % |
|------------------------|---------------|--------------|------------------------------|-----------------------------|-------------------|-----|----------------------------|--------------|-------------|-----------------------------------|--------------------|
|                        | max. °C<br>1) | min °C<br>2) |                              | gas ethyleneoxide           | radiation 2.5 kGy |     |                            |              |             |                                   |                    |
| E-CTFE                 | + 150°        | - 100°       | yes                          | yes                         | no                | yes | transparent                | moderate     | 1.70        | < 0.10                            |                    |
| FEP                    | + 205°        | - 255°       | yes                          | yes                         | no                | yes | transparent                | very good    | 2.15        | < 0.01                            |                    |
| FPM                    | + 200°        | - 20°        |                              |                             |                   |     | black                      | good         | 1.90        |                                   |                    |
| HDPE                   | + 110°        | - 50°        | no                           | yes                         | yes               | yes | transparent                | stiff        | 0.95        | 0.01                              |                    |
| LDPE                   | + 95°         | - 50°        | no                           | yes                         | yes               | yes | transparent                | excellent    | 0.92        | 0.01                              |                    |
| PA                     | + 90°         | - 0°         | no                           | yes                         | yes               | yes | transparent                | stiff        | 1.13        | 1.30                              |                    |
| PC                     | + 135°        | - 135°       | yes                          | yes                         | yes               | yes | clear                      | rigid        | 1.20        | 0.35                              |                    |
| PFA                    | + 250°        | - 270°       | yes                          | yes                         | no                | yes | transparent                | excellent    | 2.15        | 0.03                              |                    |
| PMP                    | + 175°        | - 150°       | yes                          | yes                         | yes               | yes | glass-clear                | stiff        | 0.83        | 0.01                              |                    |
| PP                     | + 135°        | 0°           | yes                          | yes                         | no                | yes | transparent                | stiff        | 0.90        | 0.02                              |                    |
| PS                     | + 70°         | - 20°        | no                           | no                          | yes               | yes | glass-clear                | stiff        | 1.05        | 0.05                              |                    |
| PSU                    | + 165°        | - 100°       | yes                          | yes                         |                   | yes | clear                      | stiff        | 1.24        | 0.30                              |                    |
| PTFE                   | + 270°        | - 270°       | yes                          | yes                         | no                | yes | white                      | excellent    | 2.25        | < 0.01                            |                    |
| PVC                    | + 70°         | - 30°        | no <sup>3)</sup>             | yes                         | no                | yes | clear                      | stiff        | 1.35        | 0.06                              |                    |
| PVDF                   | + 160°        | - 4°         | yes                          | yes                         | yes               | yes | transparent                | stiff        | 1.78        | 0.04                              |                    |
| SAN                    | + 95°         | - 40°        | no                           | yes                         | no                | yes | glass-clear                | stiff        | 1.03        | 0.05                              |                    |
| SI                     | + 180°        | - 60°        | yes                          | yes                         | no                | yes | transparent                | excellent    | 1.10        |                                   |                    |
| PETG                   | + 70°         | + 5°         | no                           | ?                           | ?                 | yes | glass-clear                | stiff        | 1.78        | 0.70                              |                    |

<sup>1)</sup> Even higher for short periods

<sup>2)</sup> Brittle temperature

<sup>3)</sup> Except PVC hoses, which can be sterilized with steam at a temperature of 121 °C

<sup>4)</sup> Frequent steam sterilization reduces mechanical stability!

<sup>5)</sup> Clean apparatus with distilled water first (to avoid stress cracking corrosion). In the case of closed vessels, remove or slightly open lid, do not close lid tight again until the vessel has cooled down.

| Substance class at 20 °C   | ABS | ECTFE | HDPE | LDPE | PA | PC | PMP | PP | PS | PTFE/FEP/PFA | PVC | SAN | SI |
|----------------------------|-----|-------|------|------|----|----|-----|----|----|--------------|-----|-----|----|
| Aldehydes                  | -   | +     | +    | +    | 0  | 0  | 0   | +  | -  | +            | -   | -   | 0  |
| Alcohols aliphatic         | +   | +     | +    | +    | 0  | +  | +   | +  | +  | +            | +   | +   | +  |
| Esters                     | -   | +     | 0    | 0    | +  | -  | 0   | 0  | -  | +            | -   | -   | 0  |
| Ethers                     | -   | +     | 0    | -    | +  | -  | -   | -  | -  | +            | -   | -   | -  |
| Ketones                    | -   | 0     | 0    | 0    | +  | -  | 0   | 0  | -  | +            | -   | -   | -  |
| Carbohydrates              |     |       |      |      |    |    |     |    |    |              |     |     |    |
| aliphatic                  | -   | +     | +    | 0    | +  | 0  | 0   | +  | -  | +            | +   | -   | -  |
| aromatic                   | -   | +     | +    | 0    | +  | -  | -   | 0  | -  | +            | -   | -   | -  |
| halogenated                | -   | +     | 0    | -    | 0  | -  | -   | 0  | -  | +            | -   | -   | -  |
| Acids, weak/dilute         | 0   | +     | +    | +    | 0  | 0  | +   | +  | 0  | +            | +   | 0   | 0  |
| Acids, strong/concentrated | -   | +     | +    | +    | -  | -  | +   | +  | 0  | +            | +   | -   | -  |
| Acids, oxidising           | -   | 0     | 0    | 0    | -  | -  | 0   | 0  | -  | +            | -   | -   | -  |
| Bases                      | 0   | +     | +    | +    | 0  | -  | +   | +  | -  | +            | +   | +   | +  |

**+ = excellent chemical resistance**

The substance does not result in any damage to the plastic after 30 days of permanent contact. The plastic may remain resistant for years.

**0 = good/limited chemical resistance**

Within 7 to 30 days of permanent contact, the substance provokes minor damage which may be reversible (softening, swelling, reduction of mechanical strength, discolourations).

**- = low chemical resistance**

Not suitable for permanent contact with this substance. Damage to the plastic may occur immediately (reduction of mechanical strength, deformation, discolourations, splits, dissolution, risk of breakage).

## Suitable thread adapters | for many container threads

Plastic barrels and containers can have a wide range of thread types. Some are standardized according to DIN, BSI or US standards. Other threads are manufacturer-specific. We can supply suitable adapters for most containers so that discharge valves, pumps and other accessories can be safely attached.

Various steps are necessary in order to select the correct adapter. Proceed as follows:

### 1. First use the thread table to select the container thread.

If possible use calipers for the measurement, although most threads can be measured accurately enough with a ruler.

If your container has an outer thread you will require an adapter with an inner thread. Containers with an inner thread require adapters with an outer thread.

### 2. In the Adapter overview on page 28 you will find the suitable adapter.

All thread descriptions refer directly to the adapter. This means that if your container has a  $\frac{3}{4}$ " outer thread you will require an adapter with a  $\frac{3}{4}$ " inner thread. If you cannot find the necessary adapter here, or if you cannot determine the thread size, just send us a screw cap and we will send you a suitable adapter.

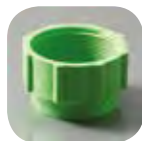

### Example

Your container thread is an outer thread with a diameter of 71 mm. You want to use a PP barrel pump with a barrel screw joint. Use the thread table to determine the type of thread. As it is a 71 mm thread you will require an adapter with a 71 mm inner thread. The barrel screw joint thread is 2" BSP outer. This means that you need an adapter from 71 mm inner to 2" BSP inner. In the Adapter table on page 28 you will then find the corresponding article number 0600-1003.

|    | Internal thread           |
|----|---------------------------|
| 12 | 35 mm - 2" BSP            |
| 13 | 51 mm - 2" BSP            |
| 14 | DIN 61 - 2" BSP           |
| 15 | <del>63 mm - 2" BSP</del> |
| 16 | DIN 71 - 2" BSP           |

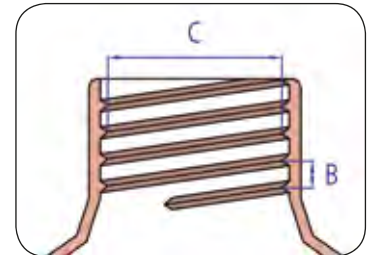
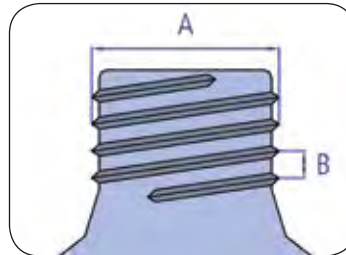

### Threads overview

| A mm  | B mm | C mm | Thread description                         | Thread type |
|-------|------|------|--|-------------|
| 53    | 5    | 50,5 | 51 mm, DIN 51*)                            | sawtooth    |
| 59-60 | 6    | 55,8 | 60 mm, DIN 60                              | sawtooth    |
| 61    | 6    | 55,8 | 61 mm, DIN 61                              | sawtooth    |
| 71    | 6    | 66,5 | 71 mm, DIN 71                              | sawtooth    |
| 59    | 2,2  | 57,5 | 2" BSP/R2" steel drum fine thread          | sawtooth    |
| 64,5  | 5    | 60   | 63 mm, 64 mm BSI                           | sawtooth    |
| 33,5  | 3    | 32,7 | 35 mm                                      | round/std.  |
| 69,5  | 5,5  | 65   | 2" coarse thread Mauser L-Ring             | sawtooth    |
| 56    | 3,5  | 52,5 | Tri-Sure/2" coarse thread v. Leer/Tri-sure | sawtooth    |
| 63,2  | 4,25 | 57,5 | US drum thread                             | sawtooth    |

\*) old and alternative thread names are printed semibold

## Packaging containers with UN approval

### What is a container with UN approval?

The person who fills a package with hazardous materials is responsible for its safety on dispatch. In a UN approved container you can transport hazardous goods safely without having to repack them and thus save costs.

### What is "UN-approved"?

The UN has drawn up a list of more than 6000 hazardous substances classified according to the risk that they represent; this determines their packaging group. Packaging group I (X) corresponds to a high degree of risk represented by the contents, e.g. very corrosive substances; packaging group II (Y) a medium degree of risk and packaging group III (Z) less hazardous substances.

The UN approval describes the type of packaging to be used for the transport of hazardous substances. The certificate is issued by recognized material testing institutes. In mass production the manufacturer must guarantee that the product meets the specifications for the type of packaging and that the packaging is manufactured and tested according to a quality assurance program recognized and monitored by the registration office.

### Test criteria (limits must not be infringed)

- ▶ chemical compatibility
- ▶ temperature
- ▶ flash point < 61 °C
- ▶ drop height
- ▶ pressure (i.e. vapor pressure of the contents plus partial pressure of any gases that may be present)
- ▶ packaging groups I, II, III (density kg/l)
- ▶ shelf life from filling date (if applicable)

### Approval numbers

- ▶ The identification contains the symbol for UN-tested packaging, the code for the container material, packaging group, test pressure in kPa, year of manufacture, country of approval, registration office, approval number and manufacturer.
- ▶ If the approval number contains a letter (e.g. F or S) in the position that would otherwise be occupied by the test pressure in kPa then the packaging is only approved for use with solids, not with liquids.
- ▶ New approval numbers apply for all types of transport, i.e. there is no longer any limitation to road, rail, sea or air transport.



**Wide-neck reagent bottle**  
rectangular/space-saving, sturdy, with UN approval for solids

see page 163



**Transport bottle**  
UN-certified bottle for chemicals

see page 173



**Aluminum bottle**

see page 174



**Aluminium bottle**  
with UN-approval for the transport of dangerous goods

see page 175



**Jerrycans**  
stackable, made of transparent HDPE, space-saving

see page 184



**Jerrycans**  
electrically conductive

see page 185



**Wide-mouth containers**  
extra-wide opening for secure filling

see page 191



1B1 / X / 250 / 15 / D / BAM 1234 XYZ

Symbol for UN-tested packaging

Code for the container material

Packaging group

Test pressure in kPa

Year of manufacture and country of approval

Registration office, approval number and manufacturer

# Contents | alphabetical order

|   |               |  |
|---|---------------|--|
| <b>A</b>  |               |  |
| Accessories for zone samplers                     | 70            |  |
| AccuOne / EnergyOne                               | 34            |  |
| Adapter set Pump-it®                              | 14            |  |
| AISI 304, Scoop                                   | 136           |  |
| All-layer drill                                   | 72            |  |
| All-layer sampler                                 | 69            |  |
| All-layer-scratcher                               | 73            |  |
| All-purpose boxes, round                          | 178           |  |
| All-purpose trays                                 | 200           |  |
| Aluminium bottle                                  | 153, 174      |  |
| Aluminum sampler                                  | 110           |  |
| Angled connectors                                 | 232           |  |
| Angular beaker                                    | 104           |  |
| Anti-static set                                   | 26            |  |
| Apron, Plastic                                    | 58            |  |
| AquaSampler                                       | 119           |  |
| Assistants, Pipette                               | 222           |  |
| <b>B</b>  |               |  |
| Ball valve PP                                     | 48            |  |
| Ball valve PP, food                               | 49            |  |
| Ball valves for barrels                           | 48            |  |
| Barrel key  | 57            |  |
| Barrel pump made of stainless steel               | 21            |  |
| Barrel pump PP                                    | 18            |  |
| Barrel pumps for solvents                         | 24            |  |
| Barrel pumps, Gas-tight                           | 30            |  |
| Barrel pumps, PTFE                                | 17            |  |
| Barrel pump, Stainless steel                      | 20            |  |
| Barrel screw joints                               | 27            |  |
| Barrel valve                                      | 51            |  |
| Battery-powered Hose pump                         | 115           |  |
| Beaker, Angular                                   | 104           |  |
| Beakers, Graduated                                | 211           |  |
| Beakers, Griffin                                  | 212           |  |
| Beakers, Laboratory                               | 212           |  |
| BeefSteaker                                       | 146           |  |
| Big containers                                    | 192           |  |
| Bottle carrier                                    | 173           |  |
| Bottle carrier box                                | 173           |  |
| Bottle holder                                     | 105           |  |
| Bottle pumps                                      | 16            |  |
| Bottles, aluminium                                | 153, 174, 175 |  |
| Bottles, Dropping                                 | 172           |  |
| Bottles, Narrow-necked                            | 156           |  |
| Bottles, Round                                    | 157           |  |
| Bottles, Spray                                    | 169           |  |
| Bottles, UN-approved                              | 173, 175      |  |
| Bottle, Wash                                      | 170           |  |
| Bottle, Wide-necked                               | 164           |  |
| Bottle with child safety lock, narrow neck        | 166           |  |
| Bowls sterilisable                                | 205           |  |
| Bucket HDPE                                       | 207           |  |
| Bucket made of PP                                 | 205           |  |
| Buckets   | 205, 206      |  |
| Buckets, Packaging                                | 196, 207      |  |
| Bungs PE  | 259           |  |
| Burettes  | 218           |  |
| <b>C</b>  |               |  |
| Cables, Lowering                                  | 120           |  |
| Canister pumps                                    | 25            |  |
| Canisters   | 184           |  |
| Carrier box, Bottle                               | 173           |  |
| Cheese sampler                                    | 95            |  |
| Chemistry scoop                                   | 102           |  |
| CheMobil  | 236           |  |
| ChemoSampler                                      | 106           |  |
| Choosing the right pump                           | 4             |  |
| Clamps, Hose                                      | 238           |  |
| close-it control seal                             | 86, 87        |  |
| close-it dispenser                                | 91            |  |
| close-it food & pharma                            | 88            |  |
| close-it tape                                     | 89            |  |
| Compact jerrycan                                  | 182           |  |
| Compact jerrycan & Compact stop cock set          | 46            |  |
| Compact jerrycan & StopCock set                   | 46            |  |
| Compact lever pump                                | 33            |  |
| Compact spigot                                    | 45            |  |
| Connectors  | 231           |  |
| Container pumps                                   | 25            |  |
| Containers, rectangular and round shaped          | 192           |  |
| Containers, Stacking                              | 189           |  |
| Control seal close-it                             | 87            |  |
| Control seal close-it food & pharma               | 88            |  |
| CupSampler, Liquid                                | 106           |  |
| Cylinders, Graduated                              | 214           |  |
| <b>D</b>  |               |  |
| Depth catch net                                   | 105           |  |
| Desiccator  | 256           |  |
| Diaphragm pumps                                   | 40            |  |
| Dipping bottle Ex                                 | 117           |  |
| Dipping bottles                                   | 116           |  |
| Dipping vessel                                    | 118           |  |
| Dip Sampler, plunging siphon                      | 100           |  |
| DispoLance  | 125           |  |
| DispoPicker                                       | 124           |  |
| DispoPipette                                      | 122           |  |
| Disposable plunging siphon                        | 101           |  |
| Disposable samplers                               | 101, 121-134  |  |
| Disposal kegs, wide-mouth containers              | 191           |  |
| DispoTube   | 123           |  |
| Dosing machine                                    | 53            |  |
| Dosing pumps                                      | 16            |  |
| Dosi-Pump   | 16            |  |
| Draining rack, benchtop                           | 225           |  |
| Draining rack, wallmount                          | 224           |  |
| Drain safety stand                                | 57            |  |
| Drill bits for mole                               | 149           |  |
| Drop-Boy  | 172           |  |
| Dropping bottles                                  | 172           |  |
| Drum pump for acids and alkalis                   | 38            |  |
| Drum pump for concentrated acids/alkalis          | 38            |  |
| Drum pump for mineral oils                        | 39            |  |
| Drum pump for solvents                            | 39            |  |
| Dry ice machine                                   | 150, 226      |  |
| <b>E</b>  |               |  |
| EasySampler                                       | 71            |  |
| EasyScoop   | 136           |  |
| Electrically conductive canister with UN approval | 185           |  |
| Electric barrel pump Petro                        | 37            |  |
| Electric pumps                                    | 34            |  |
| Electroconductive, spigot                         | 47            |  |
| EnergyOne   | 35            |  |
| Eye protection / safety goggles                   | 60, 61        |  |
| Eye rinsing bottle                                | 59, 257       |  |
| Eyes Fresh mini eyewash station                   | 59, 257       |  |
| Eyewash station                                   | 59, 257       |  |
| <b>F</b>  |               |  |
| fish-clip   | 260           |  |
| Fittings  | 236           |  |
| Flachmann - the compact jerrycan                  | 182, 183      |  |
| Flat seals  | 57, 251       |  |
| Flow indicators                                   | 236           |  |
| Flow indicators CheMobil PMP                      | 237           |  |
| Flow indicators LiquiMobil SAN                    | 237           |  |
| Flow meters                                       | 40            |  |
| FoodScoop   | 137           |  |
| Foot pump for solvents                            | 24            |  |
| Foot pumps  | 12            |  |
| Four-sided bucket                                 | 205           |  |
| Four-way-connectors                               | 232           |  |
| Funnels   | 208           |  |
| Funnel, Sedimentation                             | 210           |  |
| Funnel stand                                      | 209           |  |
| <b>G</b>  |               |  |
| Gas-tight barrel pump PP                          | 30            |  |
| General pump accessories                          | 57            |  |
| GeoSampler  | 148           |  |
| Gloves, Protective                                | 58, 258       |  |
| Goggles, Safety                                   | 60            |  |
| Graduated beakers, stackable                      | 212           |  |
| Graduated beakers with handle                     | 211           |  |
| Graduated cylinders, tall form                    | 214           |  |
| Graduated cylinders, tall-form, made of SAN       | 214           |  |
| Graduated pipettes                                | 221           |  |
| Griffin beakers                                   | 212           |  |
| Gripping tongs                                    | 258           |  |
| <b>H</b>  |               |  |
| Heat protection                                   | 258           |  |
| Hose clamp Squeeze-Fix                            | 240           |  |
| Hose clips POM                                    | 240           |  |
| Hose couplings                                    | 234           |  |
| Hose cutter                                       | 229           |  |
| Hose pump, Battery-powered                        | 115           |  |
| Hose tubing stop-cock                             | 242           |  |
| HotGrip   | 258           |  |
| <b>I</b>  |               |  |
| IBC discharge valves                              | 52            |  |
| Ice borer   | 147           |  |
| Ice machine, Dry                                  | 150, 226      |  |
| IceSampler  | 146           |  |
| Immersion cylinder                                | 117           |  |
| Indicators, Flow                                  | 236           |  |
| Instrument servers                                | 204           |  |
| Instrument trays                                  | 204           |  |
| <b>J</b>  |               |  |
| Jerrycan, compact                                 | 182           |  |

|   |        |   |        |  |               |  |          |
|---|--------|---|--------|--|---------------|--|----------|
| Jerrycan pumps                                | 25     | Meat sampler                                | 146    | Packaging bucket                         | 196, 207      | Pumps, Canister                          | 25       |
| Jerrycans                                     | 184    | Mercury collector                           | 256    | PastoFill filler for pasty substances    | 56            | Pumps, Container                         | 25       |
| Jerrycans, Safety                             | 194    | MicroDispo                                  | 125    | Peleus ball                              | 222           | Pumps for petrochemicals                 | 31       |
| Jerrycans, Storage                            | 184    | MicroSampler                                | 80     | Pendulum beaker PP                       | 104           | Pumps for solvents                       | 24, 25   |
| Jerrycans, Wide-necked                        | 186    | Milky                                       | 83     | Pendulum beaker stainless steel          | 104           | Pumps, Vacuum                            | 254      |
| Jumbo sampler                                 | 70     | Mini immersion cylinder                     | 118    | Petrochemicals, Pumps for                | 31            | Pürckhauer                               | 148      |
|   |        | MiniSampler                                 | 108    | PE tubing                                | 228           | PVC bung                                 | 259      |
| <b>K</b>                                      |        | MiniSampler PE                              | 109    | Pharmaceutical products, Samplers for    | 79            | PVC industrial tubing                    | 227      |
| Kegs, Disposal                                | 191    | MiniSampler PTFE                            | 109    | PharmaPicker                             | 81            | PVC pressure tubing                      | 227      |
|   |        | Mini solvent pump                           | 22, 23 | PharmaScoop                              | 137           |  |          |
| <b>L</b>                                      |        | MiniTherm                                   | 150    | PharmaSpoon                              | 82, 135       | <b>Q</b>                                 |          |
| LaboPlast® Bio scoop                          | 141    | Mini ViscoSampler                           | 97     | Photographic trays                       | 202, 203      | QualiRod conical                         | 95       |
| LaboPlast® Bio spatula                        | 142    | Mixing/dosing container                     | 190    | Pigment lance                            | 94            | QualiRod cylindrical                     | 95       |
| LaboPlast® Bio spoon                          | 143    | Mole with handle and bar                    | 149    | Pipette assistants                       | 222           | QualiSampler set                         | 98       |
| LaboPlast® scoop, disposable                  | 141    | Multi-Bottles with graduation               | 165    | Pipette basket                           | 223           | QuickPicker                              | 85       |
| LaboPlast® spatula, disposable                | 142    | MultiDispo                                  | 126    | Pipette rinsing system                   | 223           |  |          |
| LaboPlast® spoon, disposable                  | 143    | Multi sampler                               | 69     | Pipettes                                 | 221           | <b>R</b>                                 |          |
| Laboratory beakers/Griffin beakers, PP        | 212    |   |        | Pipette stand                            | 223           | Rack, Draining                           | 224      |
| Laboratory bottle PET sterile                 | 160    | <b>N</b>                                    |        | Pipetting-ball, Safety                   | 222           | Racks, Test-tube                         | 225      |
| Laboratory bottles with graduation PC         | 160    | Narrow-necked bio-bottles PE                | 159    | Pi-Pump                                  | 222           | Rapid couplings                          | 244      |
| Laboratory bucket                             | 206    | Narrow-necked square bottle                 | 161    | Piston pump PP                           | 33            | Reagent bottle                           | 162      |
| Laboratory pump mains operated                | 36     | Narrow-neck reagent bottle                  | 162    | Piston pump, Rotary                      | 31            | Reducing hose connectors                 | 234      |
| Laboratory pump, rechargeable battery         | 34     | Nipple                                      | 252    | Plastic apron made of PVC                | 58            | Reels, Manually-operated                 | 120      |
| Laboratory trays / spill throughs set         | 201    | Non-return valves PP                        | 243    | Plastic bag                              | 132, 196, 197 | Rotary piston pumps                      | 31       |
| Leakproof wash bottle                         | 171    | Non-return valves with conical inlet/outlet | 243    | Plastic scoops and scrapers              | 144, 145      | Round bottles with snap closure          | 157      |
| Lever pump                                    | 32     |   |        | Plunging siphon, Disposable              | 101           | Rubber bung                              | 259      |
| Lever pump aluminium                          | 31     | <b>O</b>                                    |        | PowderDispo                              | 124           | Rubiflex protective gloves               | 258      |
| Lever pump with galvanised steel piston rod   | 32     | Oil-free double-diaphragm pump              | 40     | Powder funnels PP/PE                     | 209           |  |          |
| Liquid CupSampler                             | 106    | Oil pump                                    | 31     | PowderProof®                             | 74, 75        | <b>S</b>                                 |          |
| LiquiDispo                                    | 122    | OTAL® battery-pump                          | 11, 13 | PP barrel pump - discharge hose/stopcock | 19            | safe-it                                  | 92       |
| Liquid-Sampler                                | 103    | OTAL® foot pump made of PP                  | 13     | PP barrel pump - discharge tube          | 19            | SafetyBox                                | 58       |
| LiquiMobil                                    | 236    | OTAL® foot pump made of PVDF                | 13     | PP barrel pumps                          | 18, 19        | Safety cans stainless steel              | 194      |
| LiquiSampler                                  | 99     | OTAL® foot pump made of stainless steel     | 13     | Pressure sprayer                         | 170           | Safety funnel stainless steel            | 210      |
| LiquoFill filler for fluids                   | 54, 55 | OTAL® foot pumps                            | 12, 13 | ProfiSampler                             | 110, 111      | Safety is the top priority               | 4        |
| LiquoFill filler, manual mode of operation    | 55     | OTAL® foot pump with hose and stopcock      | 13     | ProfiSampler Aluminium                   | 111           | Safety jerrycans stainless steel         | 194      |
| LiquoFill filler, pneumatic mode of operation | 55     | OTAL® hand pump made of PP                  | 11     | Profi Sampler PP                         | 111           | Safety pipetting-ball                    | 222      |
| LiquoFill pro filler, semi-automatic drive    | 55     | OTAL® hand pump made of PVDF                | 11     | Protective gear                          | 58, 258       | Safety stand                             | 57       |
| Lowering cables                               | 120    | OTAL® hand pump made of stainless steel     | 11     | Protective gloves                        | 58, 258       | Safety storage container stainless steel | 195      |
|   |        | OTAL® hand pumps                            | 10, 11 | PTFE barrel pumps Ultrapure              | 17            | Safety wash bottle                       | 171      |
| <b>M</b>                                      |        | OTAL® hand pump with hose and stopcock      | 11     | PTFE Scoop                               | 101           | Sample beaker with cover                 | 152, 181 |
| Magic Box                                     | 235    | OTAL® liquid transfer pumps                 | 9      | PTFE tape                                | 57            | Sample boxes, aseptic                    | 151, 179 |
| Magnetic centrifugal pumps                    | 41     | OTAL® mini pump made of PP                  | 11     | PTFE tubing                              | 228           | Sample container, round                  | 151, 180 |
| Magnetic stirring bars                        | 261    |   |        | Pump accessories                         | 27            | Sample containers                        | 151      |
| Manually-operated reels                       | 120    | <b>P</b>                                    |        | Pump capacity                            | 4             | Sampler, All-layer-                      | 69       |
| Measuring jugs industrial                     | 216    | Packaging bags with closure                 | 196    | PumpMaster container pumps               | 14            | Sampler for ground water                 | 119      |
| Measuring scoops                              | 139    | Packaging bottle                            | 156    | Pump-it® container pump                  | 15            | Sampler for silos                        | 77       |
|   |        |   |        | Pump, Piston                             | 33            |  |          |
|   |        |   |        | Pump, Rotary piston                      | 31            |  |          |
|   |        |   |        | Pump safety stand                        | 57            |  |          |

|                                      |          |   |          |   |                    |  |            |
|--------------------------------------|----------|---|----------|---|--------------------|--|------------|
| Sampler, Ice                         | 146      | Spigot „Brass“  | 50       | Syringe, SteriPlast®                      | 134                | VacuMan vacuum pump                                | 254        |
| Sampler, LiquidCup                   | 106      | Spigot Jumbo, with tap                                | 51       |   |                    | Vacuum samplers                                    | 108        |
| Sampler Liquid CupSampler            | 106      | Spill throughs  | 200      | <b>T</b>                                  |                    | Valve lance  | 94         |
| Sampler, Multi                       | 69       | Spiraluis   | 71       |   |                    | Valves, Ball                                       | 48         |
| Samplers for acids                   | 106      | Splinter-proof titrating burette                      | 219      | Tamper proof labels safe-it and secure-it | 92                 | Valves, Two-way and three way                      | 241        |
| Samplers for pharmaceutical products | 79       | Spoon, AISI 304                                       | 135      | Tamper proof labels secure-it             | 93                 | Vampire Sampler                                    | 115        |
| Samplers for tanks                   | 108, 114 | Spoon, Pharma   | 82, 135  | Tape, Sealing                             | 57                 | ViscoDispo   | 123        |
| Sampler, soil                        | 148      | Spoons, Volumetric                                    | 139      | TargetDispo                               | 127                | ViscoSampler                                       | 98         |
| Sampler Tubus                        | 83       | Spray bottle  | 168      | Target immersion cylinder                 | 119                | Volumetric spoons                                  | 139        |
| SampleSafe seal                      | 93       | Spray bottle Turn „n“ Spray                           | 169      | T-connectors                              | 231                |  |            |
| Sample-spoon                         | 135      | Spray bottle with pump vaporizer                      | 167      | TeleScoop                                 | 104, 105           | <b>W</b>   |            |
| Sample tubes aseptic, with seal      | 151, 180 | Sprayer, Pressure                                     | 170      | Telescopic rod                            | 104                | Wall-mounted dosing machine                        | 53         |
| Sampling bag SteriBag                | 132      | Stacking containers                                   | 189      | Temperature control                       | 150                | Wash bottle  | 170, 171   |
| Sampling bag, sterilised             | 132, 197 | Stainless Steel Barrel Pump                           | 20, 21   | Test-tube racks                           | 225                | Water-jet pump                                     | 255        |
| Sampling lance Milky                 | 83       | Stainless steel barrel pump - discharge hose/stopcock | 21       | The bung has to fit!                      | 9                  | Wax sampler  | 95         |
| Scoop AISI 304                       | 136      | Stainless steel barrel pump - discharge tube          | 21       | Thread adapters LaboPlast® 3/4“           | 29                 | Wide-mouth containers                              | 191        |
| Scoop for food                       | 137      | Stainless steel barrel pumps                          | 24       | Thread adapters PP                        | 28                 | Wide-mouth containers, HDPE                        | 191        |
| Scoop PTFE                           | 101      | Stainless steel beaker                                | 105      | Threaded fittings                         | 250, 251, 252, 253 | Wide-mouth containers with handle                  | 188        |
| Scoops and scrapers for foodstuffs   | 144      | Stainless steel measuring spoons                      | 138      | Thread fittings                           | 244                | Wide-necked bottle                                 | 164        |
| Scoops and scrapers for industry     | 145      | Stainless steel, Safety jerrycans                     | 194      | Three-way valves                          | 241                | Wide-necked boxes, round                           | 176        |
| Scoops, Chemistry                    | 102      | Stainless steel scoop                                 | 97, 102  | Titrating burette automatic               | 218                | Wide-necked boxes, square shaped                   | 177        |
| Scoop, Stainless steel               | 97, 102  | Stainless steel spatula                               | 96       | Transport bottle aluminium UN             | 175                | Wide-necked jerrycans w/without threaded connector | 186        |
| Scoops, Tele                         | 104      | Stainless steel spigot                                | 50       | Transport case for straight suction tubes | 111                | Wide-necked square bottle                          | 165        |
| Scratcher                            | 73       | Standard bungs  | 259      | Transport containers                      | 189                | Wide-necked wash bottle                            | 171        |
| Screw cap, Tubes with                | 152, 176 | Standardised containers                               | 189      | Transport trolley for containers          | 189                | Wide-neck reagent bottle                           | 163        |
| Sealable wide-necked bottles         | 153, 166 | Stand, Funnel   | 209      | Trays, Instrument                         | 204                |  |            |
| Sealing tape                         | 57       | SteriBag  | 132, 197 | Trays, Laboratory                         | 200                | <b>Y</b>   |            |
| seal-it                              | 91       | SteriBag StandUp                                      | 133, 197 | Trays, Photographic                       | 202                | Y-connectors                                       | 231        |
| Seals, Flat                          | 57, 251  | SteriBag StandUp sample bag                           | 133, 197 | Tubes with screw cap                      | 152, 176           |  |            |
| secure-it                            | 93       | SteriPlast® Bio sample spatula                        | 130      | Tubing Clamps                             | 238                | <b>Z</b>   |            |
| security seal                        | 91       | SteriPlast® Bio sample spoon                          | 131      | Tubings                                   | 227                | ZoneDispo  | 127        |
| Sedimentation funnel                 | 210      | SteriPlast® sample scoop                              | 129      | Tubs, round                               | 190                | Zone samplers                                      | 68, 69, 70 |
| Servers, Instrument                  | 204      | SteriPlast® sample spatula                            | 130      | Tubus                                     | 83                 | Zone sampler Spiraluis                             | 71         |
| Silicone bungs                       | 259      | SteriPlast® sample spoon                              | 131      | Two-way valves                            | 241                |  |            |
| Silicone tubing                      | 229      | SteriPlast® sampling tube                             | 134, 181 | <b>U</b>                                  |                    |  |            |
| SiloDrill                            | 76, 77   | SteriPlast® syringe                                   | 134      | Ultrapure Barrel pumps                    | 17                 |  |            |
| Silo sampler SiloPicker              | 78       | StickProof  | 82       | UN-Bottle                                 | 173                |  |            |
| Single mark pipettes                 | 221      | Stirring bars, Magnetic                               | 261      | UniSampler „Ex“                           | 113                |  |            |
| Siphon with stopcock                 | 42       | Stirring paddle                                       | 261      | UniSampler with hose                      | 113                |  |            |
| SnowPack® dry ice machine            | 226      | StopCock PA, electroconductive                        | 47       | UniSampler with suction lance             | 114                |  |            |
| Soil sampler GeoSampler              | 148      | StopCocks   | 44       | Universal graduated beakers               | 217                |  |            |
| Soil sampler Puerckhauer             | 148      | stop-it hose clamps                                   | 238      | Universal storage containers              | 188                |  |            |
| soil sampling                        | 148      | stop-it metal   | 239      | Uno sampler                               | 69                 |  |            |
| Solvent pump foot operated           | 24       | stop-it with Easy-Click closure                       | 239      |   |                    |  |            |
| Solvent pump hand operated           | 25       | Storage and stacking containers                       | 189      | <b>V</b>                                  |                    |  |            |
| Solvent pumps                        | 24       | Storage bottles, w/without threaded connector         | 187      | VacuMan vacuum or pressure pump           | 254                |  |            |
| Spatula                              | 96       | Storage jerrycans                                     | 184      |   |                    |  |            |
| Spectacles, Safety                   | 60       | Straight suction tubes for ProfiSampler               | 111      |   |                    |  |            |
| Spigot „Air“                         | 49       | Surface catch net                                     | 105      |   |                    |  |            |

# Contents | by item no.

| Item no.  | Page                          | Item no.                                    | Page                         | Item no.                                   | Page                            | Item no. | Page                       | Item no. | Page            | Item no. | Page                      |
|---|-------------------------------|---|------------------------------|--|---------------------------------|----------|----------------------------|----------|-----------------|----------|---------------------------|
| 0006-23, 24, 48, 49, <b>57</b> , 75, 78, 81, 109, 227, 228, 229 |                               | 2327-                                       | 196, <b>207</b>              | 5331-                                      | <b>98</b>                       | 5700-    | <b>36, 38, 40</b>          | 8535-    | 36, <b>253</b>  | 8770-    | 249                       |
| <b>0300-</b>  | 157, <b>161</b>               | 2348-                                       | 82, <b>196</b>               | 5334-                                      | 138, 139                        | 5762-    | 38                         | 8536-    | 253             | 8771-    | 249                       |
| 0301-   | 165                           | 2350-                                       | 205                          | 5336-                                      | 106                             | 5763-    | 39                         | 8537-    | 57, <b>251</b>  | 8772-    | 249                       |
| 0302-   | 156                           | 2502-                                       | <b>60, 61</b>                | 5338-                                      | 82                              | 5765-    | 40                         | 8538-    | 57, <b>251</b>  | 8773-    | 249                       |
| 0303-   | 159                           | 2507-                                       | 17, 58, <b>59</b> , 257, 258 | 5339-                                      | 146                             | 5766-    | 41                         | 8539-    | 57, <b>251</b>  | 8774-    | 249                       |
| 0304-   | 173                           | 2515-                                       | 59, <b>257</b>               | 5340-                                      | 78                              | 5780-    | 37                         | 8540-    | 243             | 8775-    | 249                       |
| 0306-   | 172                           | 2601-                                       | <b>194, 195, 210</b>         | 5341-                                      | 97                              | 5900-    | 35, 36                     | 8545-    | 48, <b>250</b>  | 8780-    | 245                       |
| 0307-   | 172                           | 3414-                                       | 189                          | 5344-                                      | 132, 133, <b>197</b>            | 5912-    | 53                         | 8546-    | 250             | 8781-    | 245                       |
| 0308-   | 157                           | 3418-                                       | 188                          | 5346-                                      | 81                              | 5913-    | <b>55, 56</b>              | 8547-    | 48, <b>250</b>  | 8782-    | 245                       |
| 0309-   | <b>167</b> , 168, 169, 170    | 3440-                                       | <b>192, 193</b>              | 5347-                                      | 73                              | 6202-    | 178                        | 8548-    | 49, 250, 251    | 8783-    | 245                       |
| 0310-   | 170, 171                      | 3460-                                       | 190                          | 5350-                                      | <b>148, 149</b>                 | 6203-    | 151, <b>180</b>            | 8605-    | 241             | 8801-    | 227                       |
| 0314-   | 157                           | 3482-                                       | 190                          | 5351-                                      | 73                              | 6205-    | 109, 151, 180              | 8606-    | 241             | 8802-    | 227                       |
| 0316-   | 160                           | 3490-                                       | 193                          | 5353-                                      | 102                             | 6206-    | 134, 151, <b>179</b> , 181 | 8607-    | 241             | 8803-    | 229                       |
| 0317-   | 188                           | 3600-75, 78, 79, 85, 94, 95, 146, 149       |                              | 5354-                                      | 97, 102, 105                    | 6207-    | 151, <b>180</b>            | 8608-    | 241             | 8804-    | 23, 109, <b>228</b>       |
| 0318-   | 75, 85, 115, <b>164</b>       | 4201-                                       | 200, 201                     | 5355-                                      | 105                             | 6210-    | 178                        | 8610-    | 242             | 8805-    | 109, 111, 115, <b>228</b> |
| 0319-   | 85, 111, 113, 114, <b>164</b> | 4202-                                       | 203                          | 5356-                                      | 136                             | 6214-    | 152, <b>176</b>            | 8614-    | 242             | 8875-    | 227                       |
| 0320-   | 164                           | 4203-                                       | 203                          | 5357-                                      | 106                             | 6250-    | 178                        | 8618-    | 240             | 8876-    | 227                       |
| 0322-   | 153, 166                      | 4206-                                       | 203                          | 5358-                                      | 79                              | 6282-    | 176                        | 8619-    | 239             | 8878-    | 111, 115, <b>228</b>      |
| 0327-   | 153, 174                      | 4207-                                       | 203                          | 5359-                                      | 94                              | 7102-    | 211                        | 8677-    | 240             | 8879-    | 23, 228                   |
| 0329-   | 175                           | 4230-                                       | 204                          | 5360-                                      | 71                              | 7103-    | 152, <b>181</b>            | 8678-    | 240             | 8881-    | 229                       |
| 0331-   | 161                           | 4702-                                       | 205                          | 5365-                                      | <b>116</b> , 117, 118, 119      | 7104-    | 211                        | 8700-    | <b>233, 234</b> | 9602-    | 208                       |
| 0332-   | 161                           | 5000-                                       | 13                           | 5369-                                      | 94                              | 7109-    | 217                        | 8701-    | 233             | 9606-    | 209                       |
| 0338-   | 165                           | 5005-                                       | 11, 13                       | 5370-                                      | 136                             | 7110-    | 212                        | 8703-    | 234             | 9614-    | 139                       |
| 0340-   | 109, <b>162</b>               | 5201-                                       | 14                           | 5371-                                      | 137                             | 7118-    | 210                        | 8704-    | 234             | 9622-    | 208, <b>209</b>           |
| 0341-   | 166                           | 5202-                                       | 15                           | 5378-129, <b>130, 131</b> , 141, 143       |                                 | 7122-    | 212                        | 8705-    | 231             | 9635-    | 225                       |
| 0342-   | 106, <b>163</b>               | 5301-                                       | 77                           | 5379-130, 131, 141, 142, 143               |                                 | 7204-    | 216                        | 8706-    | 231             | 9640-    | <b>224, 225</b>           |
| 0355-   | 177                           | 5302-                                       | <b>75, 115</b>               | 5380-                                      | <b>78, 81</b>                   | 7210-    | 216                        | 8707-    | 232             | 9650-    | 223                       |
| 0356-   | 177                           | 5303-83, 85, <b>87, 88</b> , 89, 91, 92, 93 |                              | 5382-                                      | 83                              | 7502-    | 215                        | 8708-    | 232             | 9668-    | 255                       |
| 0357-   | 177                           | 5304-                                       | <b>70, 71, 72</b> , 98, 99   | 5383-                                      | 96                              | 7503-    | 215                        | 8710-    | <b>233</b>      | 9695-    | <b>218</b> , 219          |
| 0361-   | 173                           | 5305-                                       | 109, 111                     | 5384-                                      | 150                             | 7506-    | 214                        | 8711-    | 231             | 9760-    | 259                       |
| 0370-   | 160                           | 5307-                                       | 80                           | 5387-                                      | 101                             | 7550-    | 221                        | 8712-    | 231             | 9763-    | 259                       |
| 0401-   | 187                           | 5308-                                       | 119                          | 5388-                                      | 146                             | 7551-    | 222                        | 8713-    | 232             | 9764-    | 259                       |
| 0402-   | 187                           | 5309-                                       | 120                          | 5389-                                      | 101                             | 7553-    | 221                        | 8714-    | 235, <b>243</b> | 9768-    | 258                       |
| 0431-   | 186                           | 5310-                                       | 72                           | 5393- <b>122, 123</b> , 124, 125, 126, 127 |                                 | 7554-    | 222                        | 8715-    | 235             | 9789-    | 256                       |
| 0435-   | 46, <b>183</b>                | 5311-                                       | 95                           | 5399-                                      | <b>91, 93</b> , 166, 191        | 7555-    | 220                        | 8717-    | 232             | 9791-    | 256                       |
| 0500-   | 48, 49                        | 5313-                                       | 96                           | 5600-                                      | 17, 19, <b>21, 27</b> , 35, 36  | 7556-    | 220                        | 8720-    | 237             | 9805-    | 150, <b>226</b>           |
| 0525-   | <b>44, 47</b> , 183, 192      | 5314-                                       | 23, <b>111</b> , 113, 114    | 5601-                                      | 21, 27                          | 8203-    | 261                        | 8740-    | 246             |          |                           |
| 0530-   | <b>45</b> , 183, 192          | 5315-                                       | 100                          | 5602-                                      | 21, 24, 25, <b>26, 31</b> , 111 | 8271-    | 260, <b>261</b>            | 8741-    | 246             |          |                           |
| 0533-   | 49                            | 5316-                                       | 69                           | 5603-                                      | 23, 24, 25                      | 8280-    | 260                        | 8742-    | 246             |          |                           |
| 0534-   | 51, 52                        | 5317-                                       | <b>69, 70</b>                | 5605-                                      | 42                              | 8300-    | <b>144, 145</b>            | 8743-    | 246             |          |                           |
| 0535-   | 50                            | 5318-                                       | 71                           | 5606-                                      | 17                              | 8501-    | 252                        | 8744-    | 246             |          |                           |
| 0536-   | 51                            | 5319-                                       | 70                           | 5607-                                      | 16                              | 8502-    | 252                        | 8750-    | 247             |          |                           |
| 0600-   | 14, 28, 29, 48, 183           | 5320-                                       | 135                          | 5610-                                      | 30                              | 8505-    | 252                        | 8751-    | 247             |          |                           |
| 1105-   | 191                           | 5321-                                       | 83                           | 5611-                                      | 30                              | 8506-    | 252                        | 8752-    | 247             |          |                           |
| 1406-   | 191                           | 5322-                                       | 85                           | 5613-                                      | 32, 33                          | 8510-    | 253                        | 8753-    | 247             |          |                           |
| 1427-   | 184                           | 5323-                                       | 147                          | 5618-                                      | 19, 21, 57, 97, 98              | 8515-    | 252                        | 8754-    | 247             |          |                           |
| 1428-   | 185                           | 5324-                                       | <b>82</b> , 135, 137         | 5620-                                      | 254                             | 8516-    | 252                        | 8755-    | 247             |          |                           |
| 2306-   | 205, <b>206</b>               | 5325-                                       | 134                          | 5625-                                      | 41, 255                         | 8520-    | 253                        | 8760-    | 248             |          |                           |
| 2307-   | 207                           | 5326-                                       | 103                          | 5626-                                      | 31                              | 8525-    | 253                        | 8761-    | 248             |          |                           |
| 2308-   | 206                           | 5327-                                       | 115                          | 5627-                                      | 31                              | 8530-    | 253                        | 8762-    | 248             |          |                           |
|   |                               | 5330-                                       | 98, <b>99</b>                | 5690-                                      | 21, <b>57</b>                   | 8533-    | 49, <b>251</b>             | 8763-    | 248             |          |                           |

## Splinter-proof titrating burette

The glass burette has a plastic sheathing which increases resistance to breaking and protects against splinters. The possibility of the burette breaking is much lower than with a conventional burette, and if it does break, there will be no dangerous splinters.

- ▶ Burette with splinter-proof sheathing
- ▶ Adjusted to Ex
- ▶ Burette made of borosilicate glass 3.3
- ▶ Shatter-proof, resistant to chemicals
- ▶ Sturdy stand
- ▶ Precise discharge jet, allowing very fine drops



Page 219



Your order telephone  
Phone +49 (0) 7635 82795-0  
Fax +49 (0) 7635 82795-31

**bürkle**

9997-1041

**Bürkle GmbH**  
Rheinauen 5  
79415 Bad Bellingen  
Germany  
info@buerkle.de  
www.buerkle.de

